

# fischertechnik mot. 3

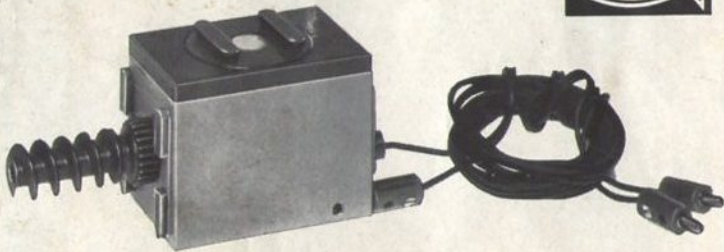

Nur für Gleichstrom! (3 - 6 Volt, max. 500mA)  
For DC only! (3 to 6 volts, max. 500mA)

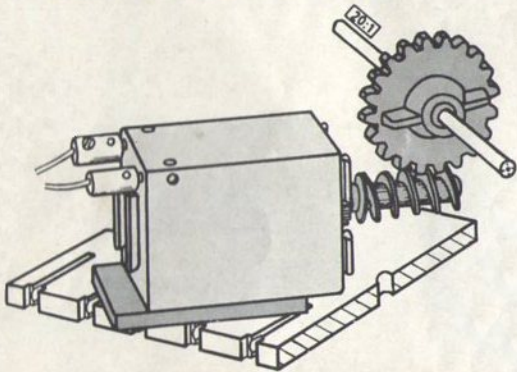

Pour C.C. seulement! (3 à 6 volts, max. 500mA) ● Per

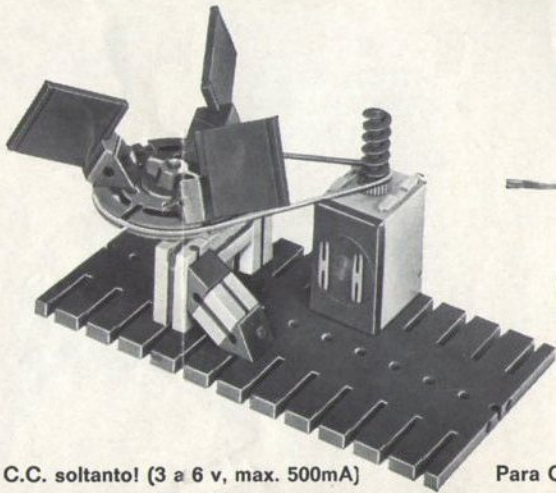

**C.C. soltanto! (3 a 6 v, max. 500mA)**

**Para C**



**C.C. únicamente! (3 a 6 voltios, max. 500mA)**

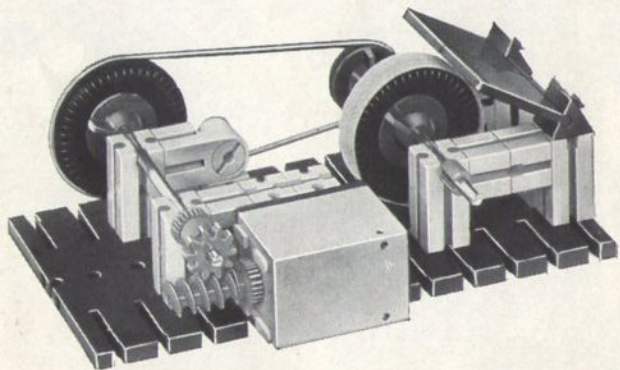

● Endast för Likström! (3-6 Volt, max. 500mA)

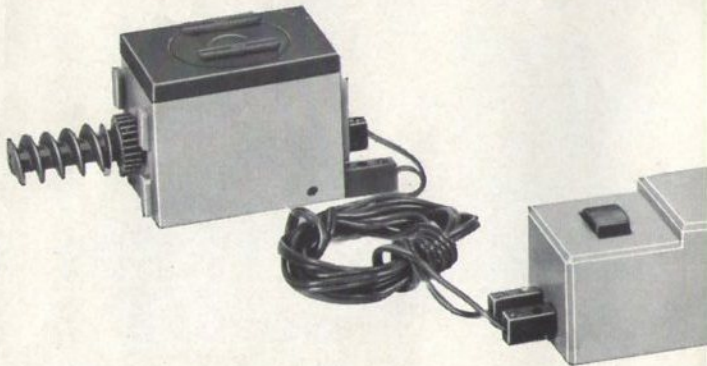

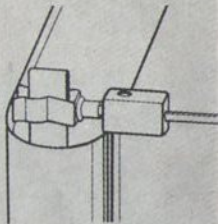
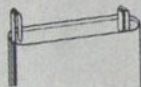



fischertechnik e-m 1

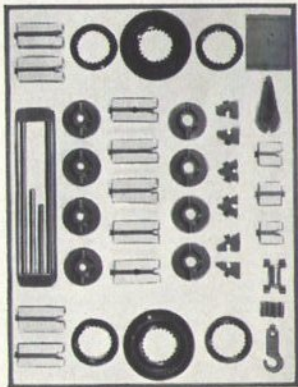

fischertechnik 50





fischertechnik e-m 2

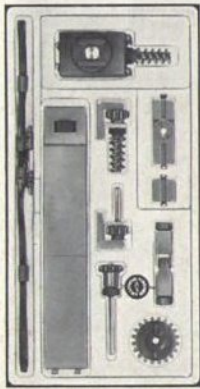

fischertechnik mot. 1

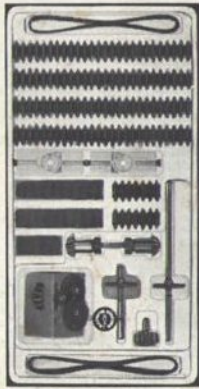

fischertechnik mot. 2