

















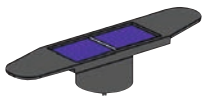



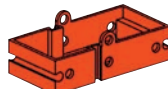



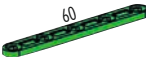

fischertechnik 

ADVANCED

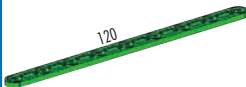

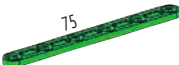
Solar

3 MODELS

	31 670 2 x		36 323 12 x		116 252 1 x
	31 690 1 x		36 324 2 x		145 415 1 x
	31 848 12 x		36 334 2 x		145 416 1 x
	31 978 1 x		36 912 1 x		146 529 1 x
	31 982 4 x		37 238 6 x		146 531 4 x
	31 984 1 x		37 468 6 x		146 532 2 x
	32 064 4 x		38 428 2 x		146 533 2 x
	35 049 4 x		38 543 4 x		156 502 2 x
	35 806 1 x		116 251 1 x		163 202 2 x

- Alle Einzelteile, insbesondere bewegliche Teile sind falls notwendig zu warten und zu reinigen.
- All components, especially moving parts, should be maintained and cleaned as necessary.
- Toutes les pièces détachées et en particulier les pièces mobiles, sont, si nécessaire, à entretenir et à nettoyer.
- Alle onderdelen, vooral de bewegende delen, kunnen, indien noodzakelijk, onderhouden en gereinigd worden.
- Es necesario limpiar y mantener en buen estado todas las diferentes piezas -especialmente las piezas móviles.
- Caso necessário, todas as peças individuais, especialmente peças móveis, tem que ser submetidas à manutenção e ser limpas.
- Se necessario, tutti i singoli componenti, soprattutto le parti mobili, si devono eventualmente sottoporre a manutenzione e pulizia.
- Případně udržujte a čistěte veškeré jednotlivé součásti, zvláště pohyblivé díly.
- Все детали, особенно подвижные, требуют ухода и чистки.

- Achtung! Verletzungsgefahr an Bauteilen mit funktionsbedingten scharfen Kanten und Spitzen!
- Caution! Be careful not to hurt yourself on components with sharp or pointed edges!
- Attention! Risque de blessure sur les éléments comportant des arêtes et o pointes vives indispensables au bon fonctionnement!
- Let op! U kunt zich bezeren aan bouwstenen met scherpe randen of punten!
- Attenzione! Esiste il pericolo di lesione con i pezzi di costruzione che hanno bordi e punte spigolosi necessari per la funzionalità del pezzo!
- Atenção! Perigo de ferimentos em peças componentes com cantos vivos e pontas obrigatórios para o funcionamento!
- Attenzione! Pericolo di lesioni dovute a componenti con spigoli vivi e punte per motivi funzionali!
- Pozor! Nebezpečí zranění při kontaktu s ostrými hranami a hroty dílů stavebnice!
- Будьте осторожны! Об острые края деталей и и наконечники можно порезаться!

- Die Solarzellen funktionieren bei Sonnenlicht oder mit einer Halogenlampe. Energiesparlampen oder Leuchtstoffröhren sind nicht geeignet.
- The solar cells work with sunlight or with a halogen light. CFL bulbs or fluorescent lights are not suitable.
- Les cellules solaires fonctionnent si elles sont exposées aux rayons du soleil ou à la lumière d'une lampe halogène. Les lampes à faible consommation d'énergie ou les tubes fluorescents ne sont pas appropriés.
- De zonnecellen werken op zonlicht of met behulp van een halogeenlamp. Spaarlampen of TL-lampen zijn niet geschikt.
- Las celdas solares funcionan con luz solar o una lámpara halógena. Lámparas de ahorro de energía o tubos fluorescentes no son apropiados.

- As células solares funcionam com luz solar ou uma lâmpada de halogênio. Lâmpadas economizadoras de energia ou lâmpadas fluorescentes não são adequadas.
- Le celle solari funzionano con la luce del sole o con una lampada alogena. Le lampade a risparmio energetico e i tubi fluorescenti non sono adatti.
- Solární panely fungují při nabíjení slunečním světlem nebo světlem z halogenové lampy. Lampy s energeticky úspornými žárovkami nebo zářivky nejsou vhodné.
- Солнечные элементы работают от солнечного света или галогенной лампы. Энергосберегающие и люминесцентные лампы не подходят.

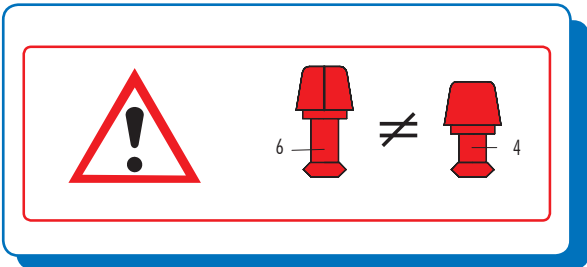
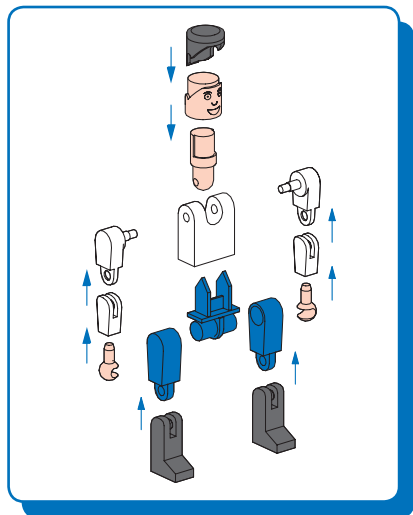
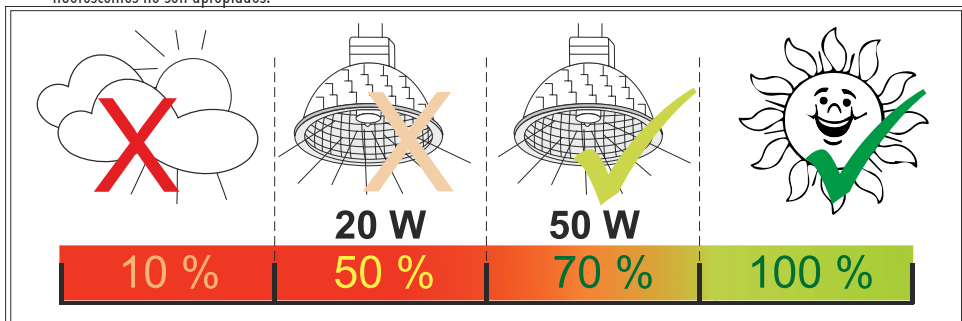

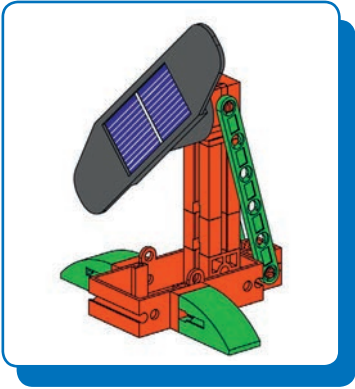

1

	1x		2x
	1x		1x
			2x

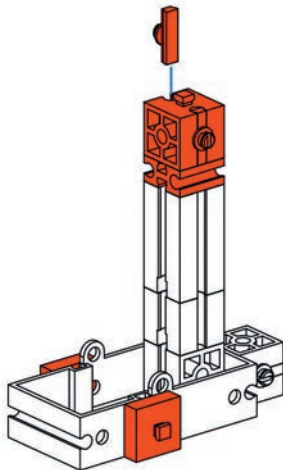
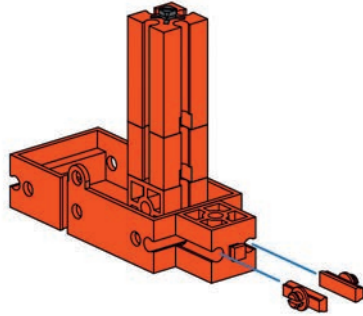

2



	1x		1x
	2x		2x

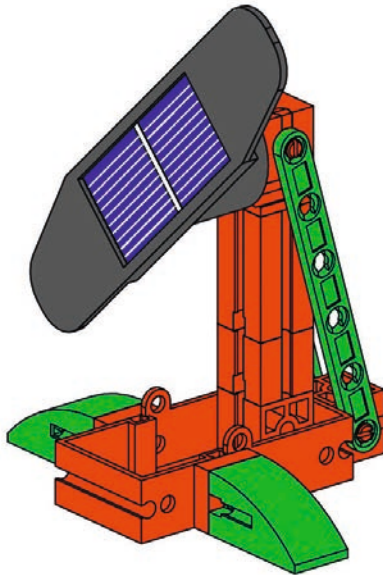
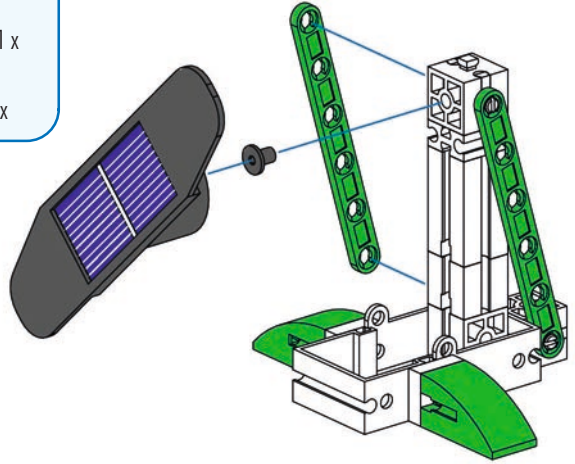
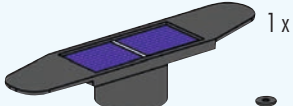

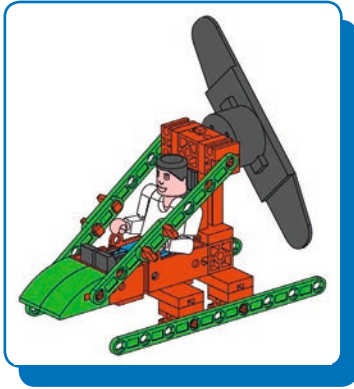
3



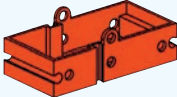



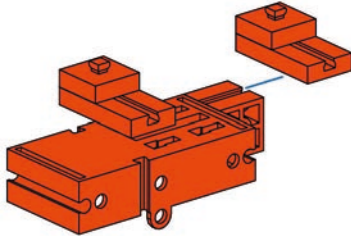

1

1x  1x 

2x  2x 



2

1x  2x  2x  2x 

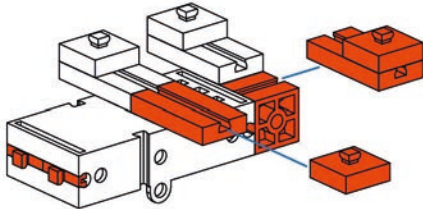

3

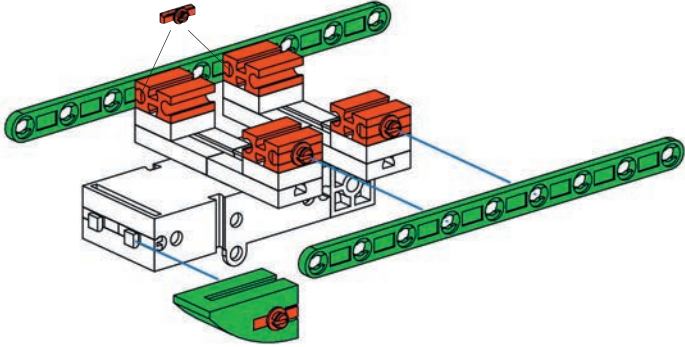
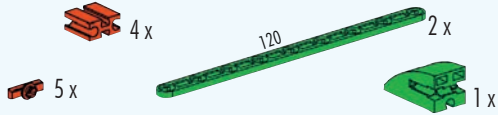

4

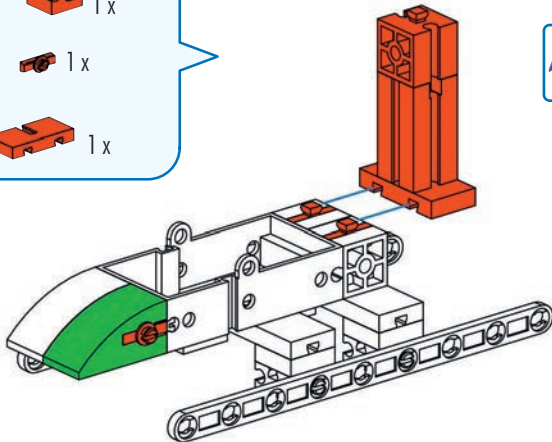
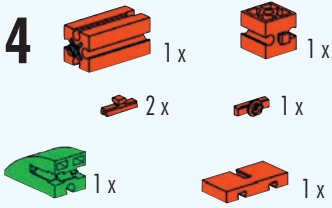

5

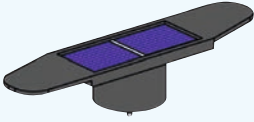

1 x



2 x

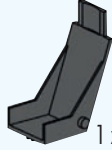

1 x



1 x



2 x

4



4 x



2 x

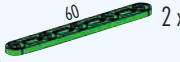

2 x

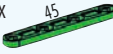



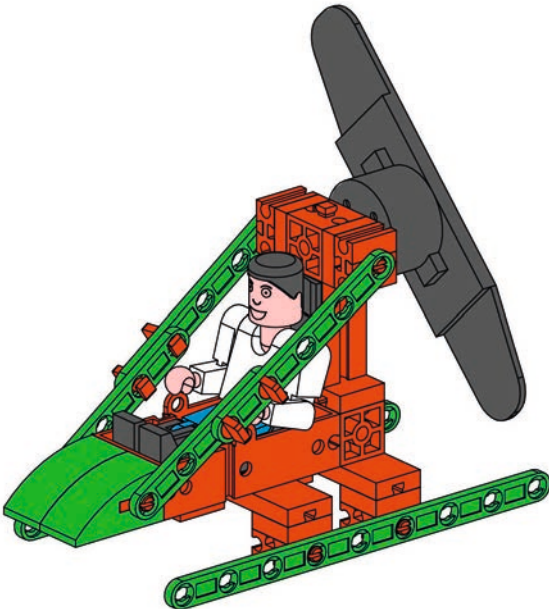
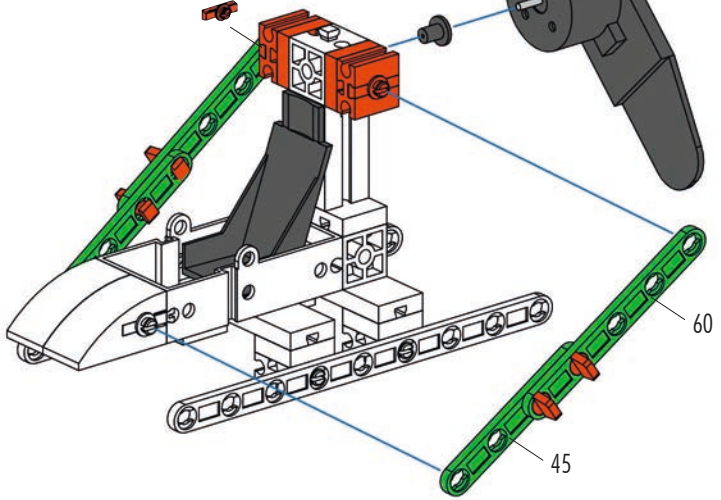
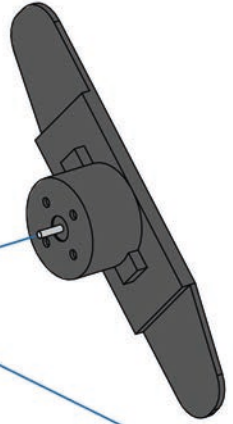

2 x



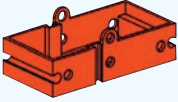



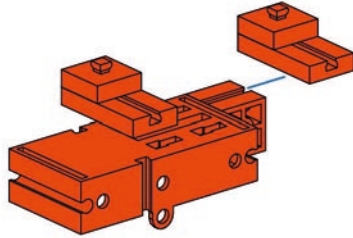

1

1x  1x 

2x  2x 



2

1x  2x  4x 

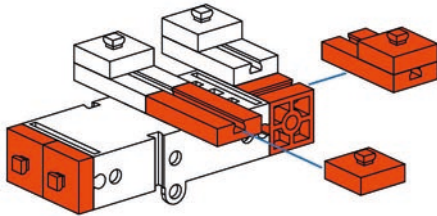



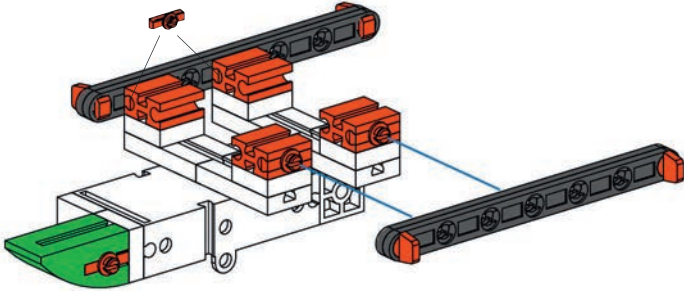

3

- 5 x 
- 4 x 
- 90 
- 4 x 
- 4 x 
- 1 x 



4

- 1 x 
- 1 x 
- 2 x 
- 1 x 
- 3 x 

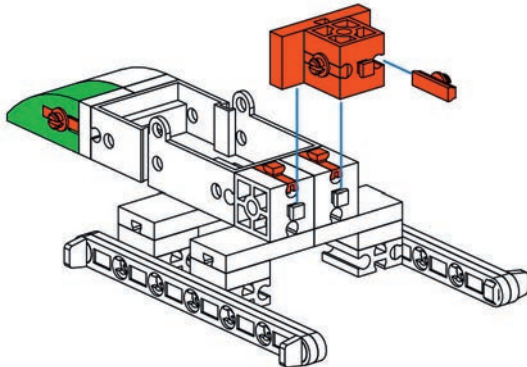

5

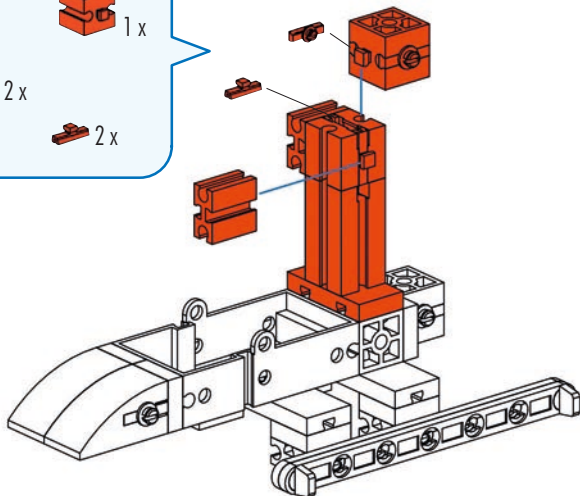
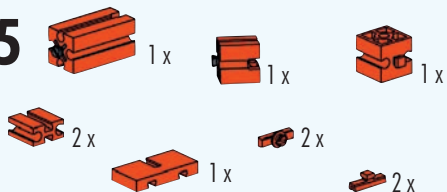

6

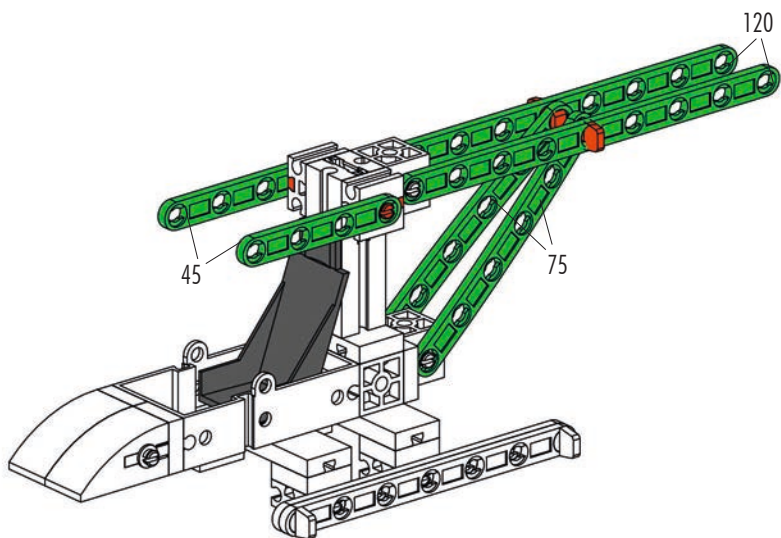
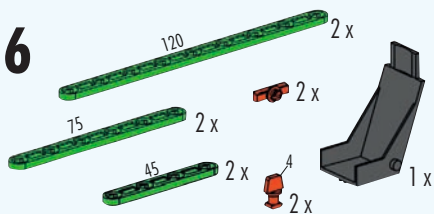

7

60 2 x 45 2 x 4 4 x

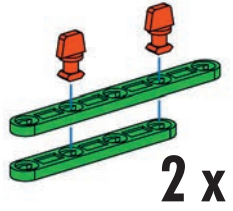

8

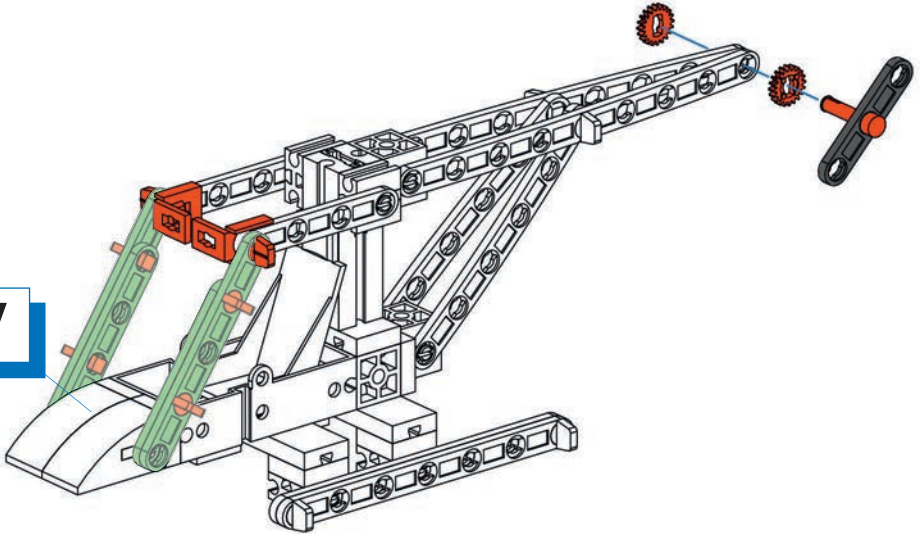

30 1 x 2 x 6 2 x 2 x 1 x

7

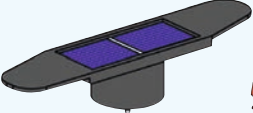

6 ≠ 4

9

- 1 x 
- 1 x 
- 1 x 
- 2 x 

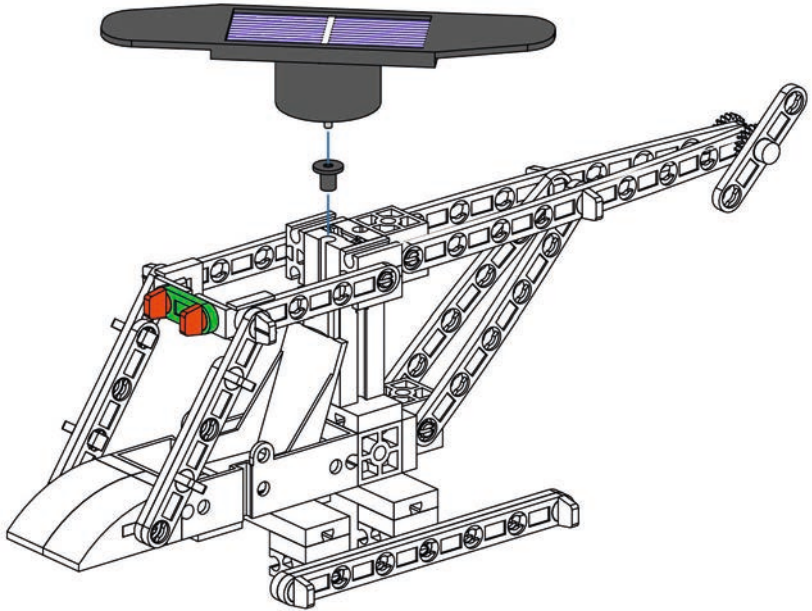

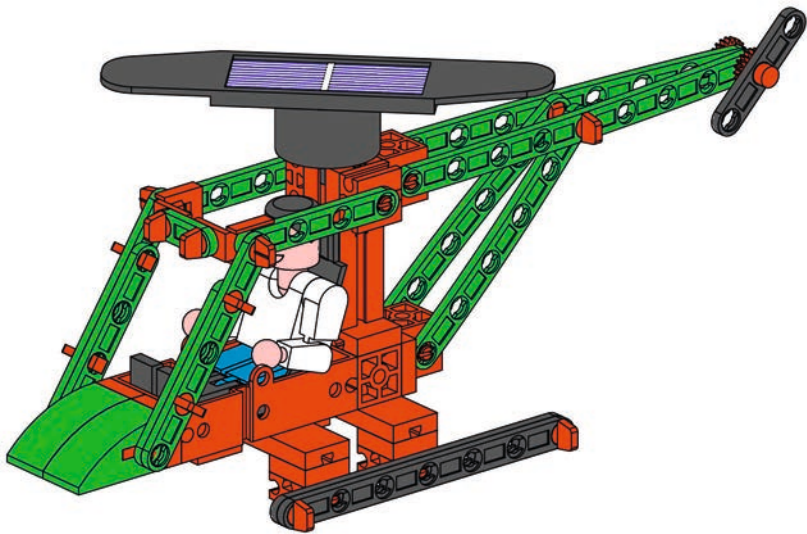

fischertechnik GmbH
Klaus-Fischer-Str. 1
72178 Waldachtal
Germany

Phone +49 74 43/12-43 69
Fax +49 74 43/12-45 91
info@fischertechnik.de
www.fischertechnik.de



fischertechnik 

ADVANCED

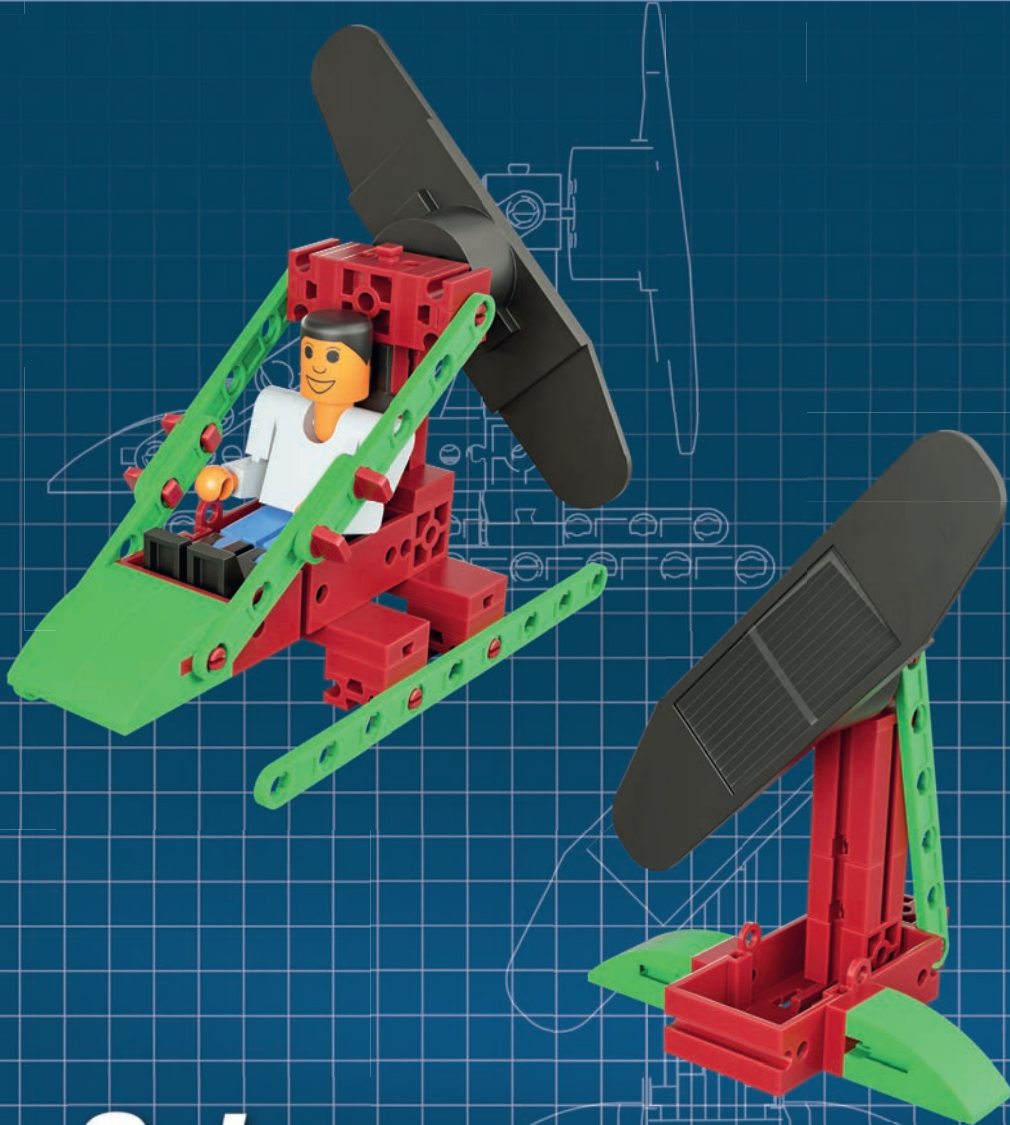

Solar

3 MODELS