

fischertechnik

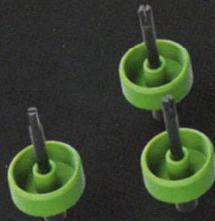

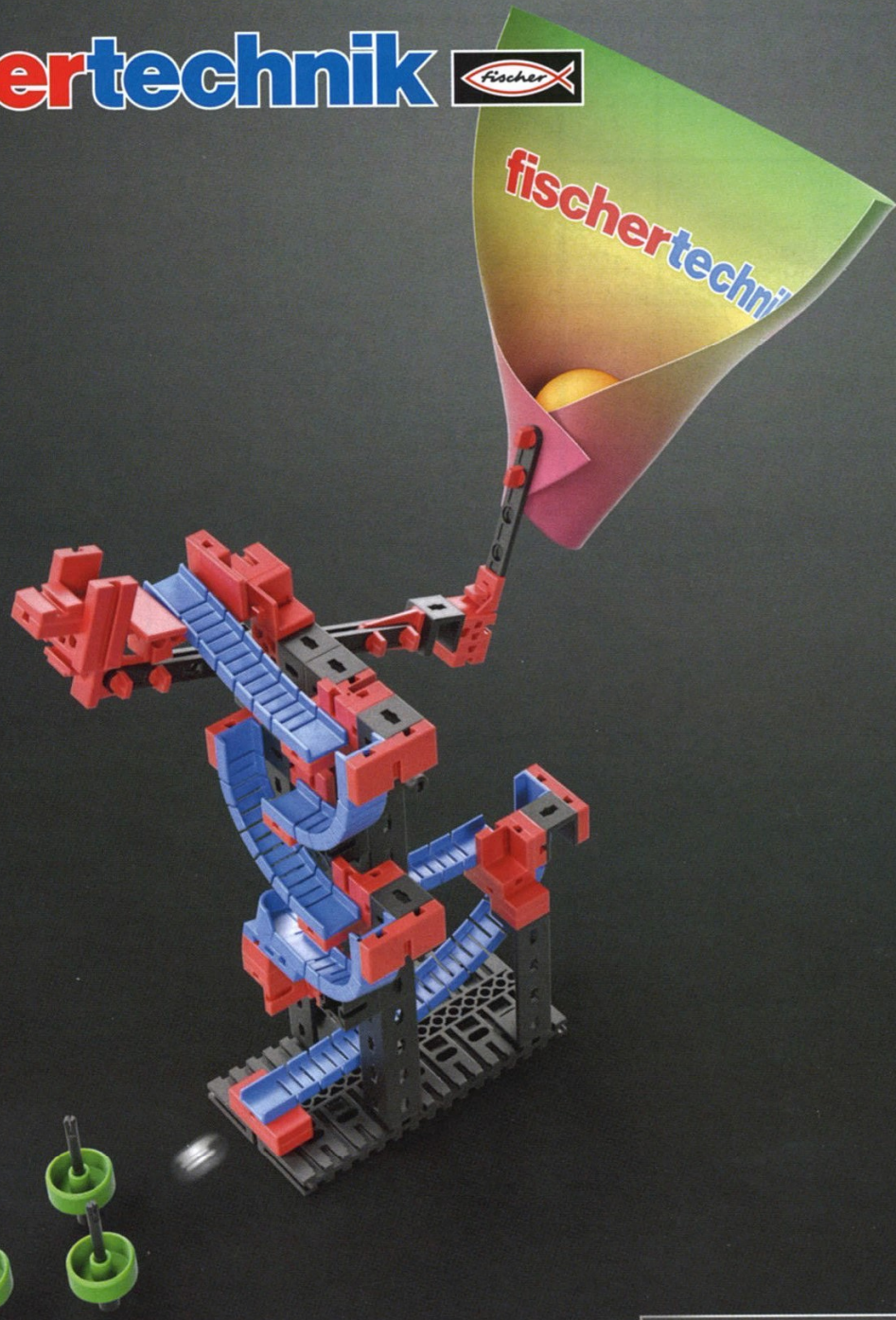























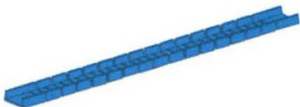







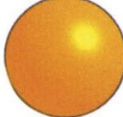

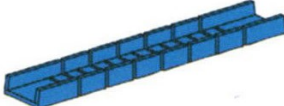

Bauanleitung
Assembly instruction
Instructions de montage
Bouwhandleiding
Instrucciones de construcción

Manual de montagem
Istruzioni di montaggio
Инструкция по сборке
安装说明书

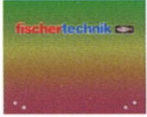

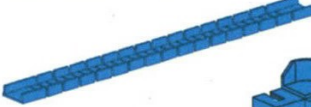
+ GAME
INSTRUCTIONS

ADVANCED Ping Pong Bowling

	31597 2 x		36 323 3 x		38 260 2 x
	31 674 1 x		36 324 4 x		38 423 2 x
	31 981 2 x		36 334 2 x		38 428 6 x
	31 982 2 x		36 921 3 x		38 546 2 x
	32 064 1 x		36 922 2 x		121 641 1 x
	32 071 2 x		36 950 5 x		144 262 1 x
	32 850 4 x		36 952 1 x		154 452 3 x
	35 049 8 x		37 237 10 x		154 485 1 x
	35 064 3 x		37 238 5 x		161 690 1 x
	35 066 1 x		37 468 5 x		161 691 5 x
	35 073 5 x		37 679 1 x		199 881 1 x
	35 129 1 x		38 240 12 x	  Erfinder Flexprofil 121 641 + 90° Kurve 161 690 Design und Konzeption Andreas Lehrberger	
	36 293 2 x		38 241 2 x		

- Alle Einzelteile, insbesondere bewegliche Teile sind falls notwendig zu warten und zu reinigen.
- All components, especially moving parts, should be maintained and cleaned as necessary.
- Toutes les pièces détachées et en particulier les pièces mobiles, sont, si nécessaire, à entretenir et à nettoyer.
- Alle onderdelen, vooral de bewegende delen, kunnen, indien noodzakelijk, onderhouden en gereinigd worden.
- Es necesario mantener limpio y en buen estado cada una de las piezas. Particularmente las piezas móviles.
- Todas as peças individuais, especialmente peças móveis, devem ser submetidas à manutenção e limpas se necessário.
- Se necessario, tutti i singoli componenti, soprattutto le parti mobili, si devono eventualmente sottoporre a manutenzione e pulizia.
- Все детали, особенно подвижные, требуют ухода и чистки.
- 必要时应保养和清洁所有零件，尤指运动部件。

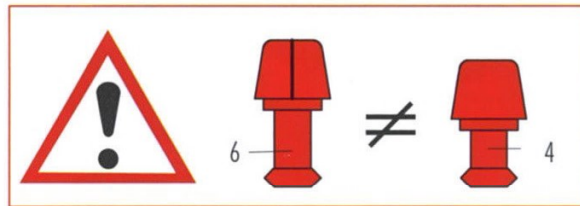
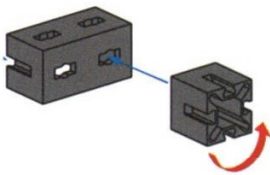

www.fischertechnik.de/FanClub

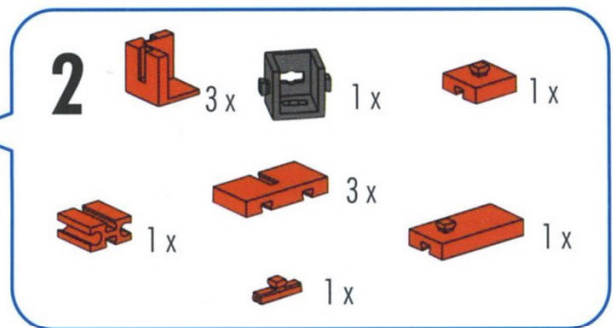
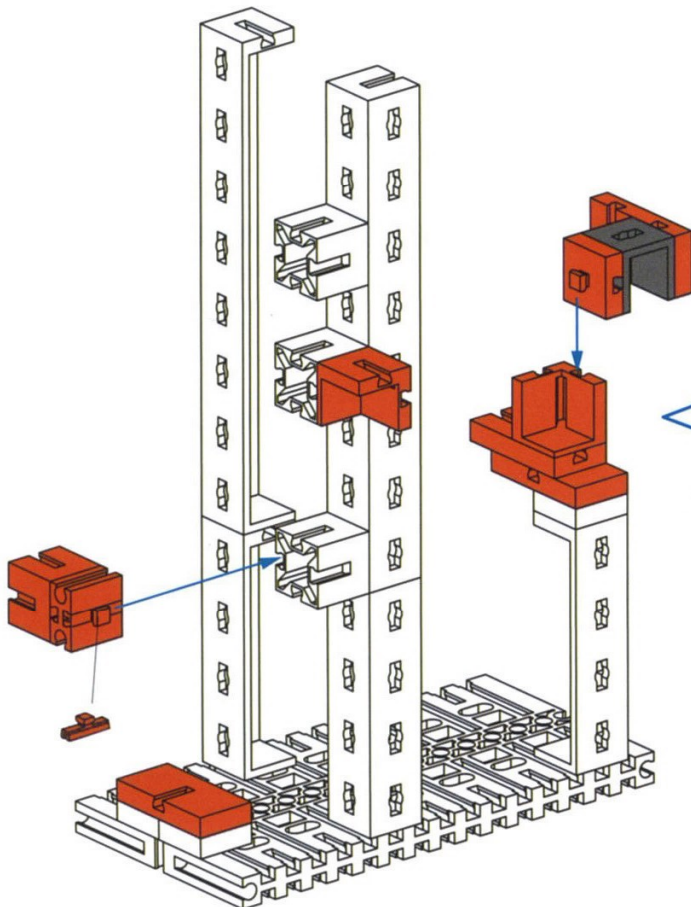
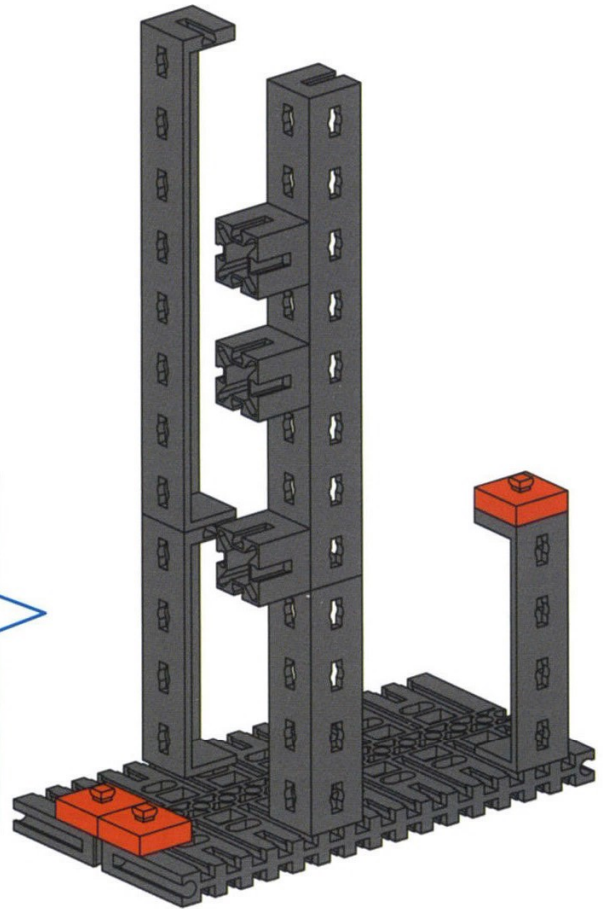
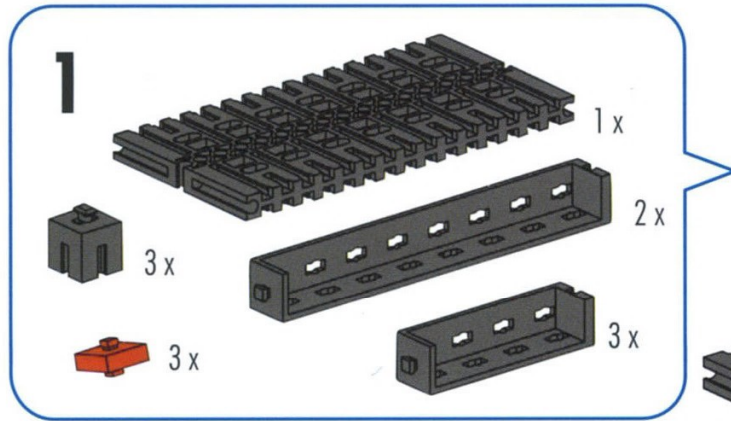
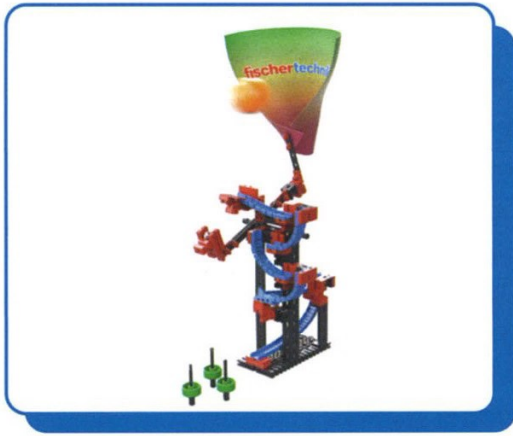

3

- 1x Blue Technic Beam 11
- 1x Red Technic Pin
- 2x Red Technic L-Shape
- 1x Blue Technic L-Shape
- 1x Red Technic Pin (15°)
- 1x Red Technic Pin
- 1x Red Technic Pin

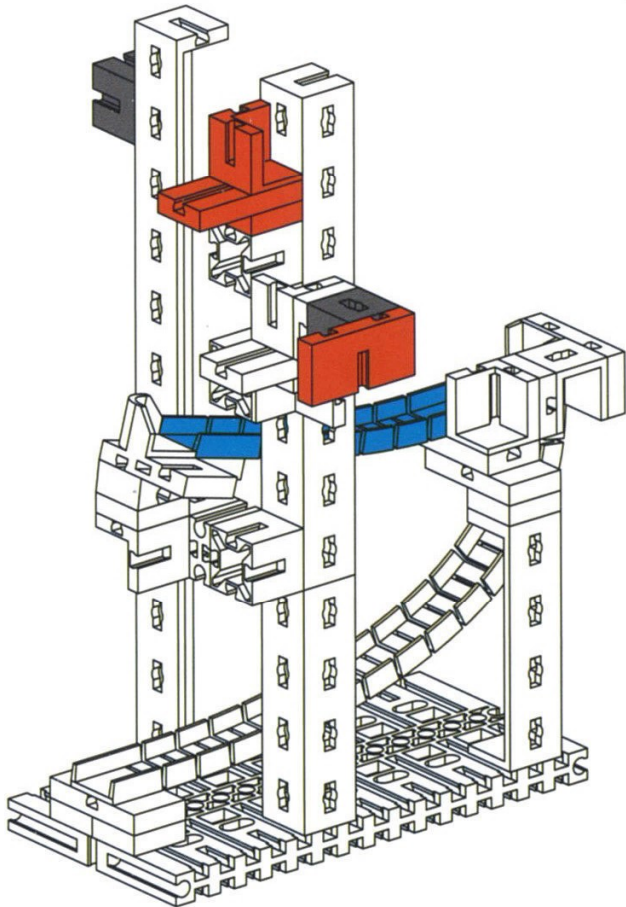
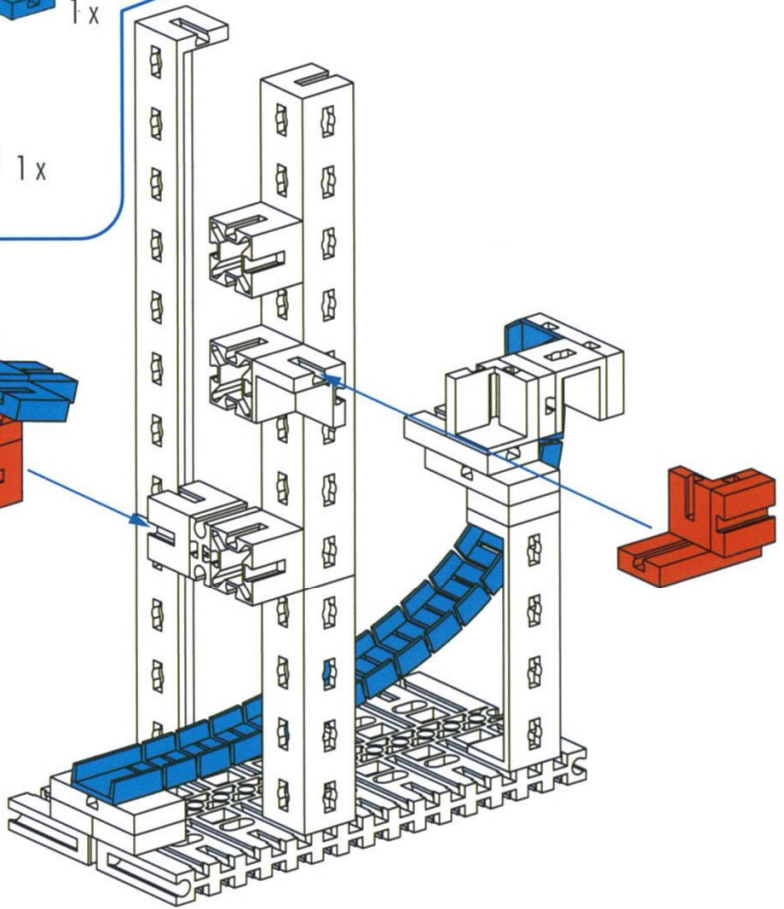
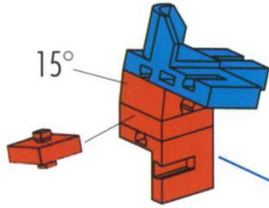
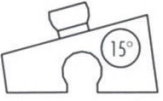

4

- 1x Red Technic L-Shape
- 1x Black Technic L-Shape
- 1x Red Technic Pin
- 1x Red Technic Pin
- 1x Red Technic Pin
- 1x Black Technic L-Shape
- 1x Blue Technic Beam 11

5

- 1x Blue Technic Beam (1x5)
- 1x Red Technic L-Bracket
- 1x Red Technic 1x2 Pin
- 2x Red Technic 1x2 Pin
- 1x Red Technic 1x2 Pin
- 1x Black Technic 1x2 Pin
- 1x Red Technic 1x2 Pin

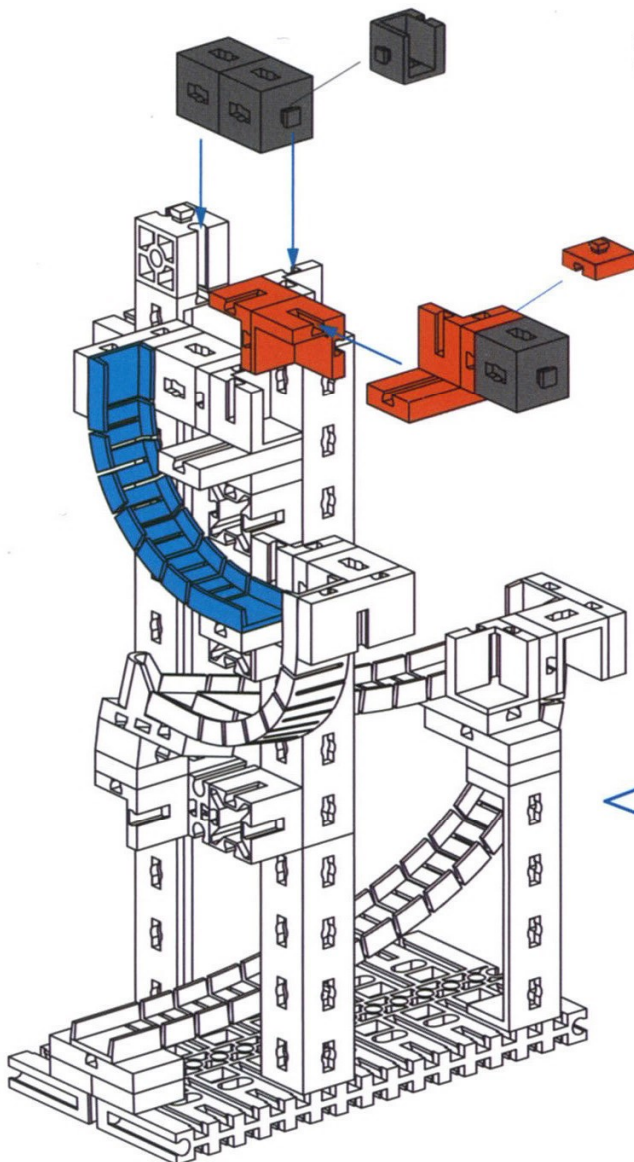
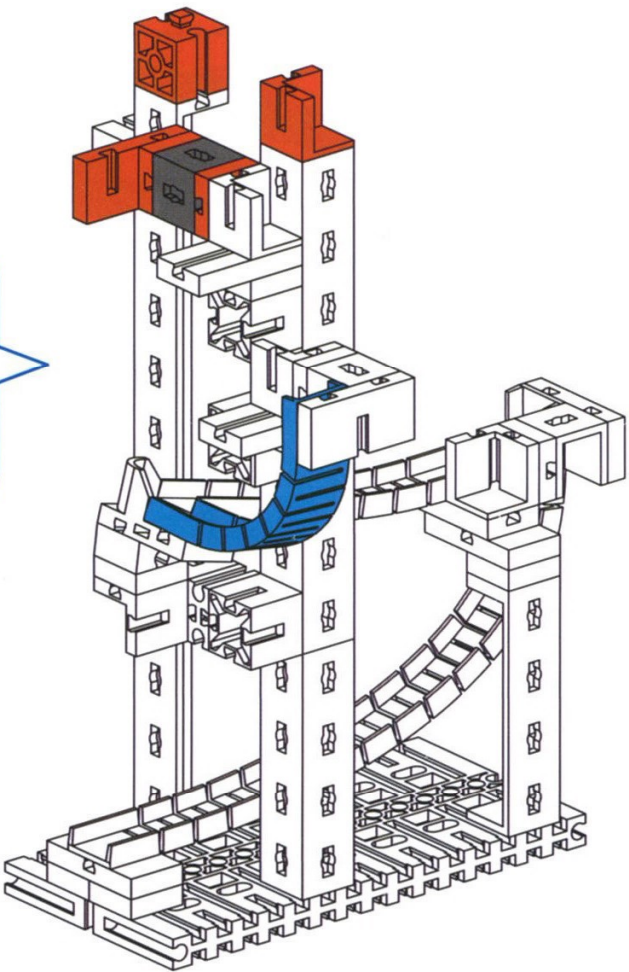

6

- 3x Red Technic L-Bracket
- 2x Black Technic 1x2 Pin
- 1x Black Technic 1x2 Pin
- 1x Red Technic 1x2 Pin
- 1x Red Technic 1x2 Pin
- 1x Blue Technic Beam (1x5)

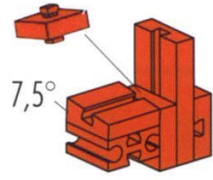

7

- 1x Blue Technic Beam (11 holes)
- 1x Red Technic Beam (11 holes)
- 2x Red Technic L-shaped Connector
- 1x Red Technic 1x2 Connector
- 1x Red Technic 1x3 Connector
- 1x Red Technic 1x4 Connector
- 1x Red Technic 1x5 Connector
- 1x Red Technic 1x6 Connector
- 1x Red Technic 1x7 Connector
- 1x Red Technic 1x8 Connector
- 1x Red Technic 1x9 Connector
- 1x Red Technic 1x10 Connector
- 1x Red Technic 1x11 Connector

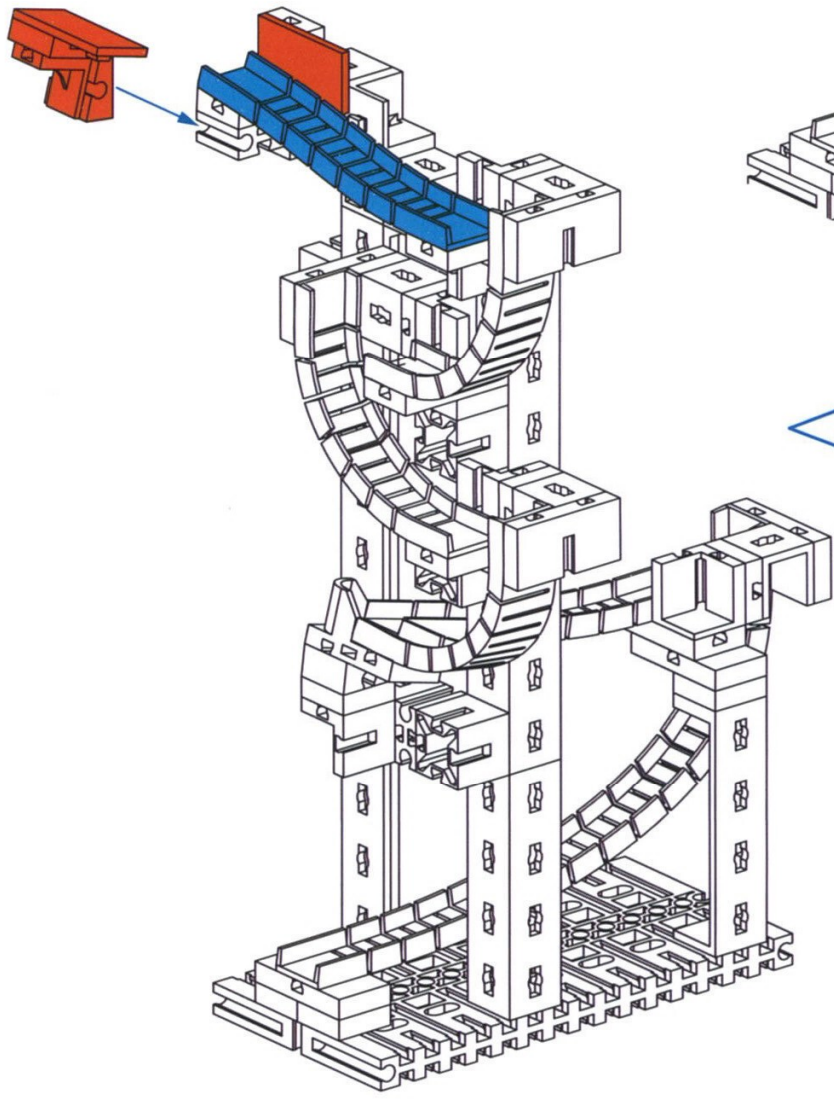
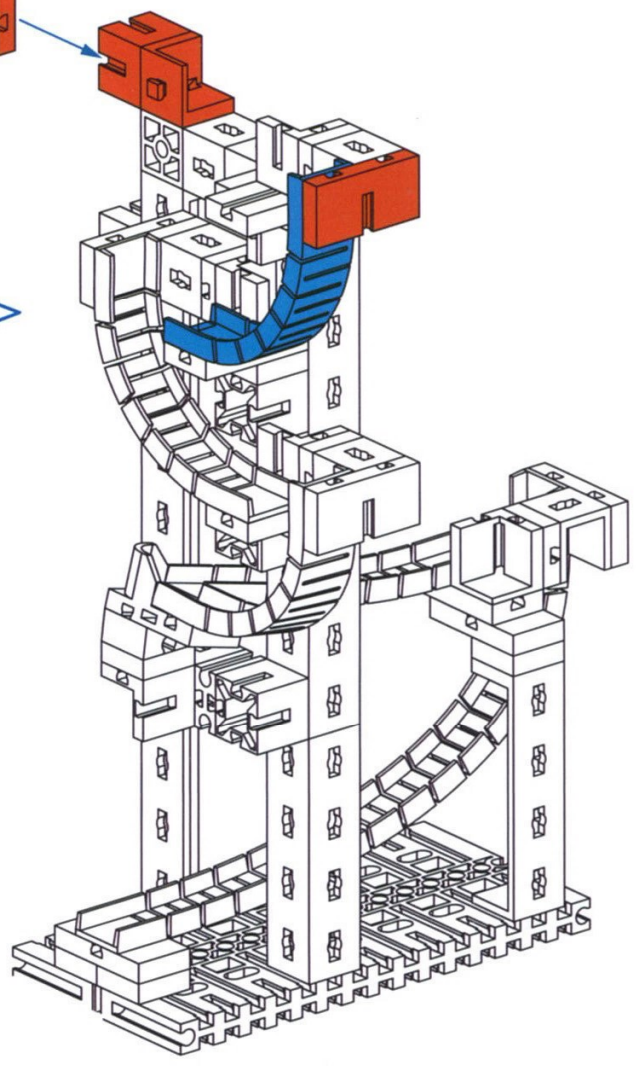
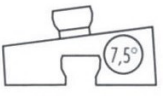

8

- 1x Blue Technic Beam (11 holes)
- 2x Red Technic Beam (11 holes)
- 1x Red Technic 1x2 Connector
- 1x Red Technic L-shaped Connector
- 1x Red Technic 15-degree Angled Connector

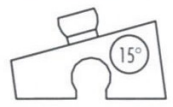

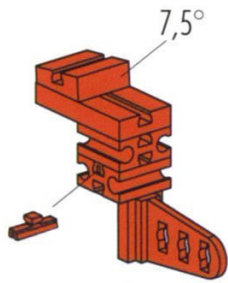

9

- 1 x (red 1-hole Technic axle)
- 2 x (red 1-hole Technic axle)
- 1 x (red 1-hole Technic axle)
- 1 x (red 1-hole Technic axle)
- 1 x (red 1-hole Technic axle)
- 1 x (red 1-hole Technic axle)

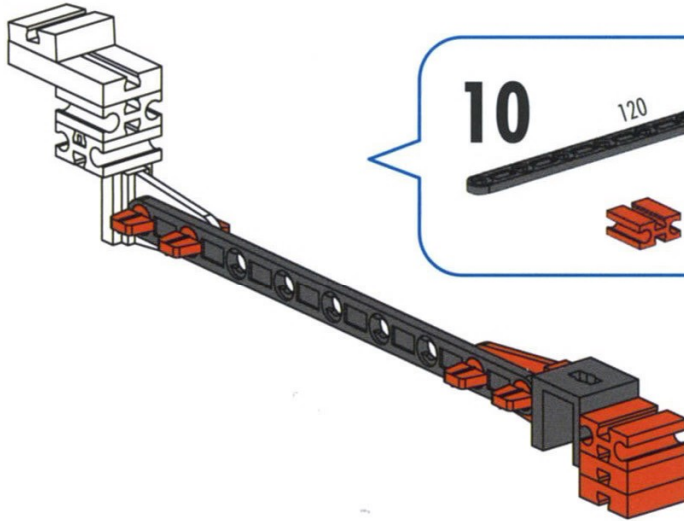

10

- 1 x (black 120-hole Technic axle)
- 1 x (red 1-hole Technic axle)
- 1 x (red 1-hole Technic axle)
- 4 x (red 1-hole Technic axle)
- 2 x (red 1-hole Technic axle)
- 1 x (red 1-hole Technic axle)
- 1 x (grey 1-hole Technic axle)

11

- 1 x (black 60-hole Technic axle)
- 2 x (red 1-hole Technic axle)
- 1 x (black 120-hole Technic axle)
- 1 x (black 90-hole Technic axle)
- 1 x (red 1-hole Technic axle)
- 1 x (red 1-hole Technic axle)
- 1 x (red 1-hole Technic axle)
- 1 x (red 1-hole Technic axle)
- 1 x (black 1-hole Technic axle)

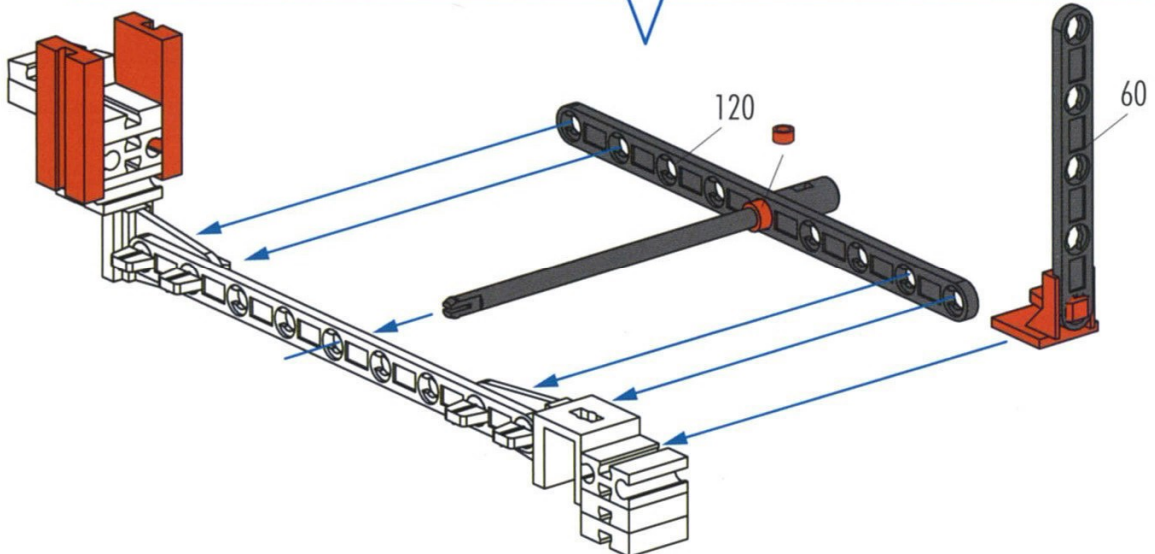

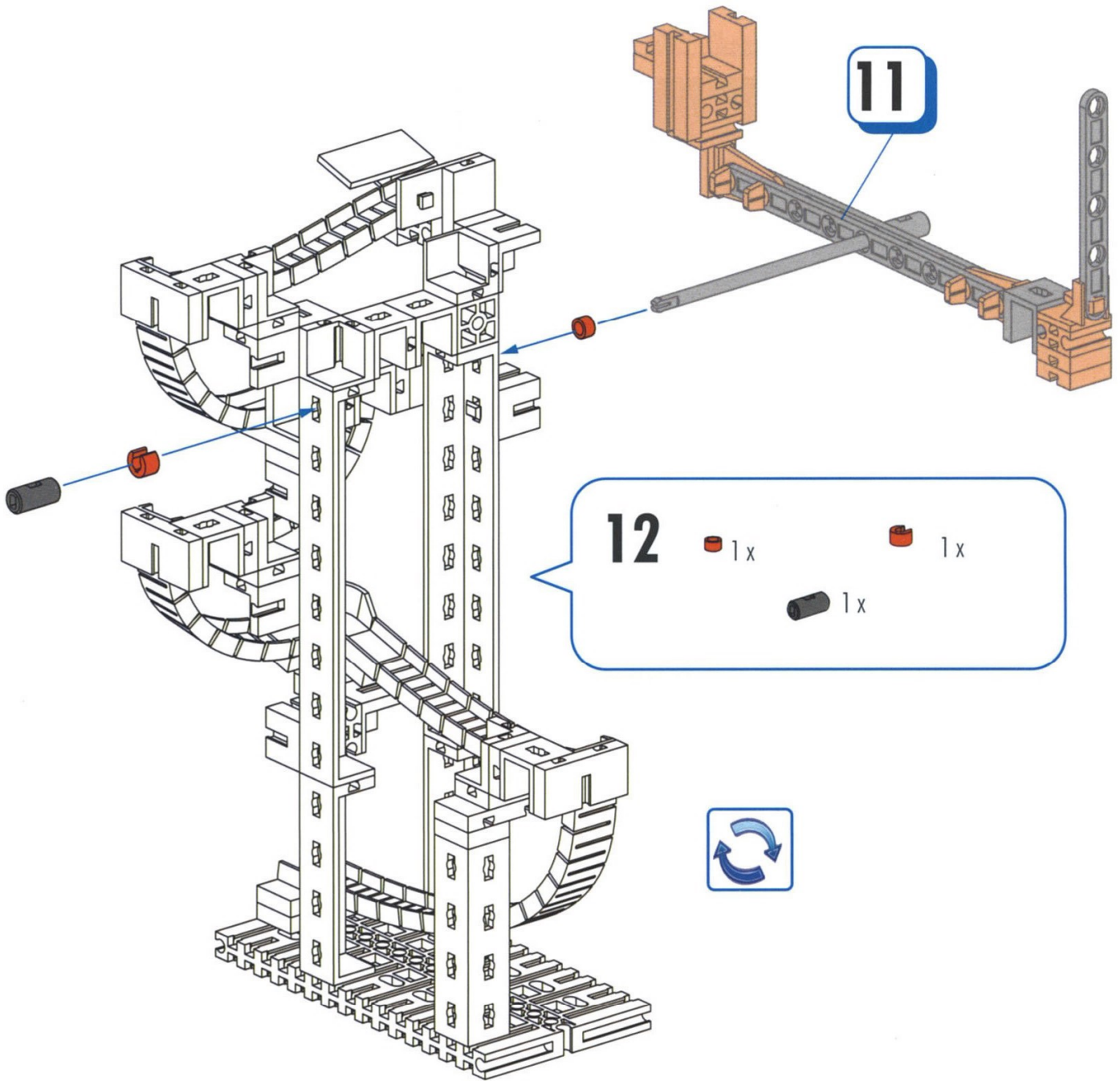

13 45 3x 3x 3x

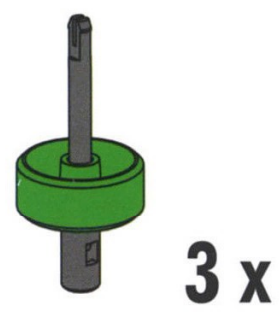

14

fischertechnik 

 2 x

 2 x

 1 x

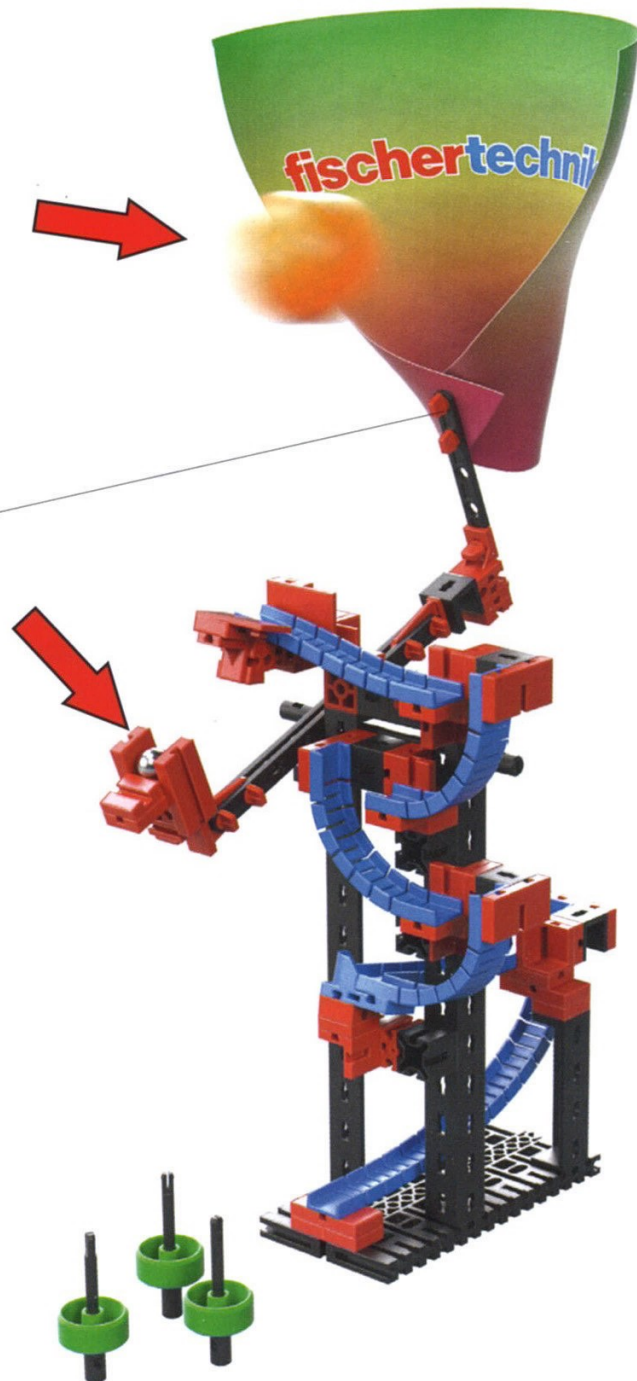

D Spielanleitung

Nachdem du das Modell aufgebaut hast, kann es schon losgehen.

Ziel des Spiels:

Bei diesem Spiel geht es darum, alle Kegel mit der Metallkugel umzuwerfen.

Der perfekte Wurf

Baue die drei Kegel neben dem Spielfeld auf, wie es auf der Abbildung gezeigt wird. Lege dann die Metallkugel in die Wippe.

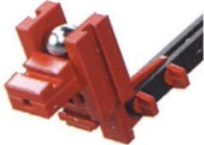

Nimm jetzt den Tischtennisball und stelle dich etwa einen Meter vom Spielfeld entfernt auf. Du solltest so stehen, dass der offene Trichter in deine Richtung zeigt.



Ziele mit dem Tischtennisball auf den Trichter und wirf ihn dann in den Trichter. Der Tischtennisball löst die Wippe aus. Die Metallkugel wird auf die Bahn gesetzt und rollt los. Unten angekommen rollt sie auf die Kegel zu. Trifft sie alle Kegel?

USA+GB Game Instructions

Once you have set up the model, you are good to go.

Aim of the game:

The aim of this game is to knock down all the skittles using the metal ball.

The perfect throw

Set the three skittles up next to the board as shown in the picture. Then place the metal ball in the propeller



Now take the ping pong ball and stand approximately one metre away from the board. You should stand so that the open funnel is pointing in your direction.



Aim the ping pong ball at the funnel and then throw it into the funnel. The ping pong ball triggers the propeller. The metal ball is placed on the track and rolls off. Once at the bottom, it rolls towards the skittles. Does it hit all the skittles?

F

NL

E

P

I

RU

CN



<https://www.fischertechnik.de/ping-pong-bowling>

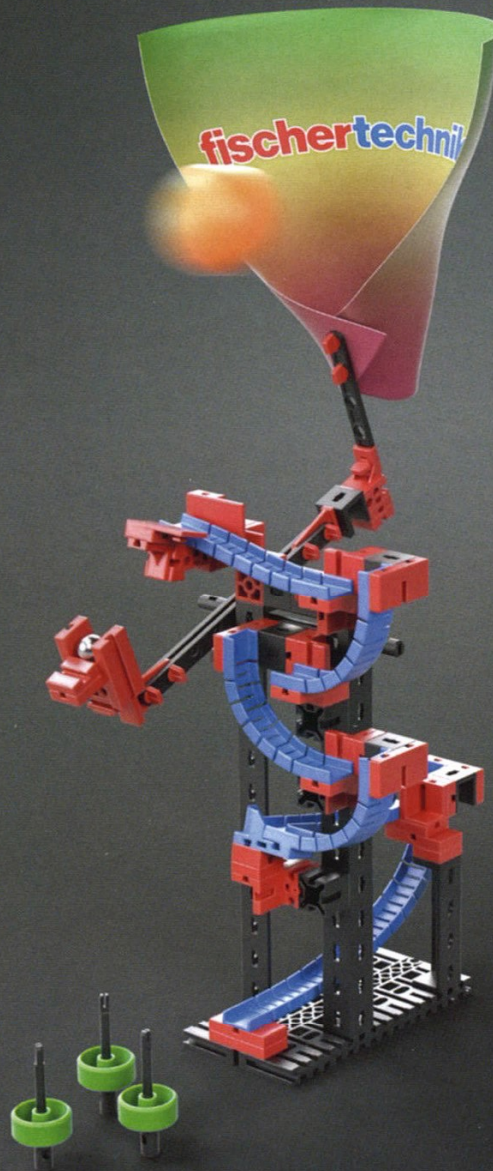

ADVANCED Ping Pong Bowling

fischertechnik GmbH

Klaus-Fischer-Str. 1
72178 Waldachtal
Germany

Phone: +49 74 43/12-43 69
Fax: +49 74 43/12-45 91

info@fischertechnik.de
www.fischertechnik.de

www.fischertechnik.de