



199560 - 06/23 - Co - Printed in Germany - Technische Änderungen vorbehalten - Subject to technical modifications



# ADVANCED Crazy Reactions

**fischertechnik GmbH**  
Klaus-Fischer-Str. 1  
72178 Waldachtal  
Germany

Phone: +4974 43/12-43 69  
Fax: +4974 43/12-45 91

info@fischertechnik.de  
www.fischertechnik.de

[www.fischertechnik.de](http://www.fischertechnik.de)



CHAIN REACTION

WASSERTANK /  
WATER TANK

0,5L PET  
NICHT ENTHALTEN /  
NOT INCLUDED

Bauanleitung  
Assembly instruction  
Instructions de montage  
Bouwhandleiding  
Instrucciones de construcción

Manual de montagem  
Istruzioni di montaggio  
Инструкция по сборке  
安装说明书

# ADVANCED Crazy Reactions

MODELS

**3**





- Tipps und Tricks zur Inbetriebnahme der Modelle
  - Tips and tricks for commissioning the models
  - Conseils et astuces pour la mise en service des modèles
  - Tips en trucs voor het in opdracht geven van de modellen
  - Consejos y trucos para encargar las maquetas
  - Dicas e truques para o comissionamento dos modelos
  - Consigli e suggerimenti per la messa in servizio dei modelli
  - Советы и рекомендации по вводу моделей в эксплуатацию
  - 调调试模型的技巧+诀窍
- Kombiniere deine Modelle
  - Combine your models
  - Combine tes modèles
  - Combineer je modellen
  - Combine sus modelos
  - Combine seus modelos
  - Combinare i modelli
  - Объедините свои модели
  - 结合你的模型



<https://www.fischertechnik.de/crazyreactions-tutorials>



- Werde Mitglied im kostenlosen fischertechnik Fan Club und nutze die Vorteile. Melde dich hierzu einfach unter [www.fischertechnik.de/FanClub](http://www.fischertechnik.de/FanClub) an.
- Become a member of the free fischertechnik fan club and take advantage of the benefits. Simply register at [www.fischertechnik.de/FanClub](http://www.fischertechnik.de/FanClub)
- Deviens membre du Fan club fischertechnik gratuit et profite de nombreux avantages. Il suffit de t'inscrire sur [www.fischertechnik.de/FanClub](http://www.fischertechnik.de/FanClub).
- Word lid van de gratis fischertechnik Fan Club en maak gebruik van de voordelen. Meldt u hiervoor aan op [www.fischertechnik.de/FanClub](http://www.fischertechnik.de/FanClub).
- Hazte miembro del club de aficionados gratuito de fischertechnik y disfruta de todas las ventajas. Regístrate en [www.fischertechnik.de/FanClub](http://www.fischertechnik.de/FanClub).
- Torne-se um membro do fã-clube gratuito da Fischertechnike aproveite-a. Basta registrar-se em [www.fischertechnik.de/FanClub](http://www.fischertechnik.de/FanClub).
- Diventa membro del fan club gratuito di fischertechnik e sfrutta tutti i vantaggi. Basta registrarsi a [www.fischertechnik.de/FanClub](http://www.fischertechnik.de/FanClub).
- Стань членом бесплатного фан-клуба fischertechnik и пользуйся преимуществами. Для этого просто зарегистрируйся по адресу [www.fischertechnik.de/FanClub](http://www.fischertechnik.de/FanClub).
- x免费加入慧鱼粉丝俱乐部 (fischertechnik Fan Club) 会员，即刻享受会员福利。只需前往 [www.fischertechnik.de/FanClub](http://www.fischertechnik.de/FanClub) 完成注册即可。



**Inhalt**  
**Contents**  
**Contenu**

**Inhoud**  
**Contenido**  
**Conteúdo**

**Contenuto**  
**Содержание**  
**目录**

Einzelteilübersicht / Spare parts list / Liste des pièces détachées / Onderdelenoverzicht / Lista da piezas / Resumo de peça individual /  
Singoli componenti / Перечень деталей / 零件概览 ..... 2

Montagetipps / Tips for assembly / Tuyaux pour le montage / Montagetips / Consejos para el montaje / "Dicas" para montagem /  
Consigli per il montaggio / Советы по сборке / 装配建议 ..... 4



Parcours 1 / Obstacle course 1 / Parcours 1 / Parcours 1 /  
Pista de recorrido 1 / Circuito 1 / Circuito 1 / Маршрут 1 /  
滚珠弯道 1 ..... 6

Parcours 2 / Obstacle course 2 / Parcours 2 / Parcours 2 /  
Pista de recorrido 2 / Circuito 2 / Circuito 2 / Маршрут 2 /  
滚珠弯道 2 ..... 32



Parcours 3 / Obstacle course 3 / Parcours 3 / Parcours 3 /  
Pista de recorrido 3 / Circuito 3 / Circuito 3 / Маршрут 3 /  
滚珠弯道 3 ..... 54





**Einzelteilübersicht**  
**Spare parts list**  
**Liste des pièces détachées**

	19 316 1 x
	31 010 7 x
	31 011 6 x
	31 016 2 x
	31 020 2 x
	31 060 5 x
	31 124 2 x
	31 330 2 x
	31 426 12 x
	31 436 12 x
	31 597 6 x
	31 642 3 x
	31 667 2 x
	31 668 1 x
	31 670 4 x
	31 674 13 x
	31 690 3 x

**Onderdelenoverzicht**  
**Lista da piezas**  
**Resumo de peça individual**

	31 760 1 x
	31 891 1 x
	31 896 1 x
	31 981 9 x
	31 982 18 x
	31 983 3 x
	32 064 14 x
	32 071 9 x
	32 321 2 x
	32 330 1 x
	32 850 6 x
	32 870 1 x
	32 913 1 x
	32 974 1 x
	32 985 3 x
	35 039 1 x
	35 049 3 x

**Singoli componenti**  
**Перечень деталей**  
**零件概览**

	35 053 3 x
	35 057 1 x
	35 063 2 x
	35 064 1 x
	35 065 1 x
	35 066 1 x
	35 073 6 x
	35 087 1 x
	35 088 2 x
	35 945 2 x
	35 975 1 x
	36 293 12 x
	36 294 2 x
	36 297 4 x
	36 299 7 x
	36 323 34 x
	36 334 1 x
	36 819 2 x
	36 905 1 x
	36 913 1 x
	36 920 7 x
	36 921 5 x
	36 922 5 x
	36 923 1 x
	36 938 1 x
	36 950 6 x
	36 970 1 x
	37 237 16 x
	37 238 3 x
	37 468 12 x
	37 636 5 x
	37 679 5 x
	38 240 28 x
	38 241 2 x



**Einzelteilübersicht**  
**Spare parts list**  
**Liste des pièces détachées**

	38 242 1 x
	38 246 13 x
	38 248 1 x
	38 253 1 x
	38 259 1 x
	38 423 10 x
	38 428 6 x
	38 531 1 x
	38 538 1 x
	38 540 1 x

**Onderdelenoverzicht**  
**Lista da piezas**  
**Resumo de peça individual**

	38 541 1 x
	38 543 2 x
	38 545 1 x
	38 546 2 x
	78 728 6 x
	116 251 1 x
	116 252 4 x
	127 471 6 x
	127 472 3 x
	130 593 1 x

	132 223 2 x
	136 529 1 x
	137 677 1 x
	139 648 1 x
	143 235 1 x
	146 529 1 x
	146 531 2 x
	154 485 1 x
	156 107 1 x
	159 590 1 x

**Singoli componenti**  
**Перечень деталей**  
**零件概覽**

	159 781 4 x
	163 202 1 x
	173 041 1 x
	175 045 2 x
	190 637 1 x
	190 638 2 x
	193 428 1 x
	193 429 1 x
	199 882 1 x

**Sicherheitshinweise**  
**Safety Information**  
**Consignes de sécurité**

- Alle Einzelteile, insbesondere bewegliche Teile sind falls notwendig zu warten und zu reinigen.
- All components, especially moving parts, should be maintained and cleaned as necessary.
- Toutes les pièces détachées et en particulier les pièces mobiles, sont, si nécessaire, à entretenir et à nettoyer.
- Alle onderdelen, vooral de bewegende delen, kunnen, indien noodzakelijk, onderhouden en gereinigd worden.
- Es necesario limpiar y mantener en buen estado todas las diferentes piezas - especialmente las piezas móviles.

**Veiligheidsrichtlijnen**  
**Indicaciones de seguridad**  
**Observações sobre segurança**

- Caso necessário, todas as peças individuais, especialmente peças móveis, tem que ser submetidas à manutenção e ser limpadas.
- Se necessario, tutti i singoli componenti, soprattutto le parti mobili, si devono eventualmente sottoporre a manutenzione e pulizia.
- Все детали, особенно подвижные, требуют ухода и чистки.
- 必要时应保养和清洁所有零件，尤指运动部件。

**Informazioni per la sicurezza**  
**Указания по технике безопасности**  
**安全指南**

- 
- Achtung: Erstickungsgefahr durch kleine Kugel und verschluckbare Kleinteile!
  - Warning: risk of suffocation due to small balls and parts that can be swallowed!
  - Attention : risque d'étouffement avec des petites billes et des petites pièces pouvant être avalées !
  - Waarschuwing: verstikkingsgevaar door kleine kogeltjes en inslikbare kleine delen!

- Advertencia: i riesgo de asfixia con las bolas y piezas pequeñas que pueden ingerirse!
- Advertência: perigo de asfixia devido a esferas pequenas e peças pequenas que podem ser engolidas!
- Avviso: pericolo di soffocamento a causa delle piccole sfere e dei piccoli pezzi ingoiabili!
- Внимание: Опасность удушения маленьким шариком и маленькими деталями!
- 警告：可能誤吞的小球和小零件有造成窒息的危險！



**Montagetipps**  
**Tips for assembly**  
**Tuyaux pour le montage**



**Montagetipps**  
**Consejos para el montaje**  
**"Dicas" para montagem**

**Consigli per il montaggio**  
**Советы по сборке**  
**装配建议**

Schlauchzuschnitte  
 Hose cut to length  
 Découpes de tuyau

Slangdelen  
 Recortes de tubos flexibles  
 Recortes de mangueira

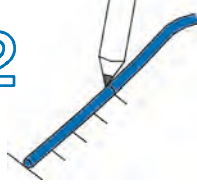
Spezzoni di tubo  
 Штуцеры  
 软管段

1  2  3 

2 x 4 cm  
 2 x 8 cm  
 1 x 20 cm  
 1 x 30 cm  
 1 x 45 cm

0,5L PET Flaschen, Kunststoffbecher und Papprolle nicht enthalten  
 0,5L PET bottles, plastic cups and cardboard roll not included  
 Bouteilles PET de 0,5L, gobelets en plastique et rouleau de carton non inclus  
 0,5L PET-flessen, plastic bekers en kartonnen rol niet inbegrepen  
 Botellas de PET de 0,5 l, vasos de plástico y rollo de cartón no incluidos  
 Garrafas PET de 0,5 L, copos de plástico e rolo de cartão não incluídos  
 Bottiglie PET da 0,5L, bicchieri di plastica e rotolo di cartone non inclusi  
 ПЭТ-бутылки 0,5 л, пластиковые стаканчики и картонный рулон в комплект не входят  
 不包括0.5L PET瓶、塑料杯和纸板卷

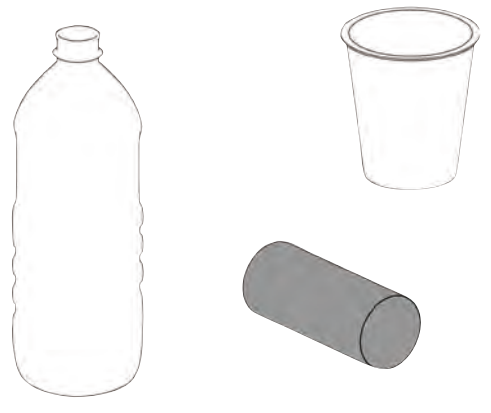

PET Flaschenhalter  
 1881 rot

PET Flaschenhalter  
 26/22 schwarz

Es gibt 2 verschiedene Gewinde! Bitte ausprobieren, welcher Flaschenhalter zu deiner 0,5 Liter PET Flasche passt.  
 There are 2 different threads! Please try out which bottle holder fits your 0.5 liter PET bottle.  
 Il y a 2 filetages différents ! Essaie pour savoir quel support de bouteille convient pour ta bouteille PET de 0,5 litre.  
 Er zijn 2 verschillende soorten schroefdraad. Gewoon uitproberen welke flessenhouder het beste bij jou fles PET van 0,5 liter past.  
 iHay 2 roscas diferentes! Pruebe cuál portabotellas es el adecuado para su botella PET de 0,5 litros.  
 Há 2 roscas diferentes! Por favor, experimente qual suporte de frascos se adapta ao seu frasco PET de 0,5 litros.  
 Ci sono due filetti diversi! Si prega di verificare quale portabottiglie è adatto alla vostra PET bottiglia PET da 0,5 litri.  
 Существуют две разные резьбы! Проверь, какой флягодержатель подходит к твоей поллитровой ПЭТ фляге.  
 有 2 种不同螺纹! 请尝试哪种瓶架适用您的 0.5 升PET瓶子。



**Montagetipps**  
**Tips for assembly**  
**Tuyaux pour le montage**

**Montagetips**  
**Consejos para el montaje**  
**"Dicas" para montagem**

**Consigli per il montaggio**  
**Советы по сборке**  
**装配建议**

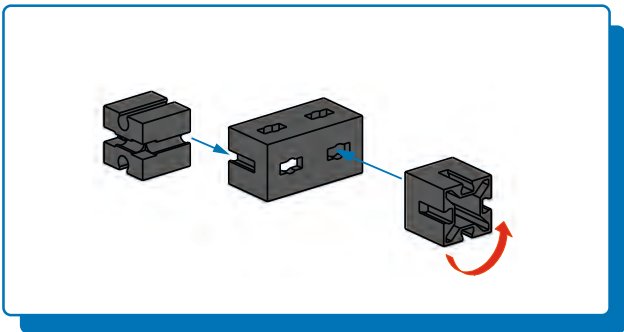
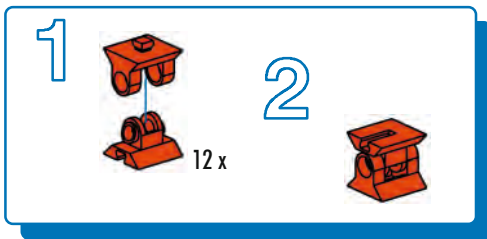
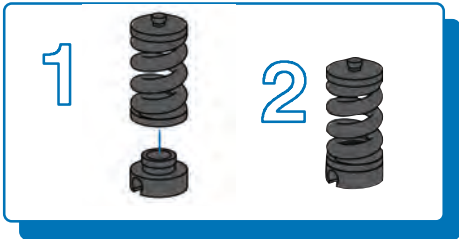
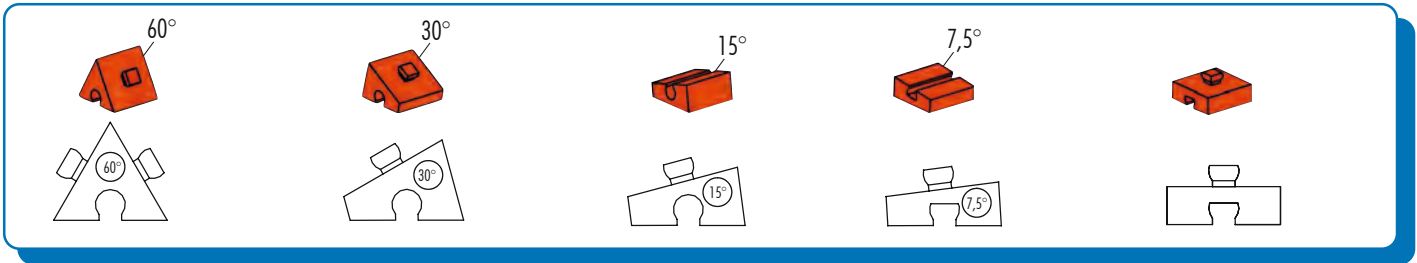
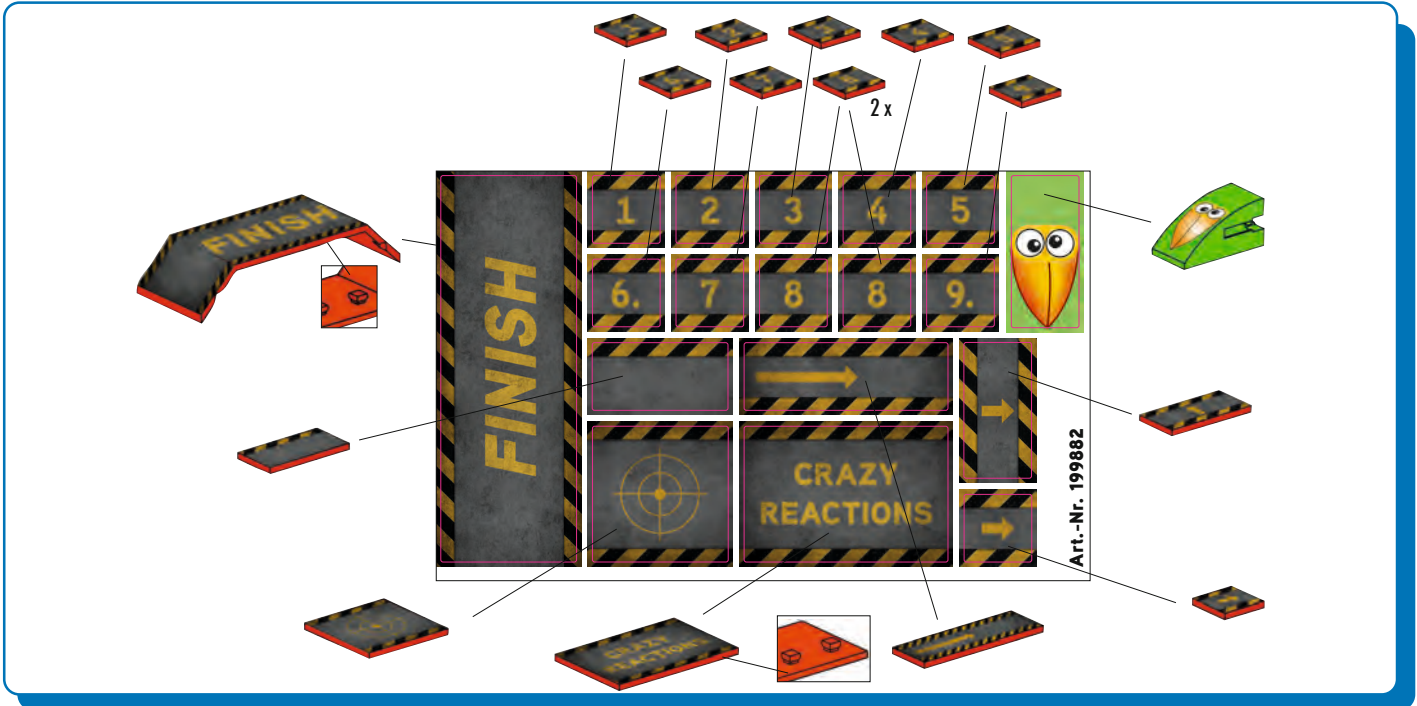





Parcours 1  
Obstacle course 1  
Parcours 1

Parcours 1  
Pista de recorrido 1  
Circuito 1

Circuito 1  
Маршрут 1  
滚珠弯道 1

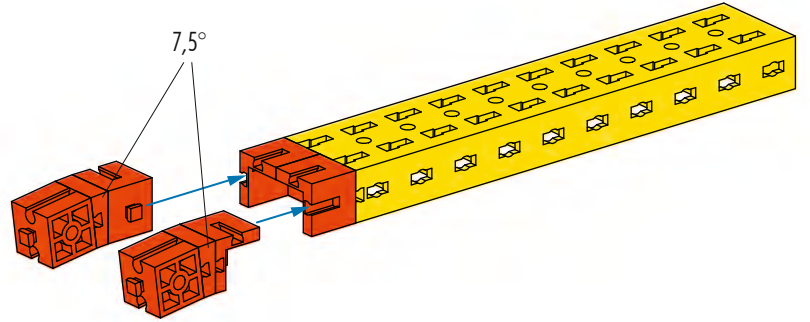
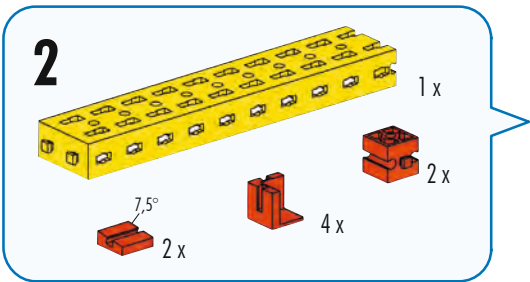
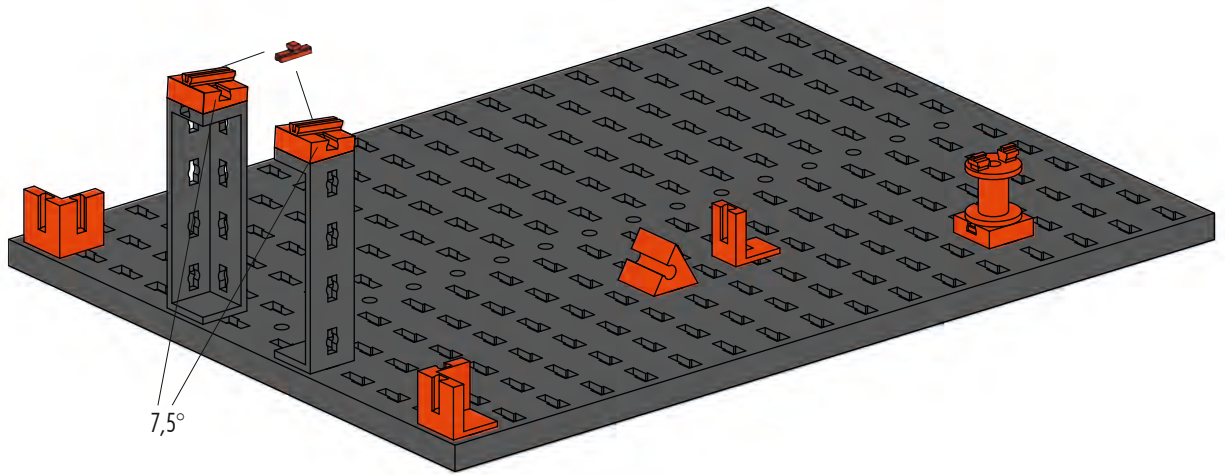
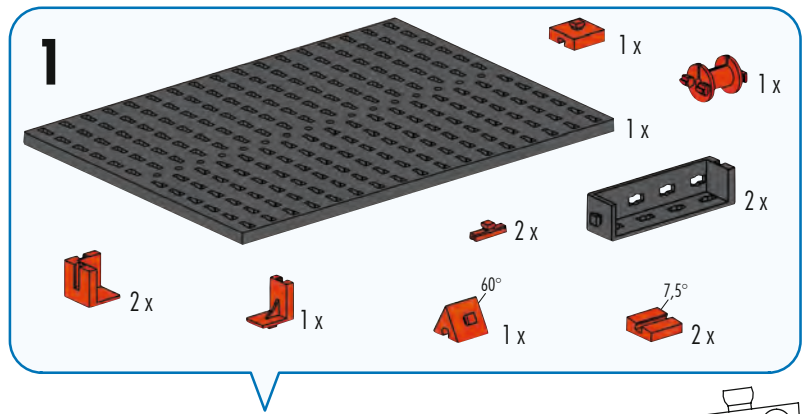



3

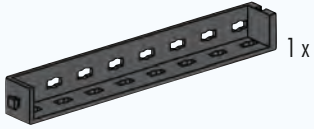

1x



1x



1x



1x

2

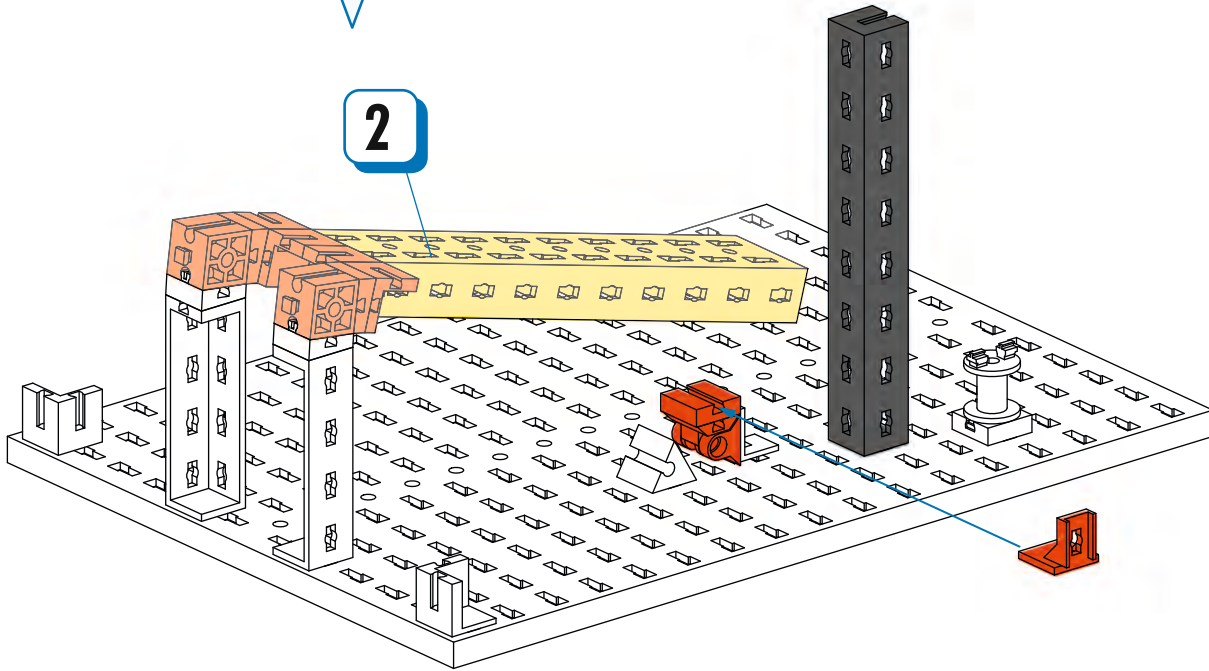

4

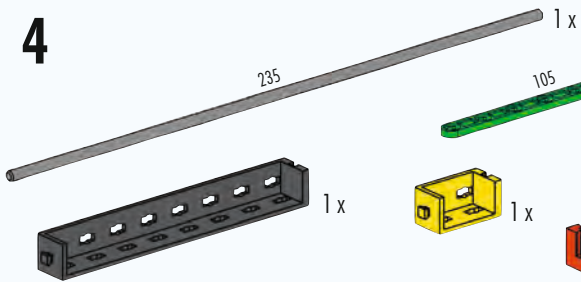

235

1x

105

2x

1x

1x

1x

3x

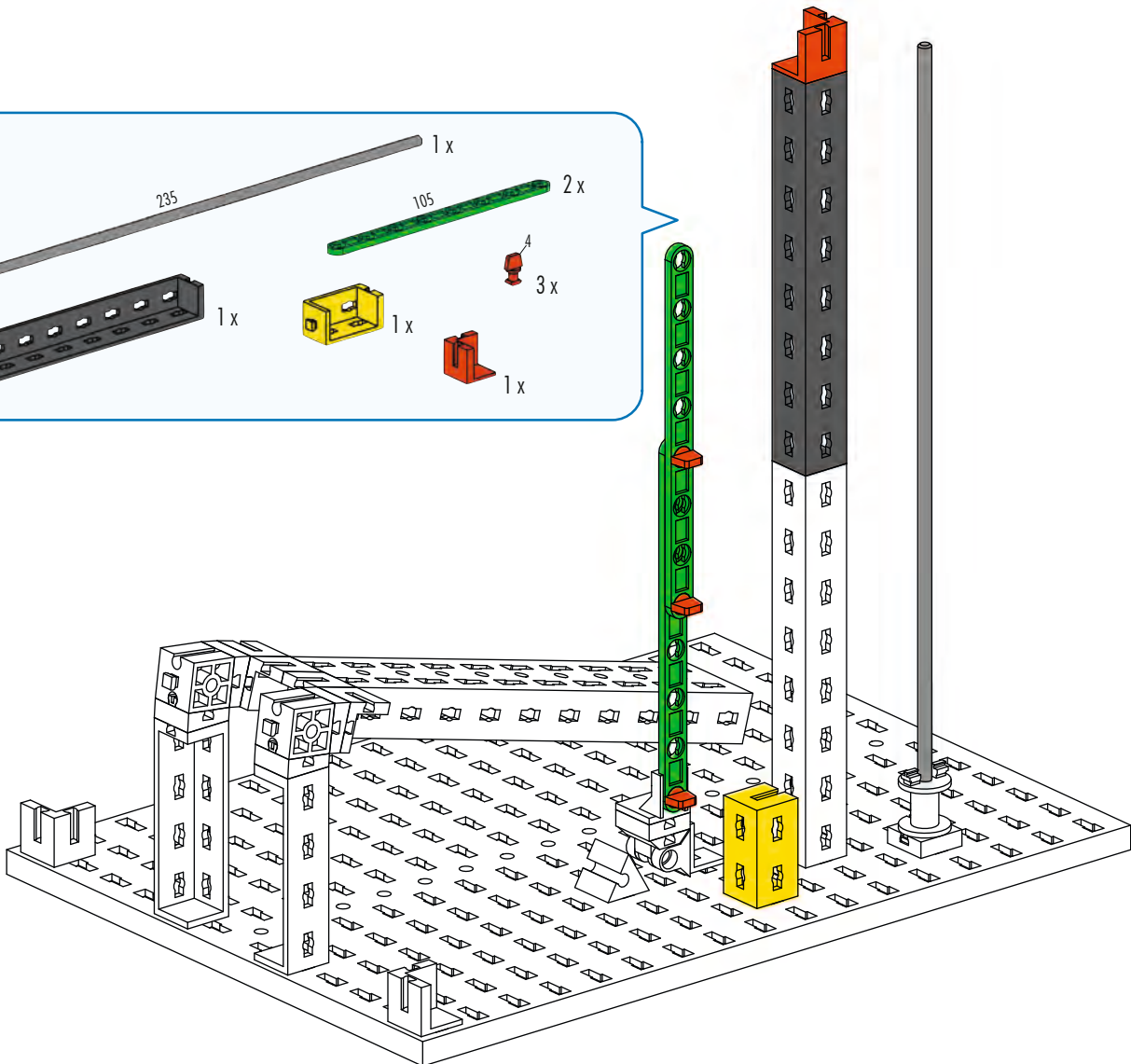

1x



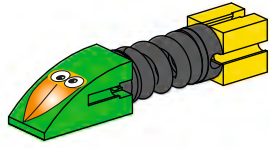



235 mm

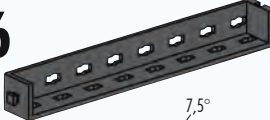
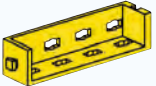

**5**

-  1x
-  1x
-  1x

**6**

-  1x
-  1x
-  1x
-  1x
-  1x
-  1x

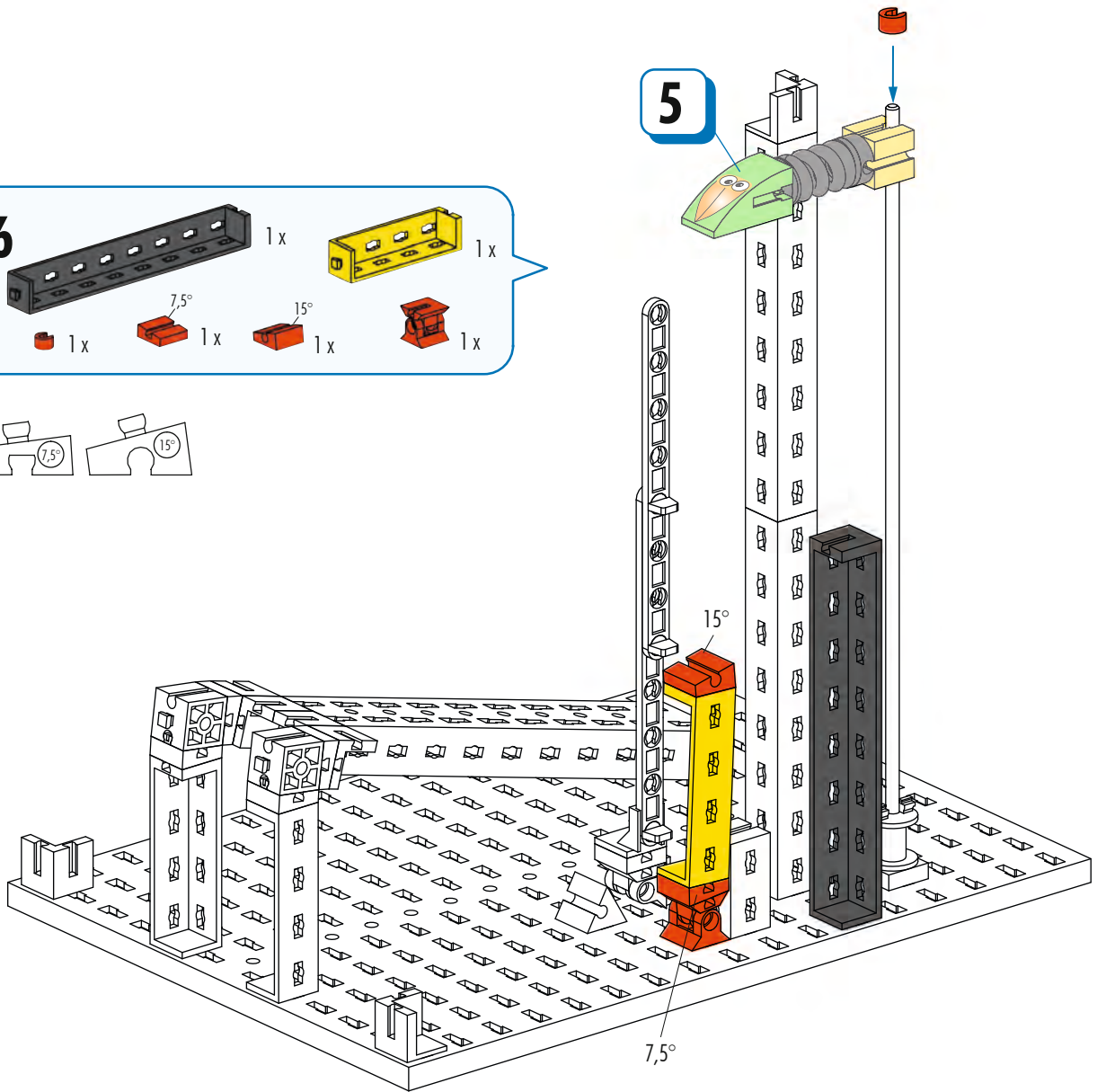
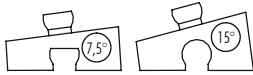



7

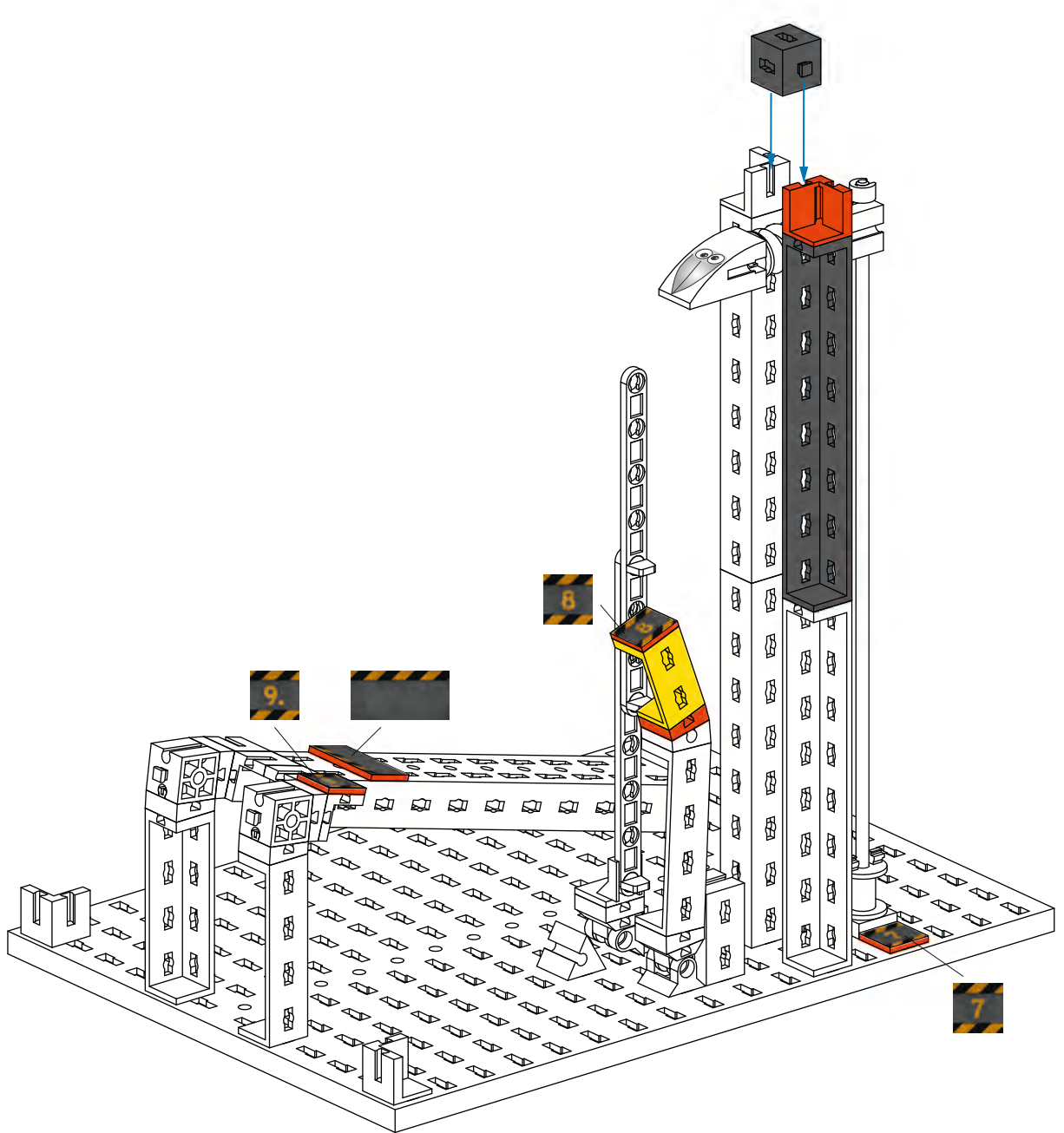
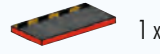
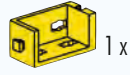
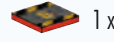
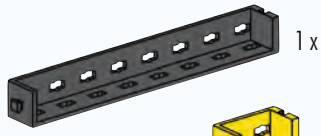

8

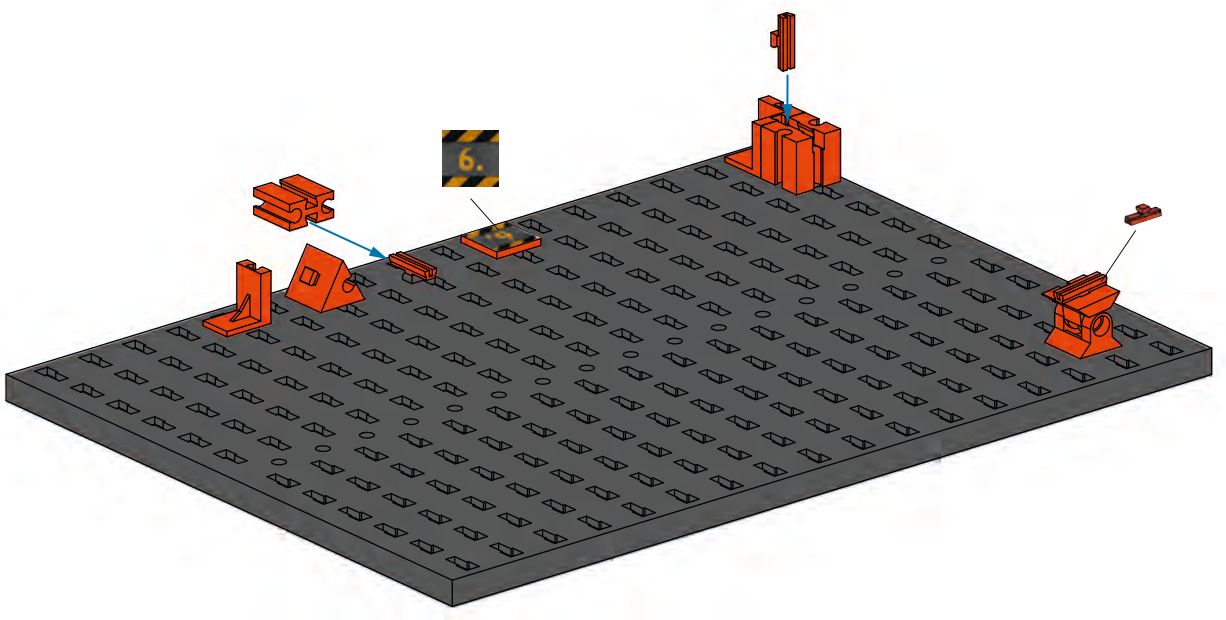
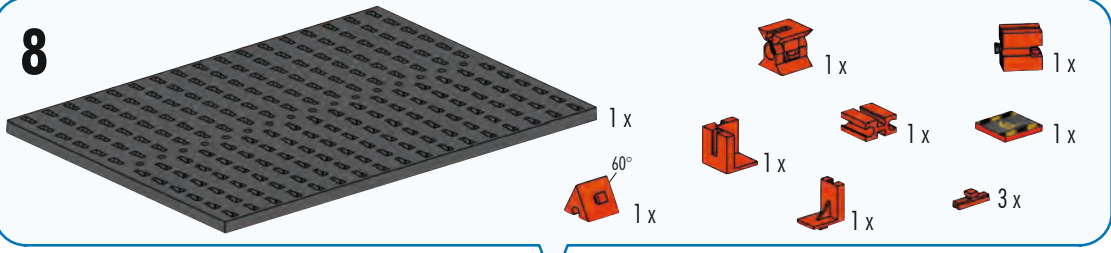

9

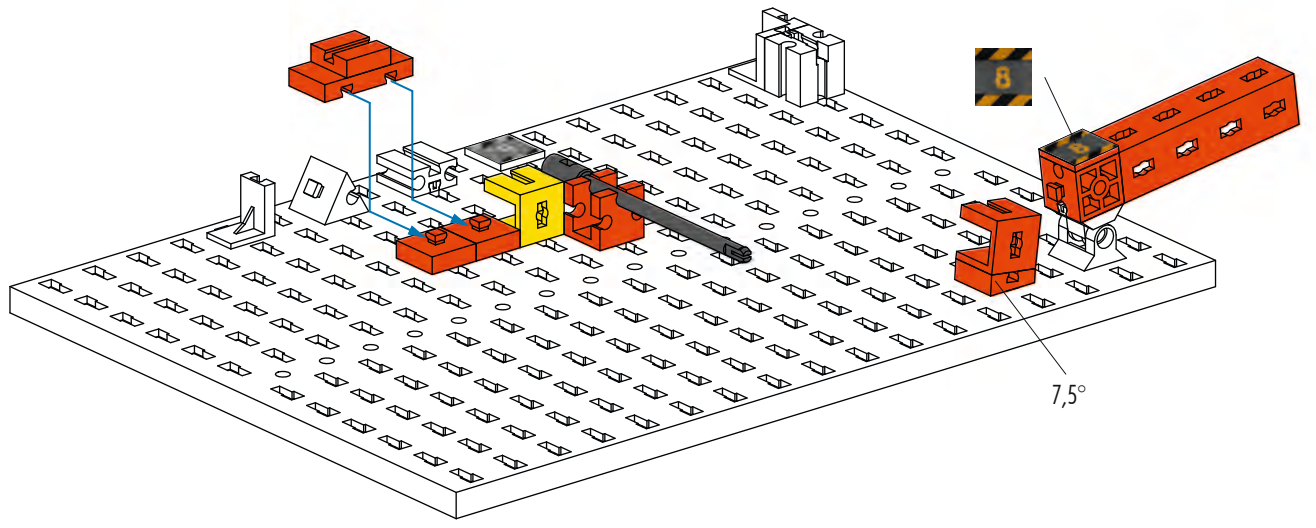
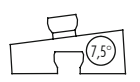
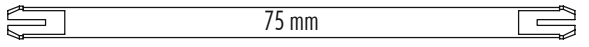
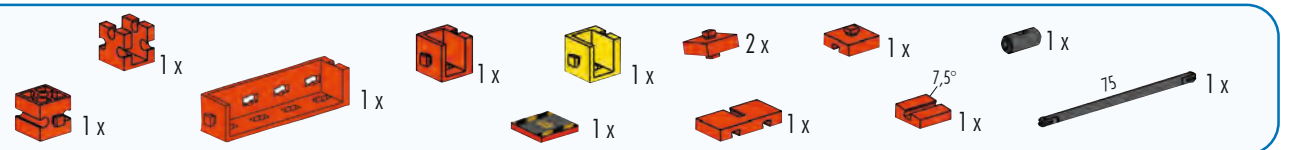



**10**

- 1x (orange 1-hole Technic brick)
- 1x (black L-shaped Technic pin)
- 1x (black Technic pin)
- 1x (red 1-hole Technic bush)
- 1x (red 1-hole Technic bush)
- 1x (black Technic pin 45)

45 mm

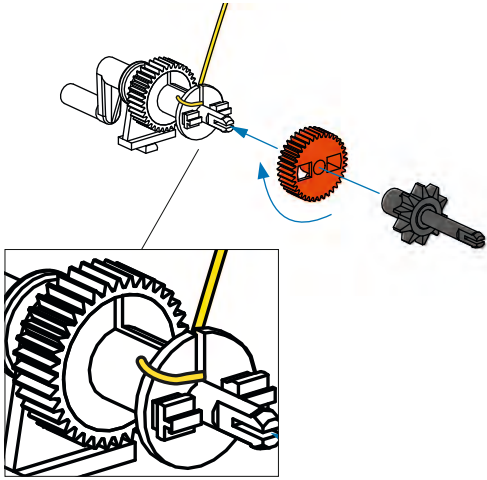
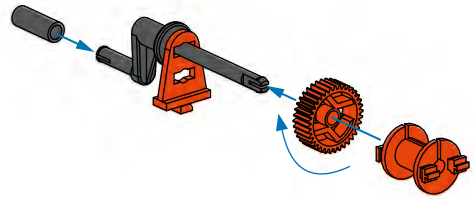

**11**

- 1x (red 1-hole Technic bush)
- 1x (yellow rubber band)
- 1x (black Technic pin)
- 1x (black Technic pin 30)

30 mm

**12**

- 1x (orange 1-hole Technic beam 11)
- 1x (orange 1-hole Technic bush)
- 1x (yellow 1-hole Technic bush)
- 1x (red 60-degree Technic wedge)
- 1x (black Technic pin)
- 1x (orange 1-hole Technic bush)
- 2x (red 1-hole Technic bush)
- 1x (red 1-hole Technic bush)

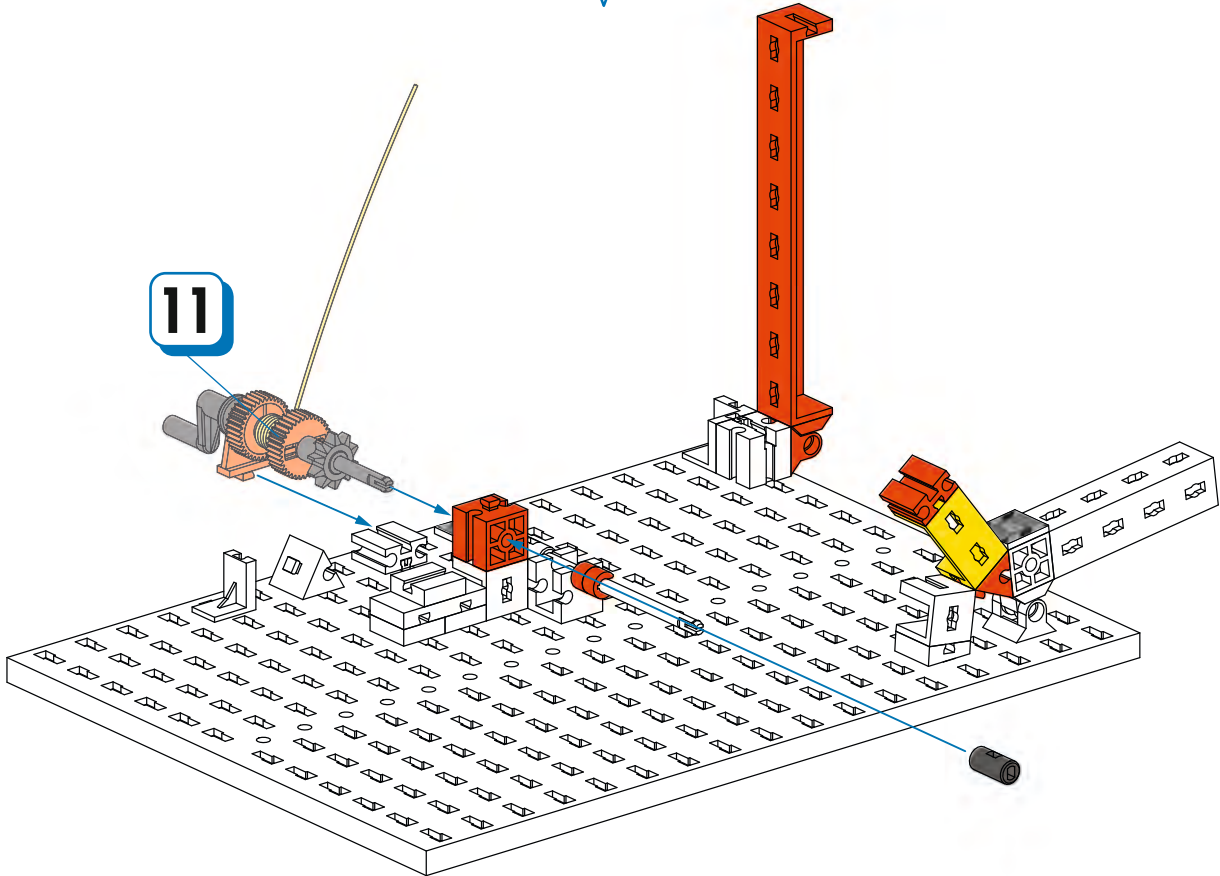





15

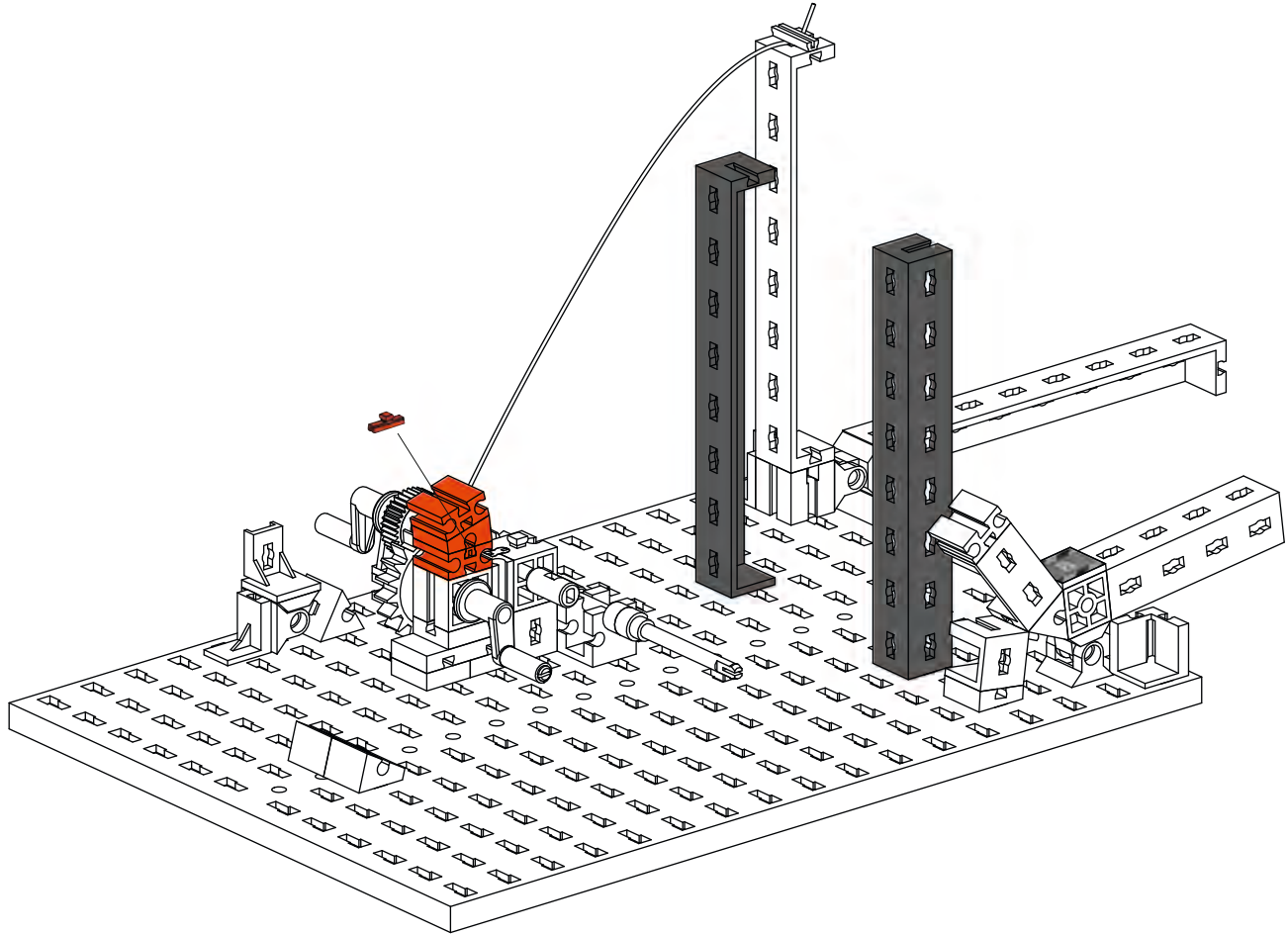
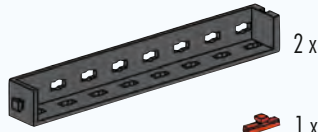

16

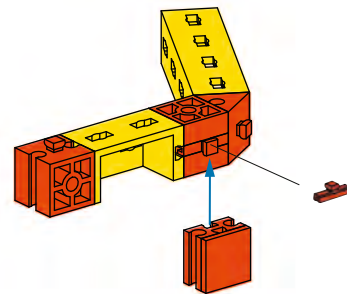
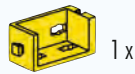
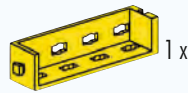

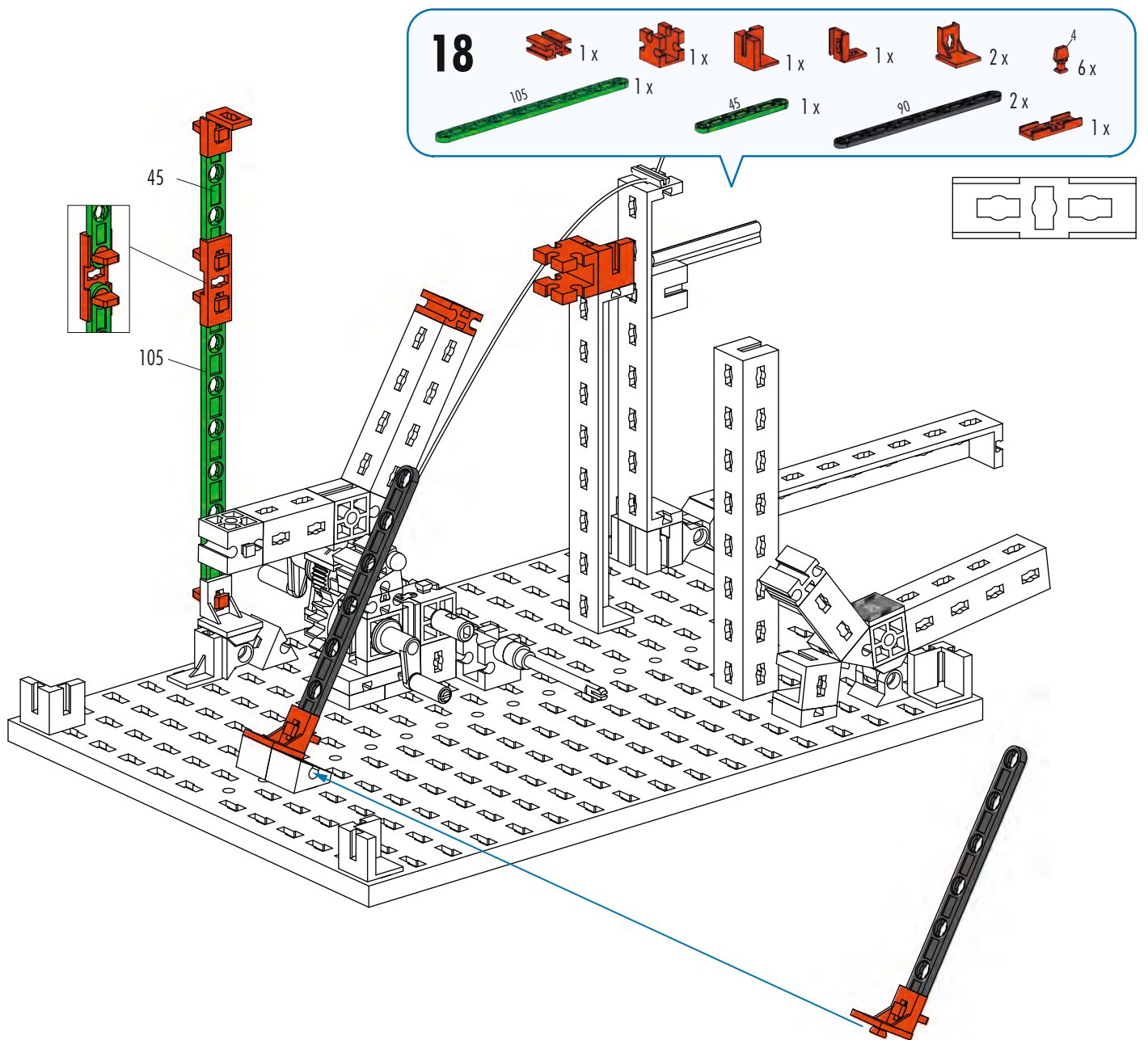
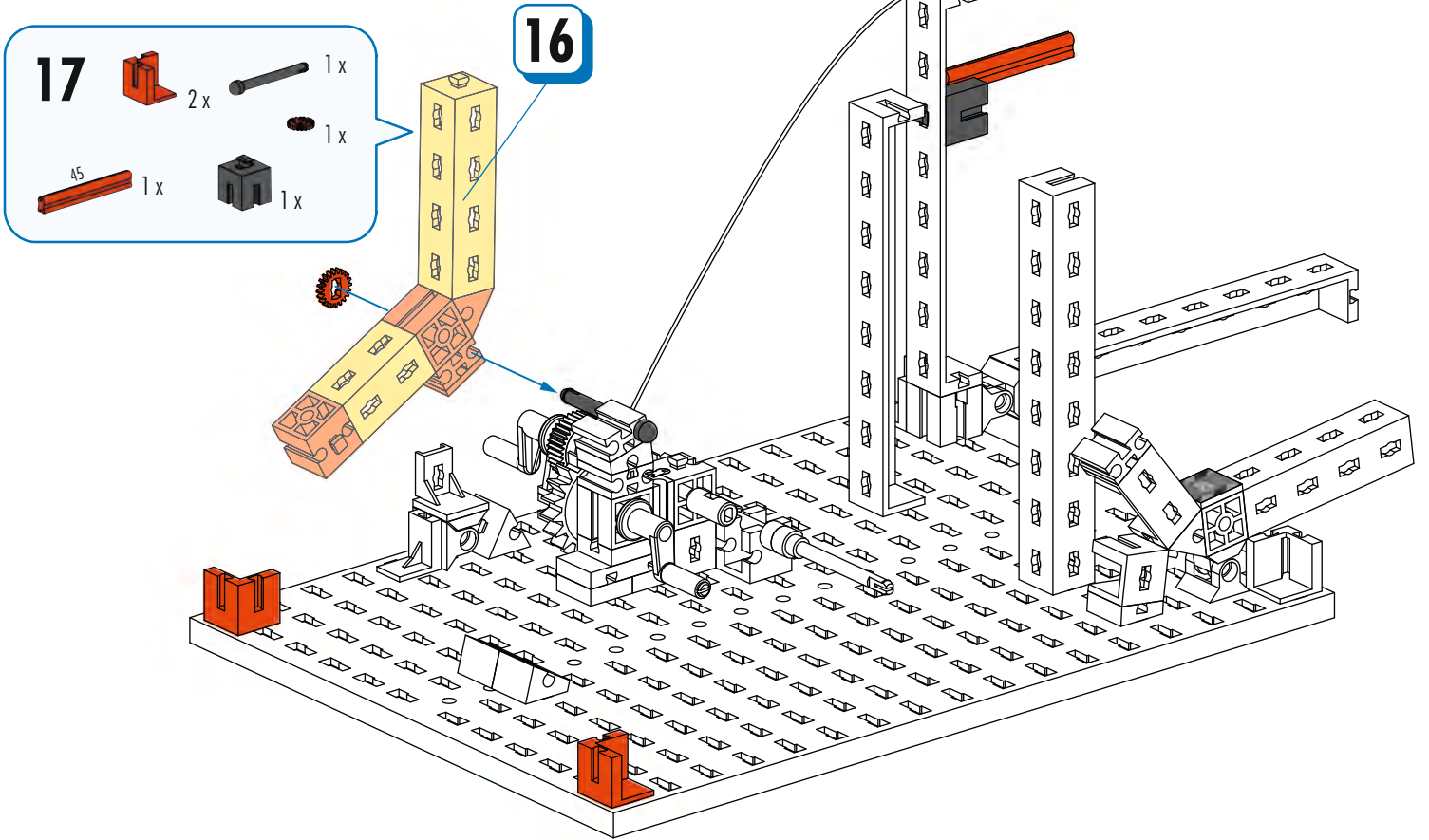





**21**

- 1x (Orange Technic Beam 1x5)
- 1x (Orange Technic Pin)
- 1x (Orange Technic Pin)
- 1x (Orange Technic Pin)

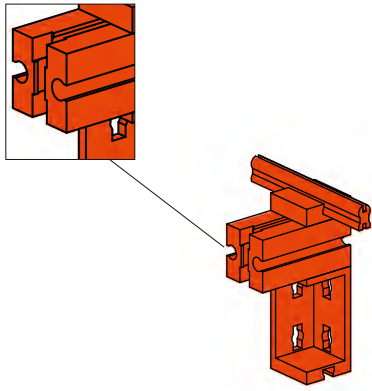

**22**

- 1x (Orange Technic Beam 1x5)
- 1x (Orange Technic Pin)
- 1x (Grey Technic Pin)
- 1x (Orange Technic Pin)
- 2x (Orange Technic Pin)
- 1x (Orange Technic Pin)

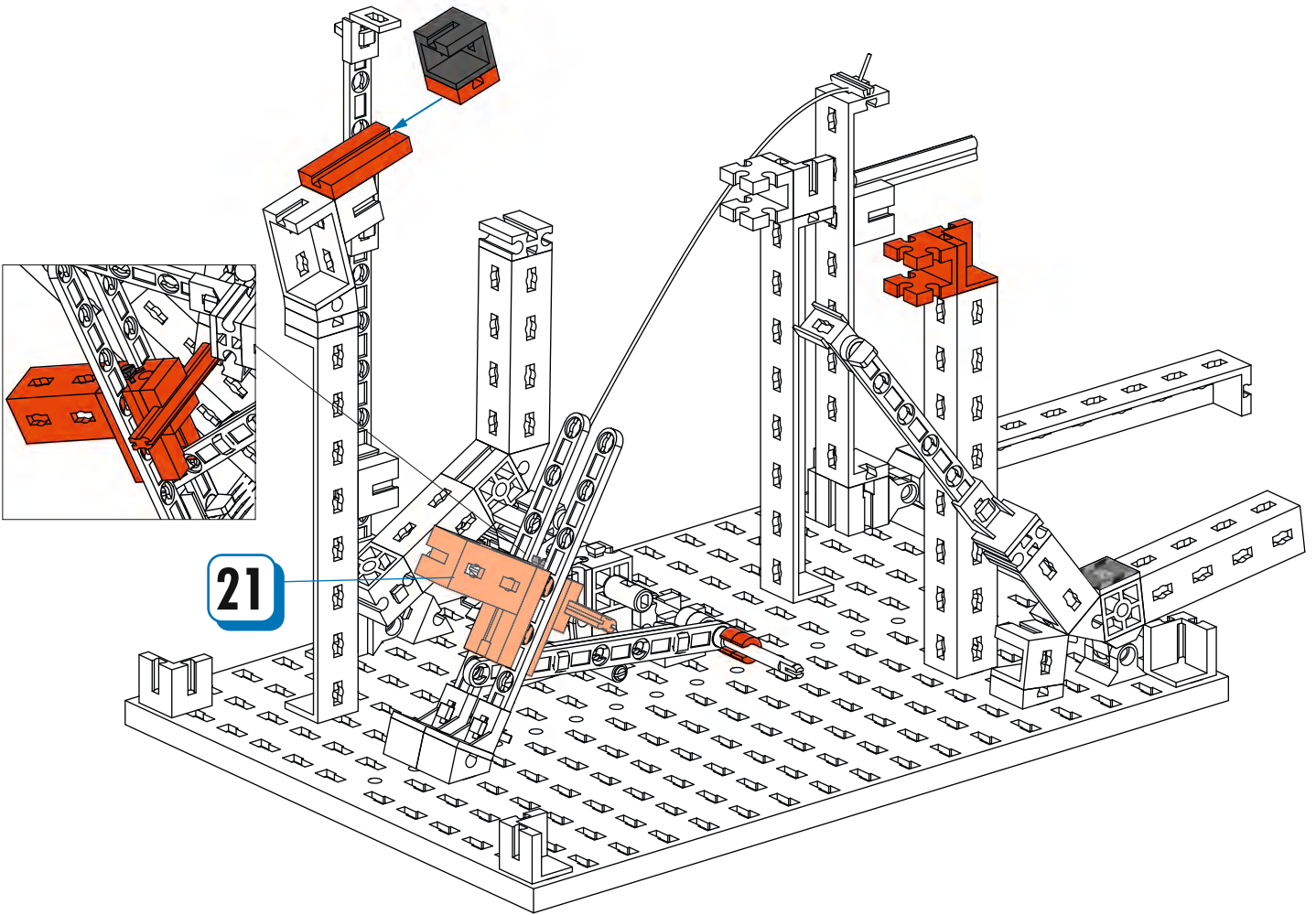

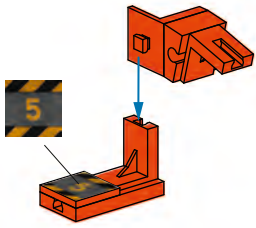

**23** 1x 1x 2x 1x 1x 1x

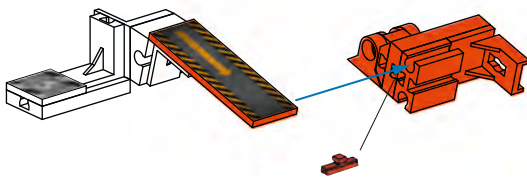
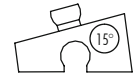

**24** 1x 1x 1x 1x 1x 1x

**25** 30 1x 1x 2x

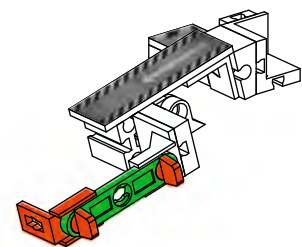



26

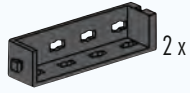

25

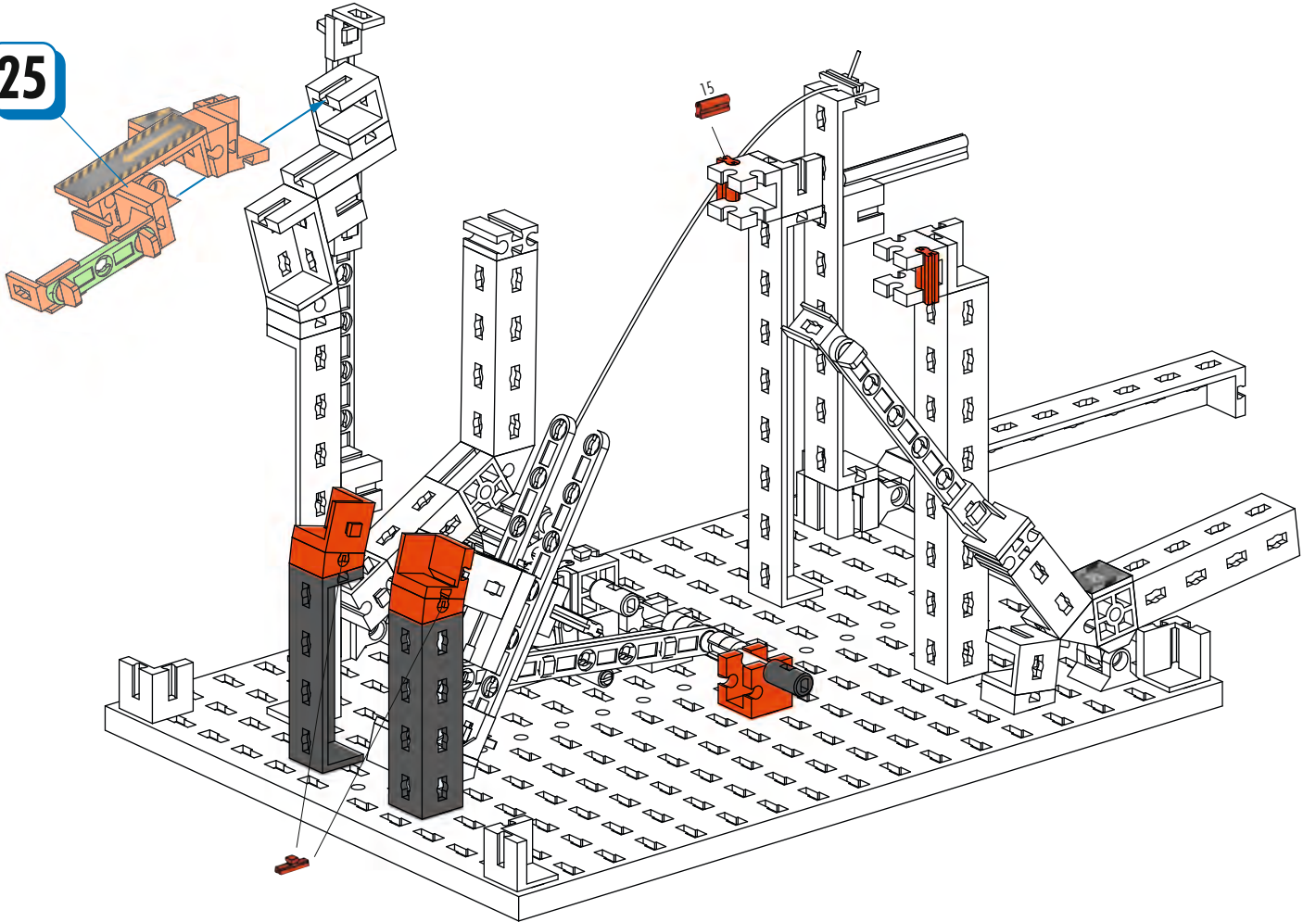

27

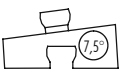
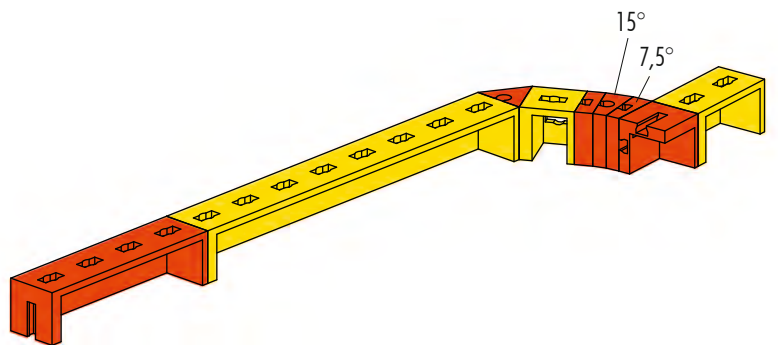
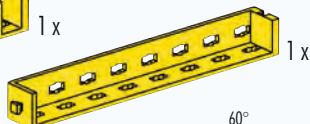
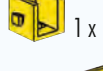

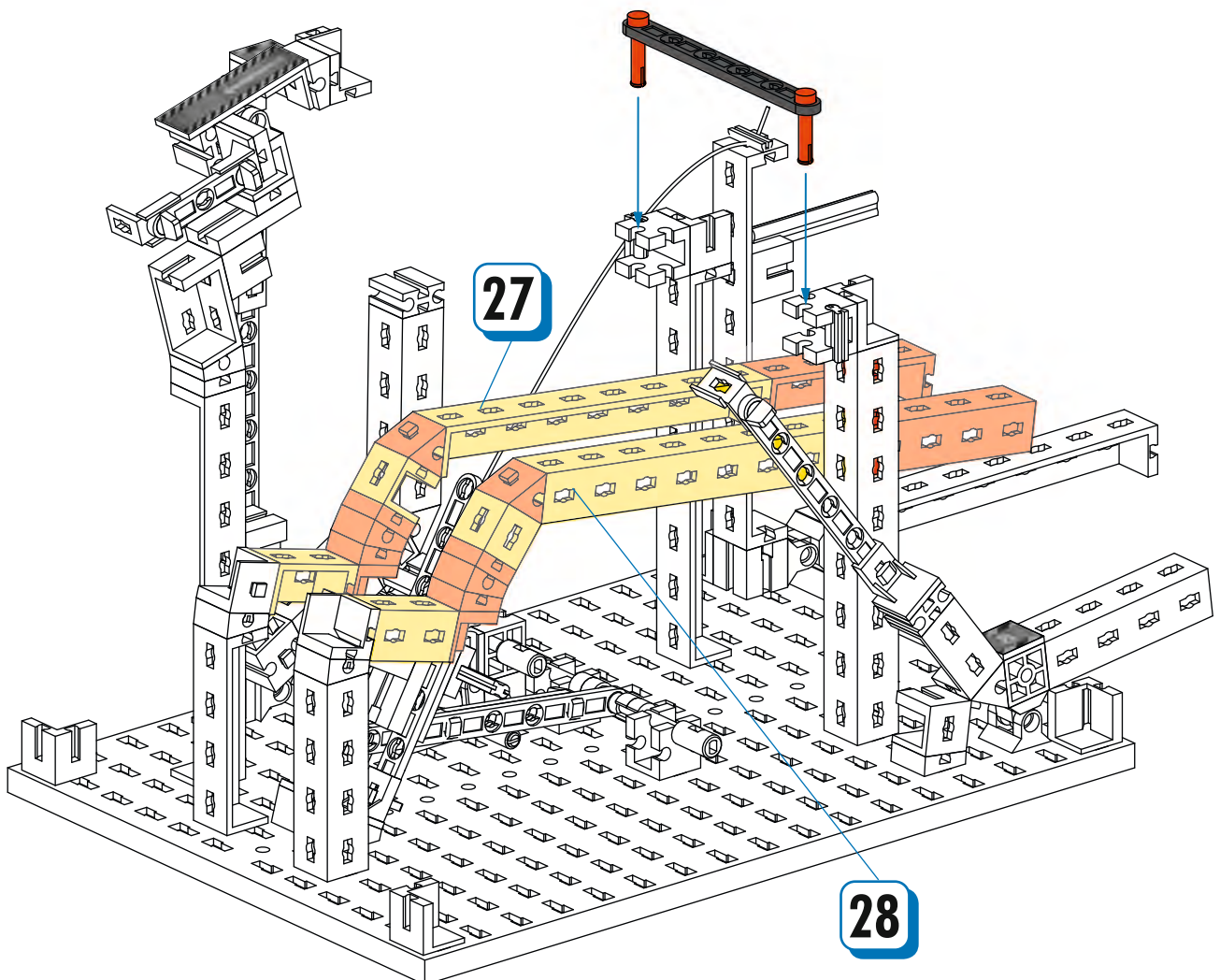
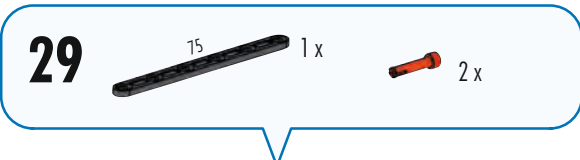
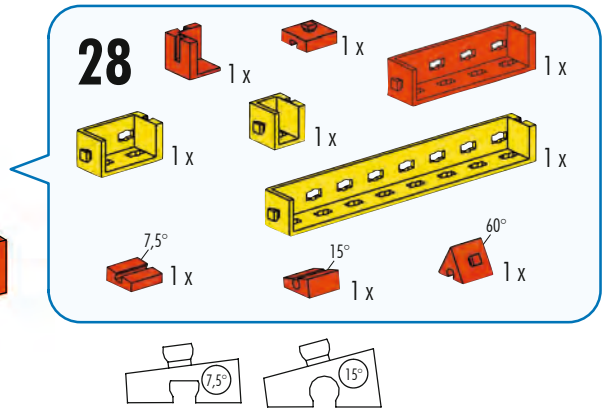
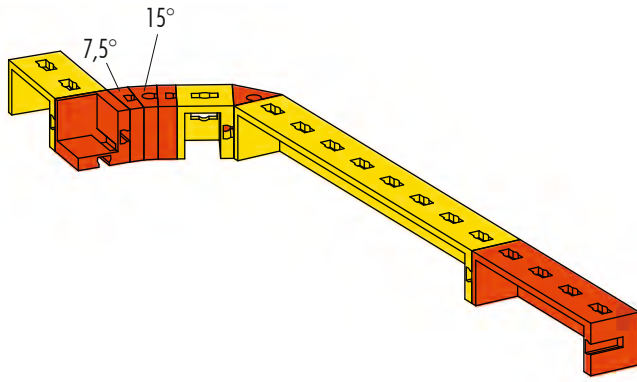

30



1x

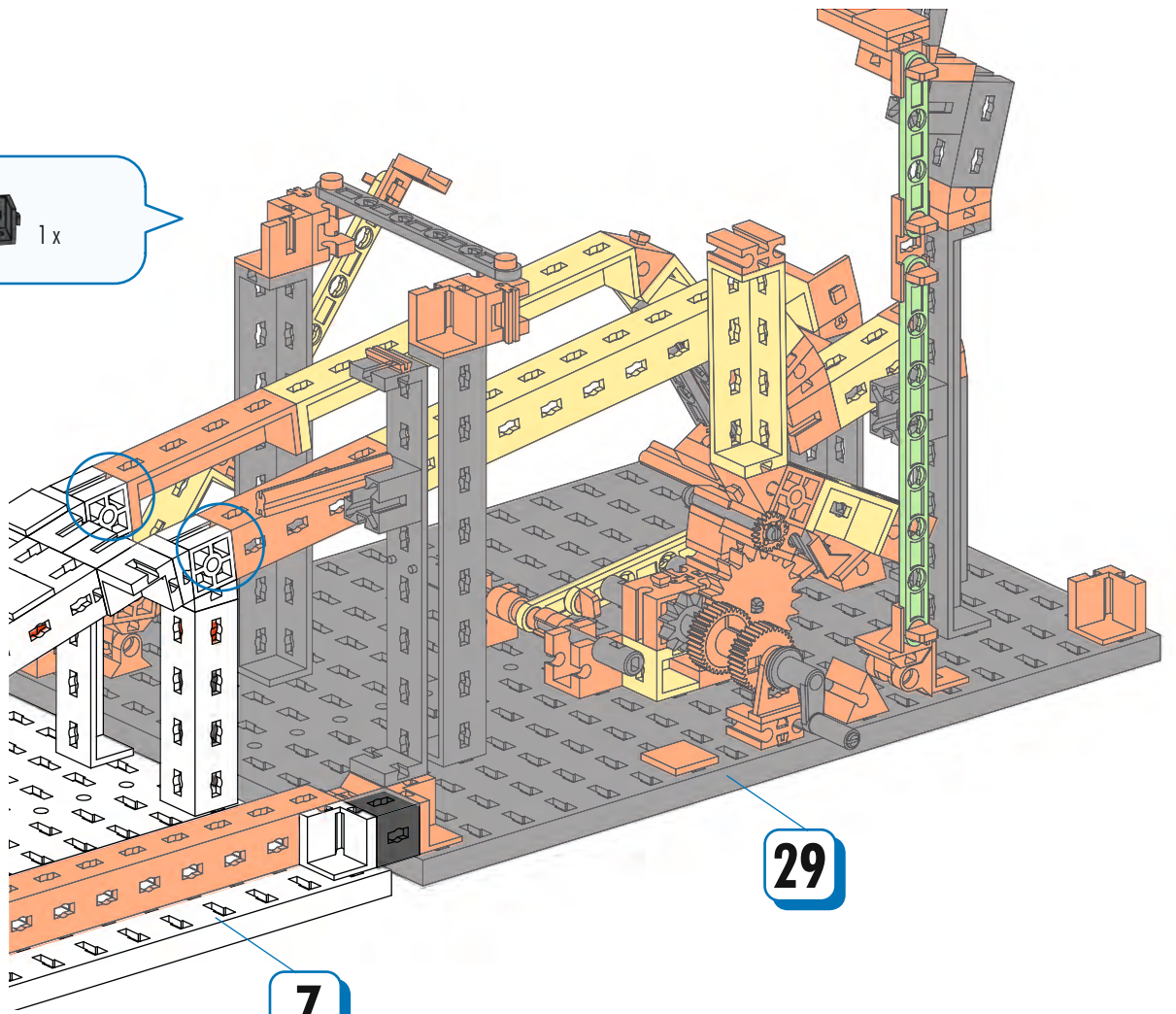

29

7

31



1x



2x



1x



1x



1x



4x



1x



1x



1x

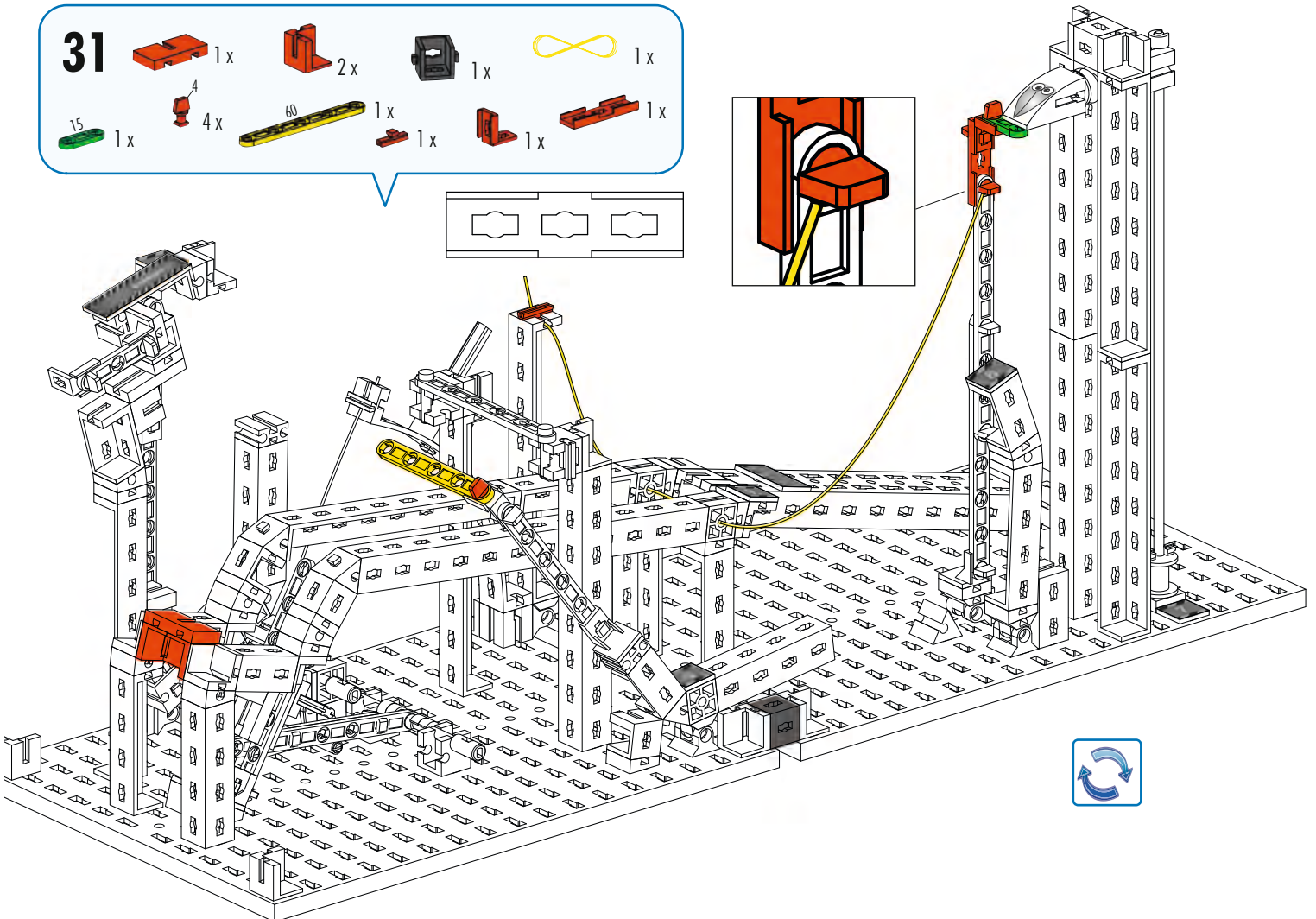
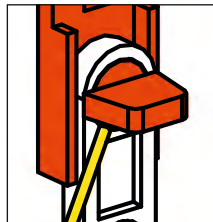
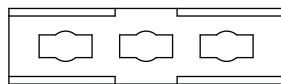





**34**

- 60 1x
- 1x
- 1x
- 1x

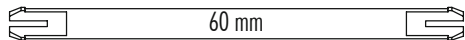
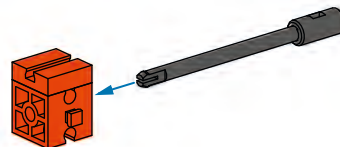

**35**

- 1x
- 1x
- 1x
- 4
- 45 1x
- 2x
- 1x
- 2x
- 1x
- 1x
- 106 1x

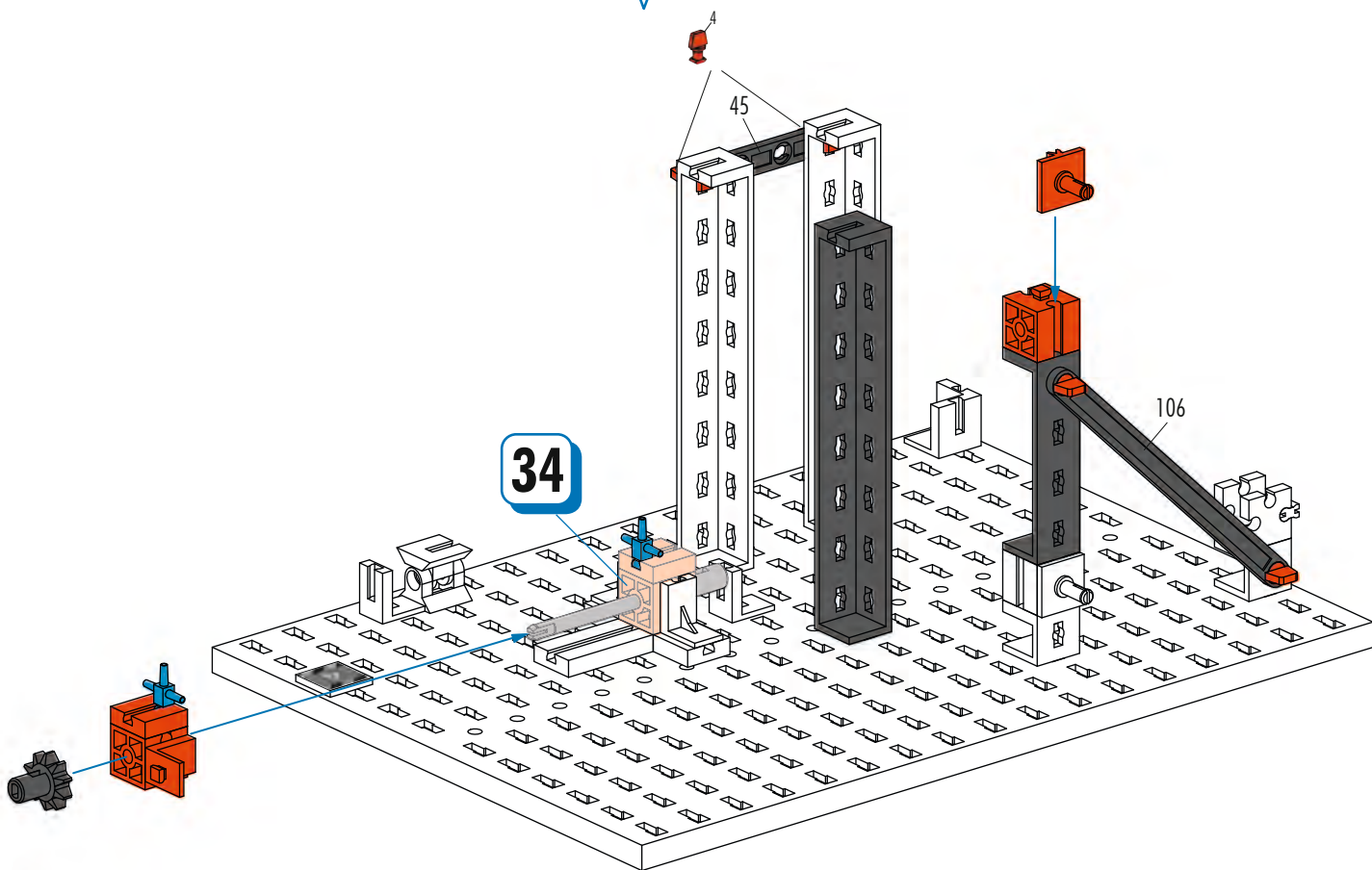

36

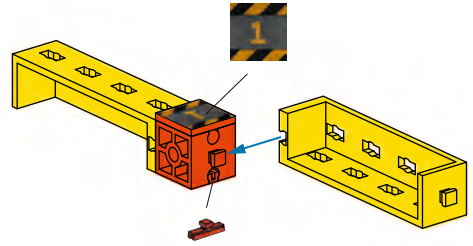

37

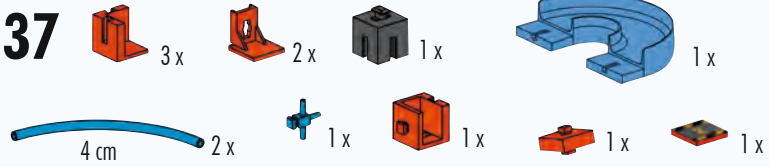

36

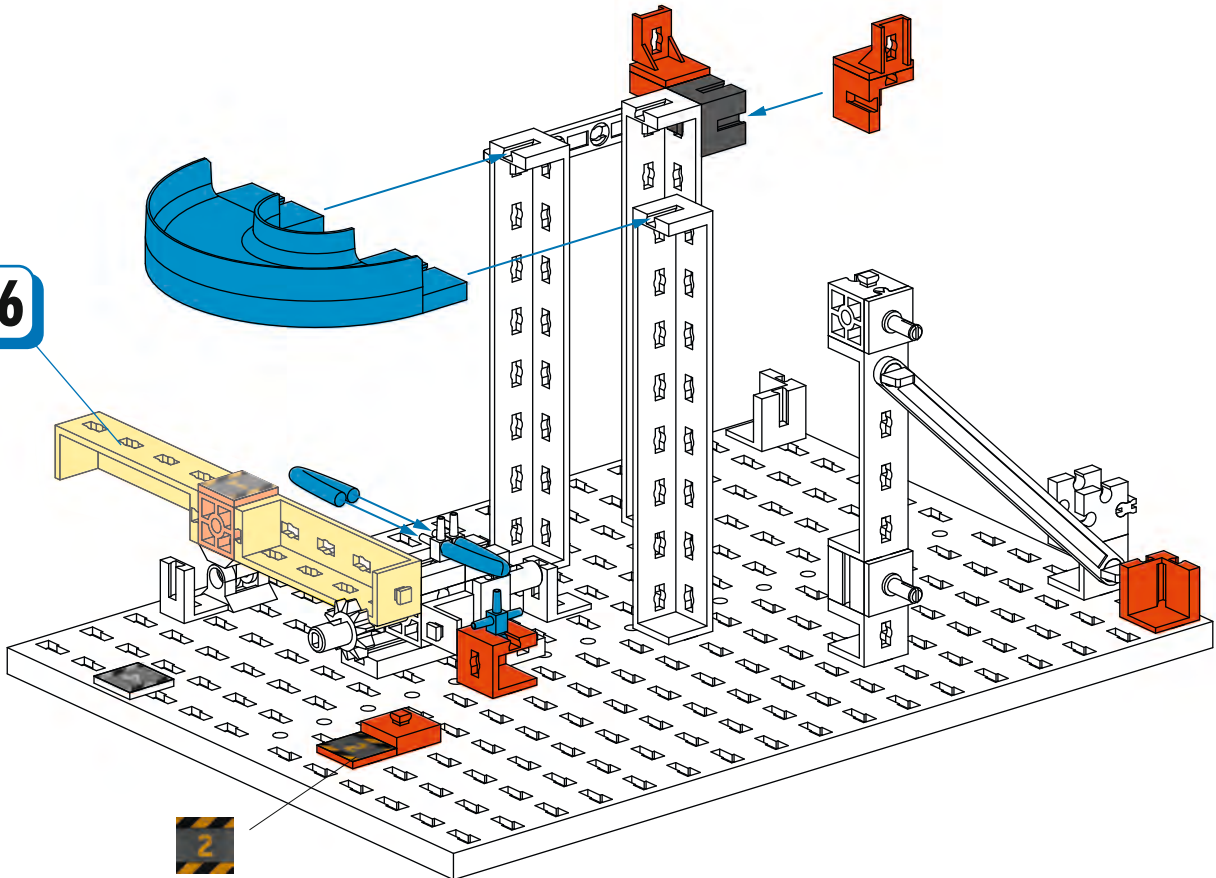



# 38

- 1x Orange Technic Beam 10 holes
- 1x Red Technic Connector
- 1x Black Technic Connector
- 1x Red Technic Pin A
- 1x Yellow Technic Pin 30
- 1x Red Technic Pin
- 1x Red Technic Pin

# 39

- 1x Black Technic Connector
- 1x Red Technic Pin
- 1x Black Technic Connector
- 1x White Technic Pin
- 2x Blue Technic Cable 8 cm
- 1x Black Technic Connector

# 38

The diagram shows a robot chassis with several vertical beams and a motor. A blue cable is connected to the motor. A callout box shows a close-up of the motor and cable assembly, with the blue cable connected to a black connector on the motor.

**40**

90 1x  
 2x  
 1x  
 1x

90 mm

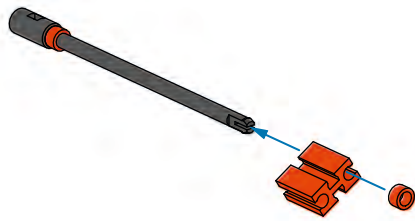

**41**

2x  
 1x  
 4x  
 1x  
 3x  
 2x  
 1x  
 1x  
 120  
 42,4

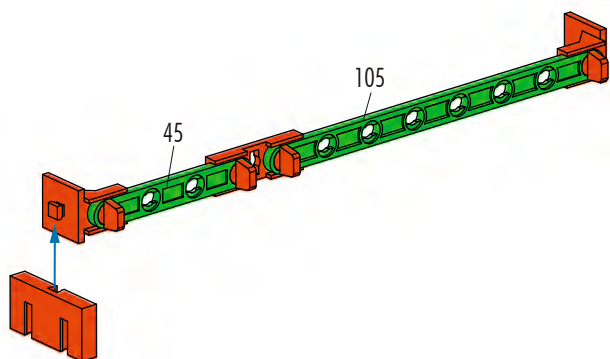
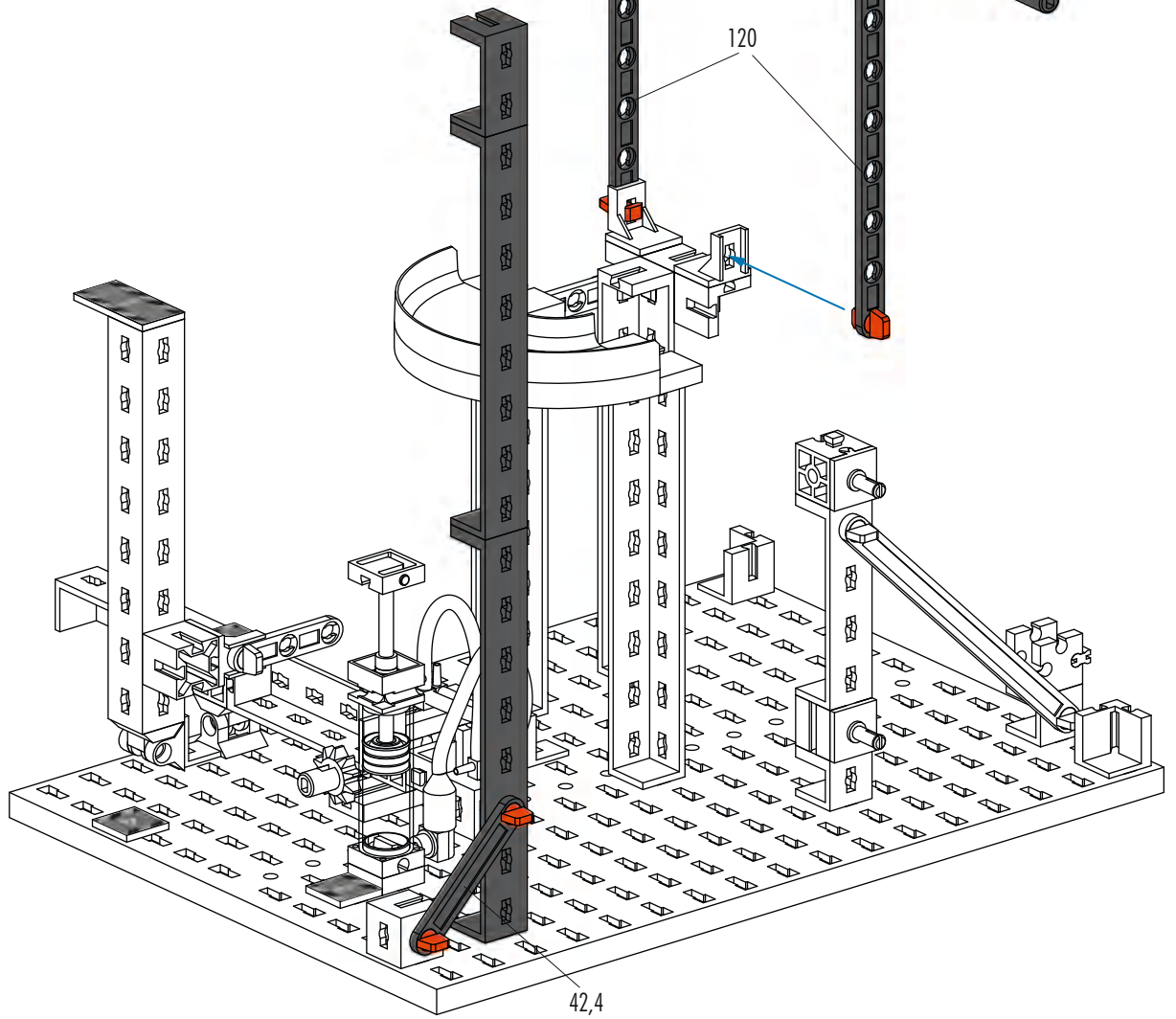
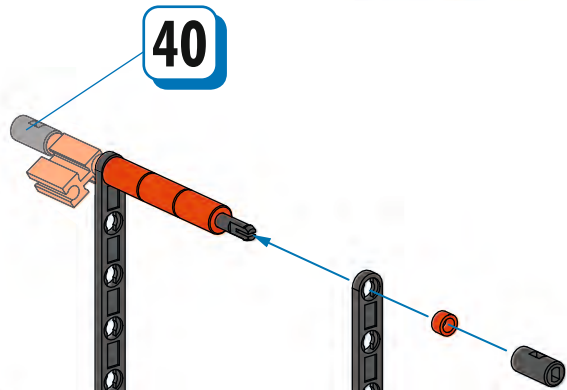

**42**

45 1x  
 105 1x  
 2x  
 4x  
 1x  
 1x

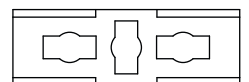

43

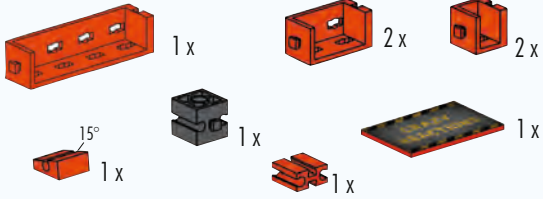

Große Bohrung  
 Large drilling  
 Alésage large  
 Grote boring  
 Perforación grande  
 Orificio grande  
 Grande foro  
 Большое отверстие  
 大孔

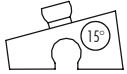
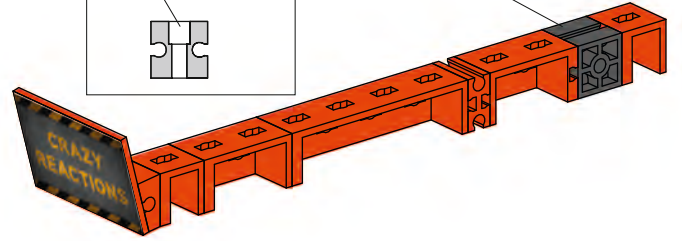

44

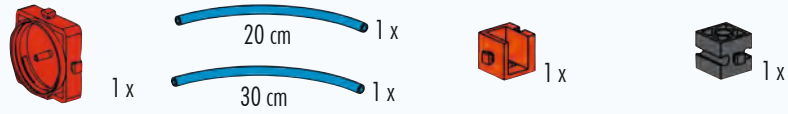

! oder  
 or  
 ou  
 of  
 o  
 o  
 или  
 或

Montagetipps Seite 2 / Tips for assembly Page 2 / Tuyaux pour le montage page 2 / Montagetips zie bladzijde 2 / Consejos para el montaje, ver la página 2 / "Dicas" para montagem - Página 2 / Consigli per il montaggio, pagina 2 / Советы по сборке, страница 2 / 装配建议第2页

42

Große Bohrung  
 Large drilling  
 Alésage large  
 Grote boring  
 Perforación grande  
 Orificio grande  
 Grande foro  
 Большое отверстие  
 大孔

43

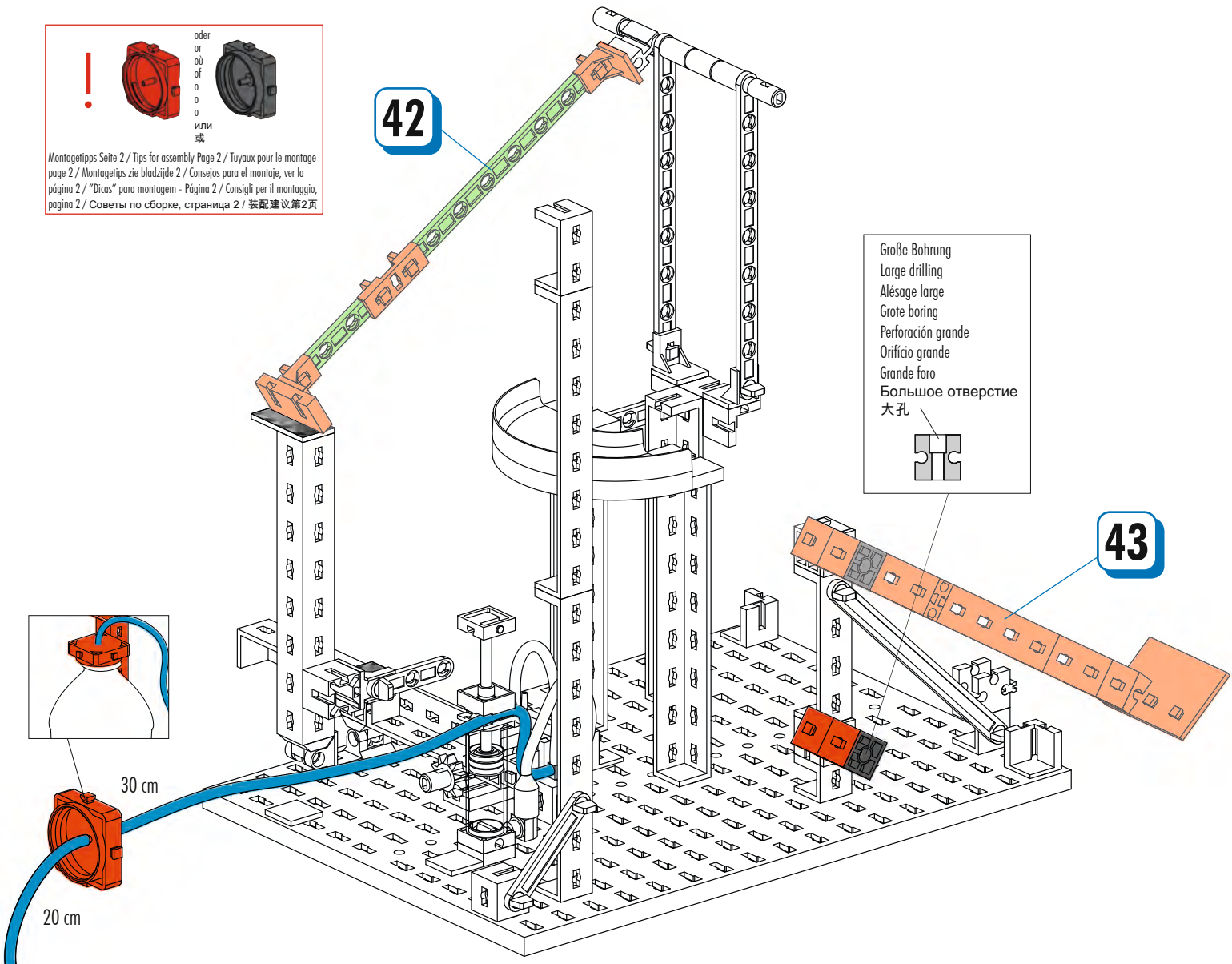



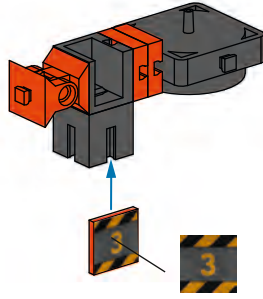

  
 oder  
 or  
 ou  
 of  
 o  
 o  
 o  
 o  
 или  
 или  
 或

Montage tips Seite 2 / Tips for assembly Page 2 / Tuyaux pour le montage  
 page 2 / Montage tips zie bladzijde 2 / Consejos para el montaje, ver la  
 página 2 / "Dicas" para montagem - Página 2 / Consigli per il montaggio,  
 pagina 2 / Советы по сборке, страница 2 / 装配建议第2页

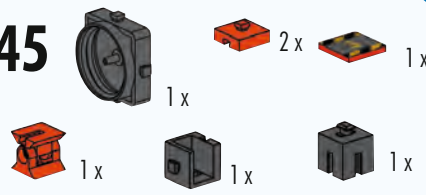

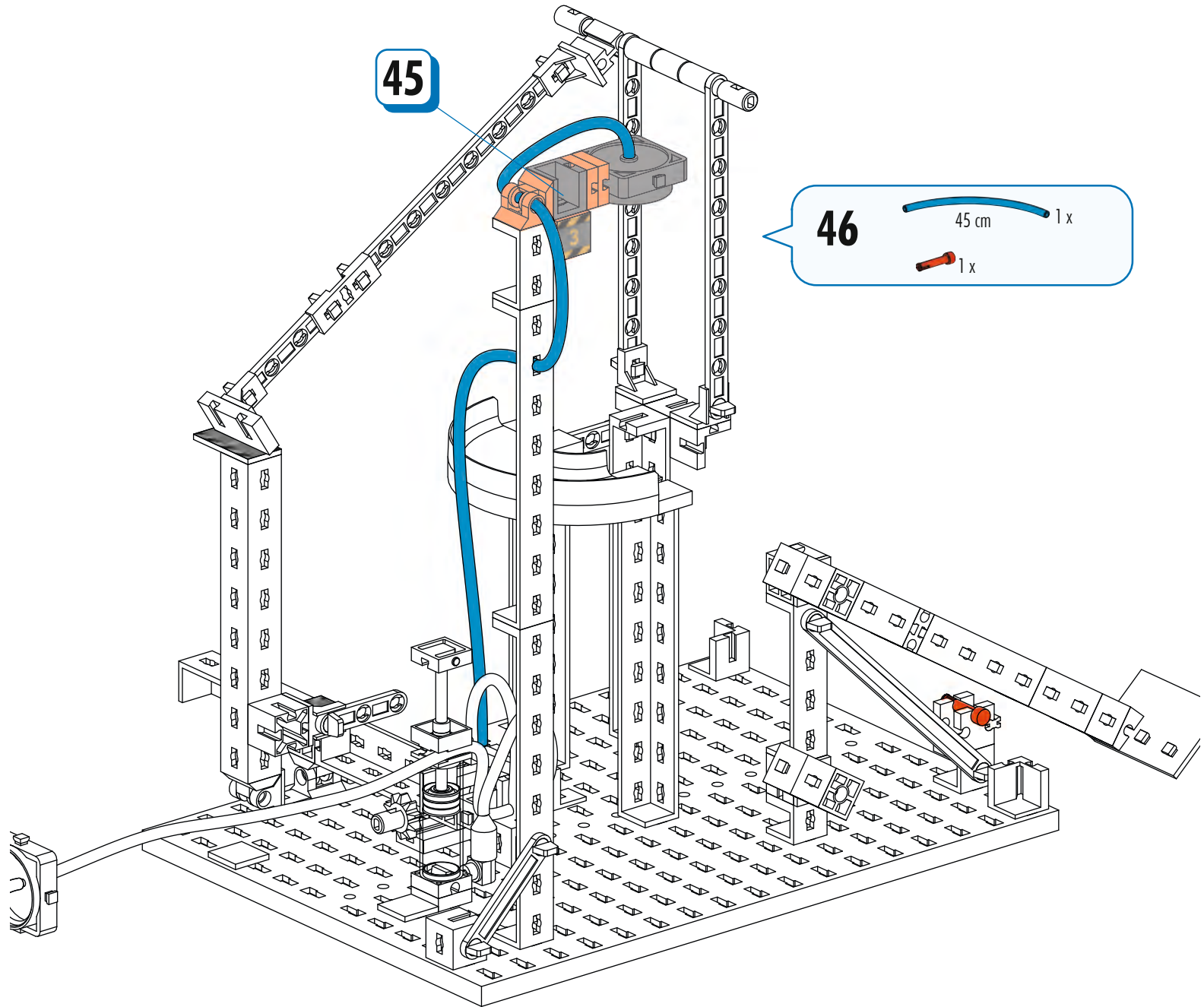
**45**
  

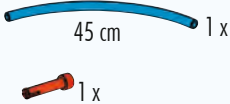
  
 1 x    2 x    1 x  
 1 x    1 x    1 x



**46**
  

  
 45 cm    1 x  
 1 x

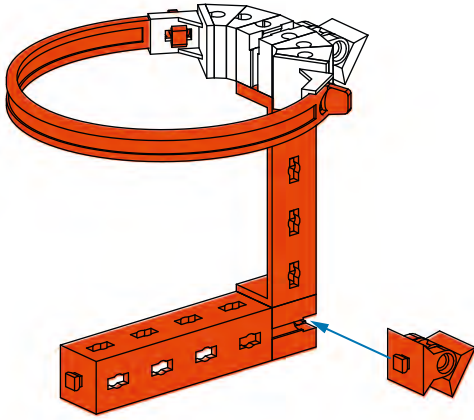
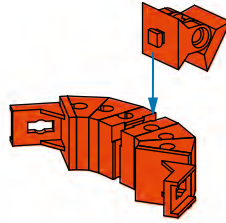
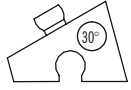
47

- 1 x [1x2 Technic Brick]
- 4 x [30° Technic Connector]
- 2 x [L-shaped Technic Connector]
- 1 x [1x2 Technic Brick]



48

- 1 x [1x2 Technic Brick]
- 1 x [1x2 Technic Brick]
- 2 x [1x2 Technic Brick]
- 2 x [Pin A]
- 1 x [169.6 Technic Beam]

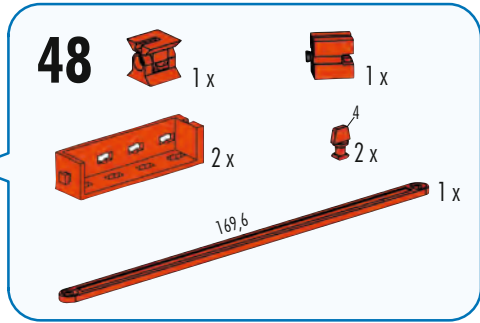



49

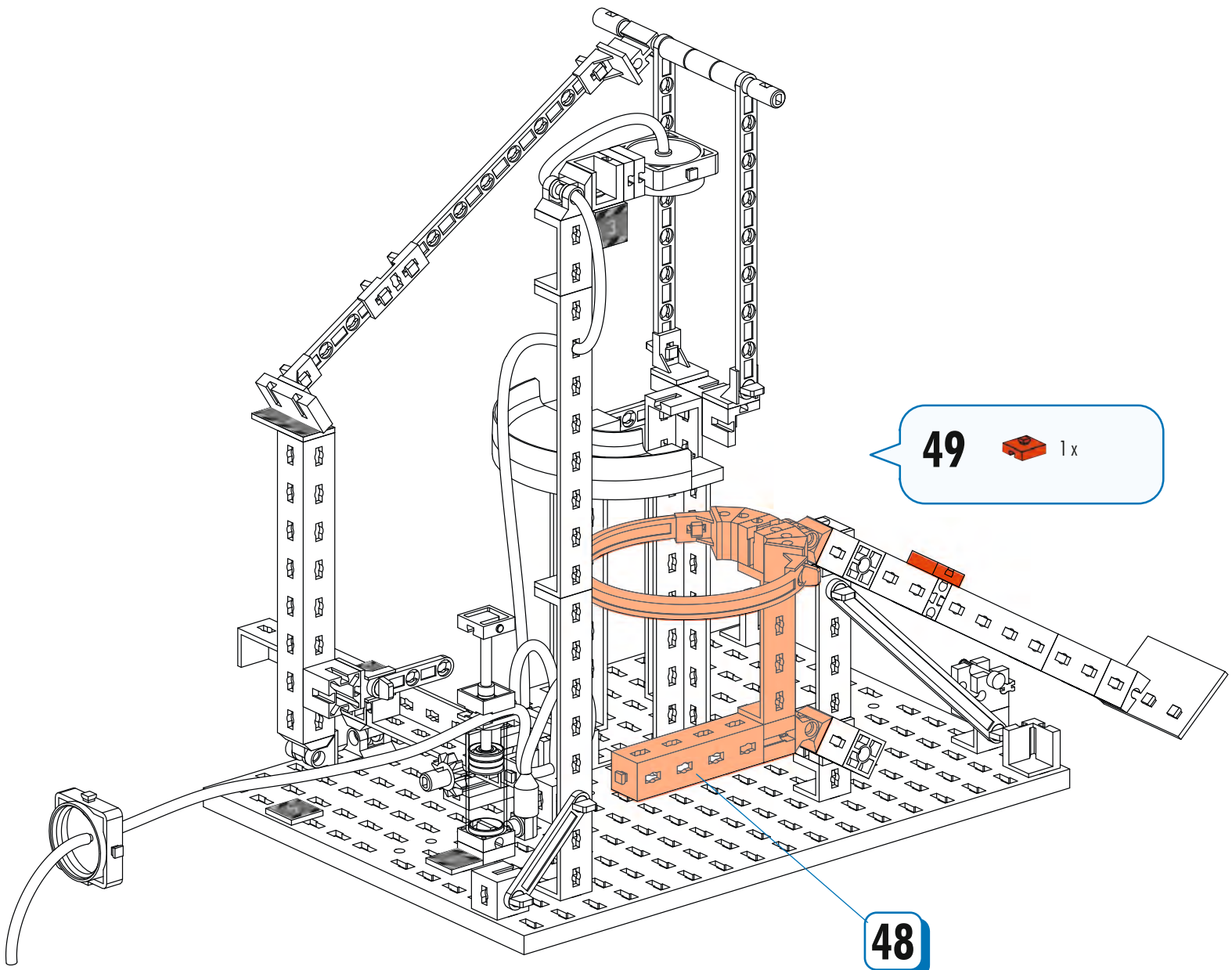

- 1 x [1x2 Technic Brick]

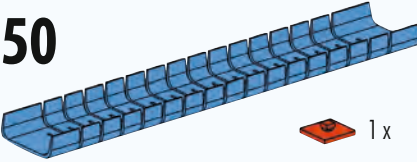

48

**50**

2x  1x  1x

1x  1x  1x 2x 

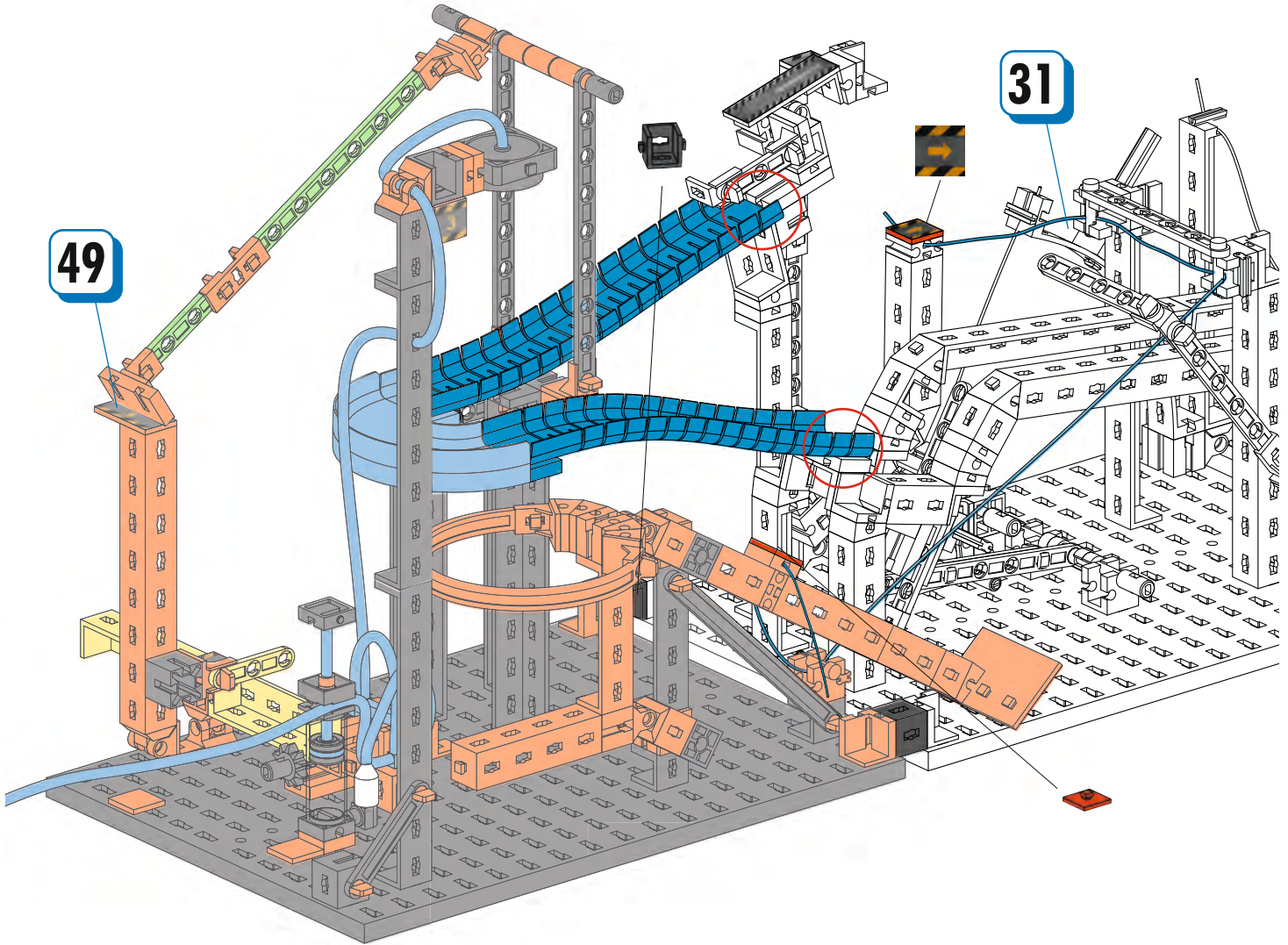

Seillänge  
Rope length  
Longueur du câble

Touwlänge  
Longitud de la cuerda  
Длина каната  
Comprimento da corda

Lunghezza della corda  
Длина каната  
繩索長度

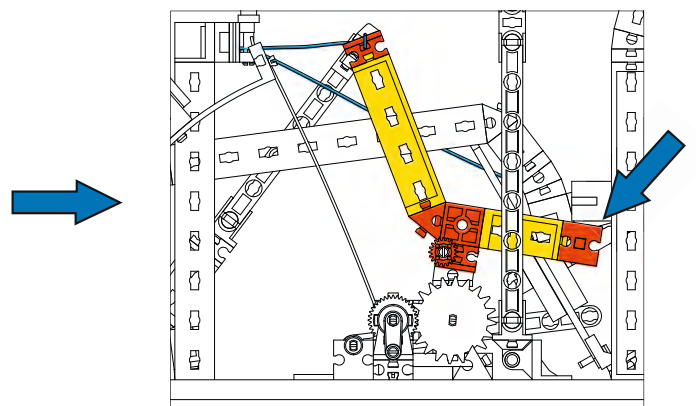
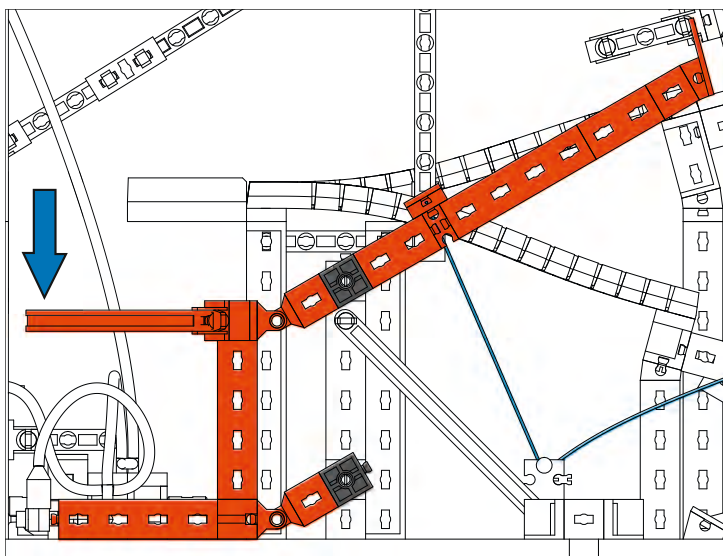



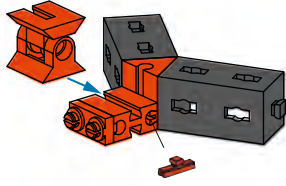

**51**

- 2 x [Grey Technic Box]
- 1 x [Red 60° Technic Triangle]
- 1 x [Red Technic Pin]
- 1 x [Red Technic Pin]
- 1 x [Red Technic Pin]
- 1 x [Red Technic Pin]

**52**

- 2 x [Red Technic Pin]
- 1 x [Red Technic Pin]
- 1 x [Red Technic Pin]
- 1 x [Red Technic Pin]

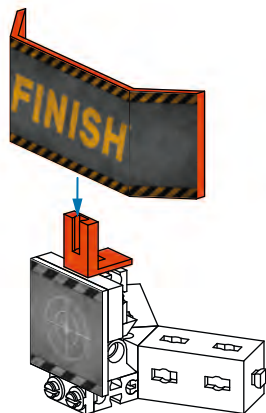
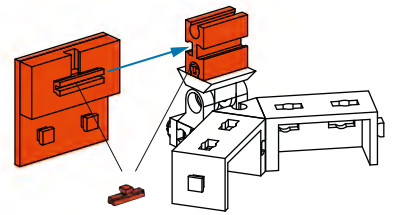

**53**

- 1 x [Red Technic Pin]
- 1 x [Red Technic Pin]

54



1x



1x

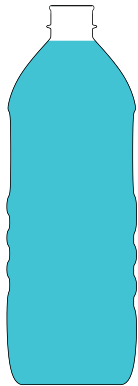
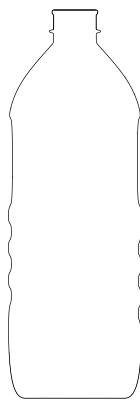

- Tipps und Tricks zur Inbetriebnahme der Modelle
- Tips and tricks for commissioning the models
- Conseils et astuces pour la mise en service des modèles
- Tips en trucs voor het in opdracht geven van de modellen
- Consejos y trucos para encargar las maquetas
- Dicas e truques para o comissionamento dos modelos
- Consigli e suggerimenti per la messa in servizio dei modelli
- Советы и рекомендации по вводу моделей в эксплуатацию
- 调调试模型的技巧+诀窍

- Kombiniere deine Modelle
- Combine your models
- Combine tes modèles
- Combineer je modellen
- Combine sus modelos
- Combine seus modelos
- Combinare i modelli
- Объедините свои модели
- 结合你的模型



<https://www.fischertechnik.de/crazyreactions-tutorials>



LED Set 533 877

**1**

- 1x (Red L-shaped Technic brick)
- 4x (White 1x2 Technic brick)
- 1x (Red 1x2 Technic brick)
- 1x (Black 1x2 Technic brick)
- 2x (White LED bulb with label 'W')
- 2x (Red LED bulb with label 'RB')

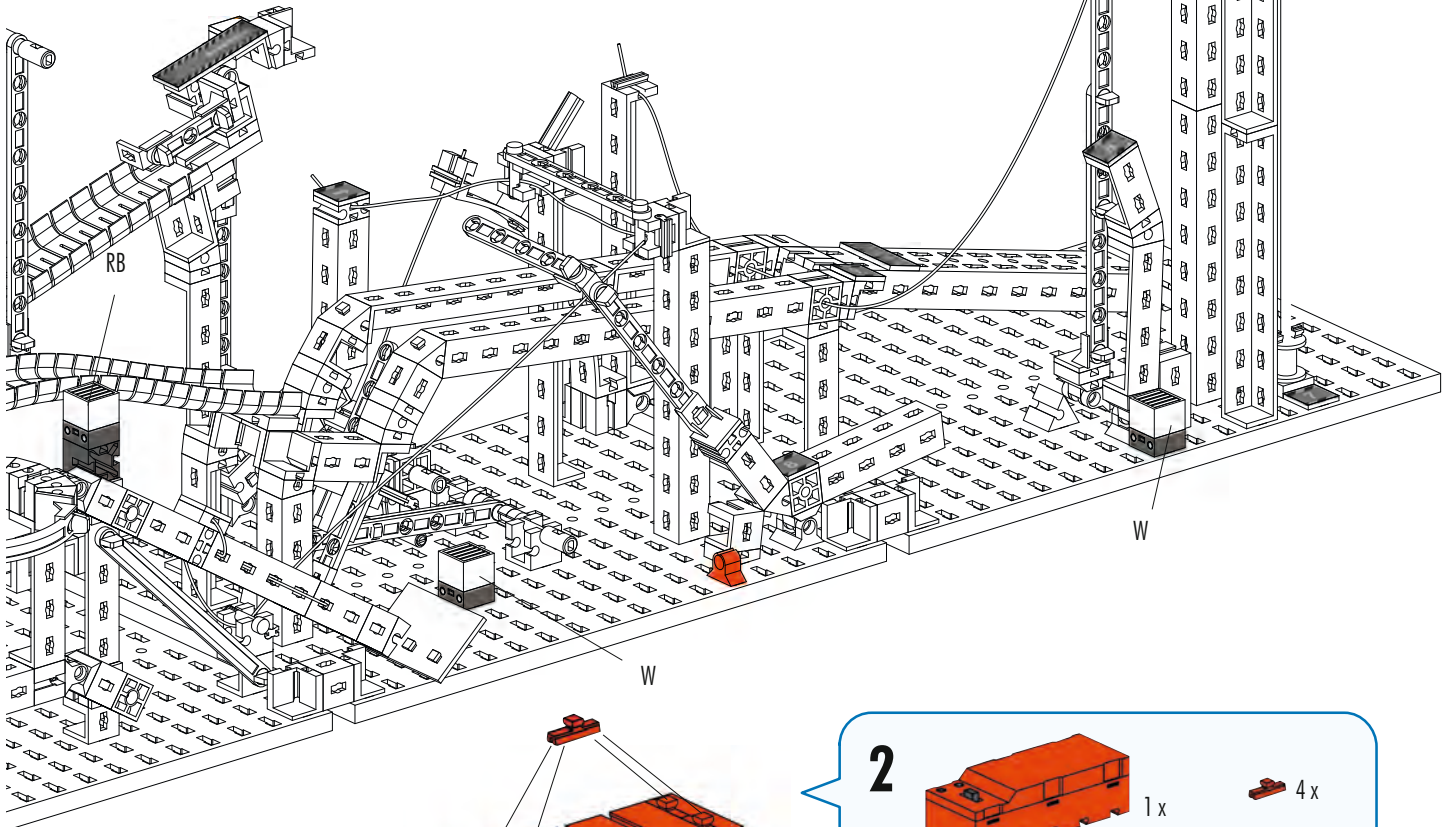

**2**

- 1x (Red 1x4 Technic brick)
- 4x (Red 1x2 Technic brick)

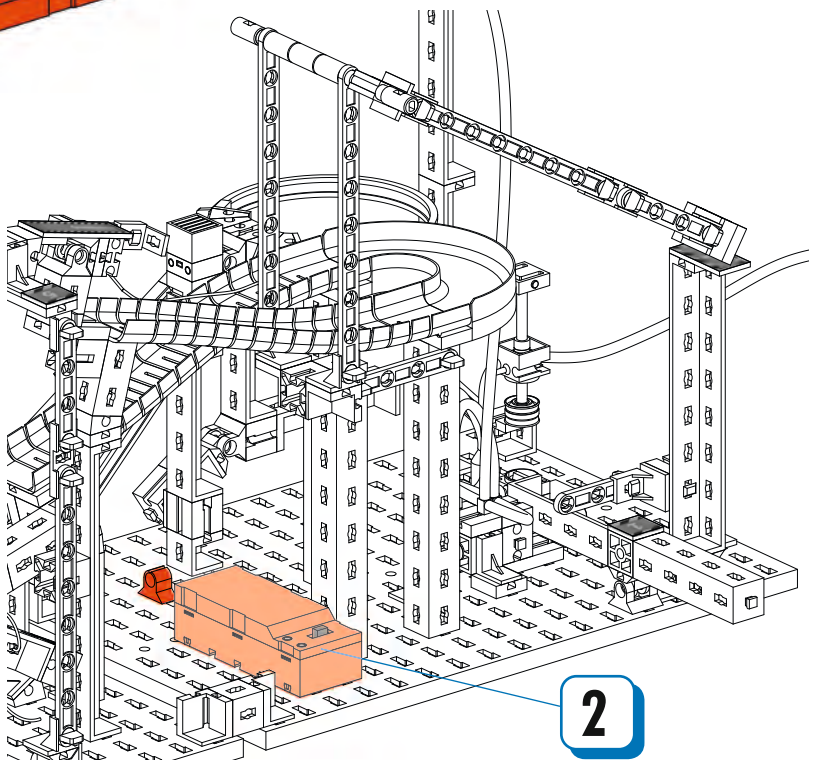

**3**

- 1x (Red 1x2 Technic brick)







**Parcours 2**  
**Obstacle course 2**  
**Parcours 2**

**Parcours 2**  
**Pista de recorrido 2**  
**Circuito 2**

**Circuito 2**  
**Маршрут 2**  
**滚珠弯道 2**

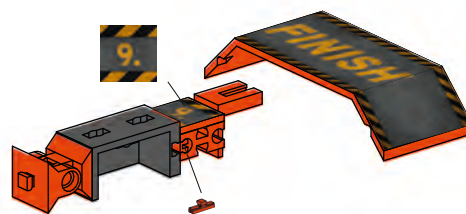
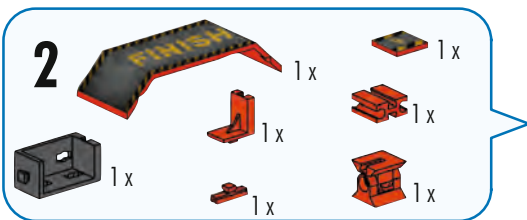
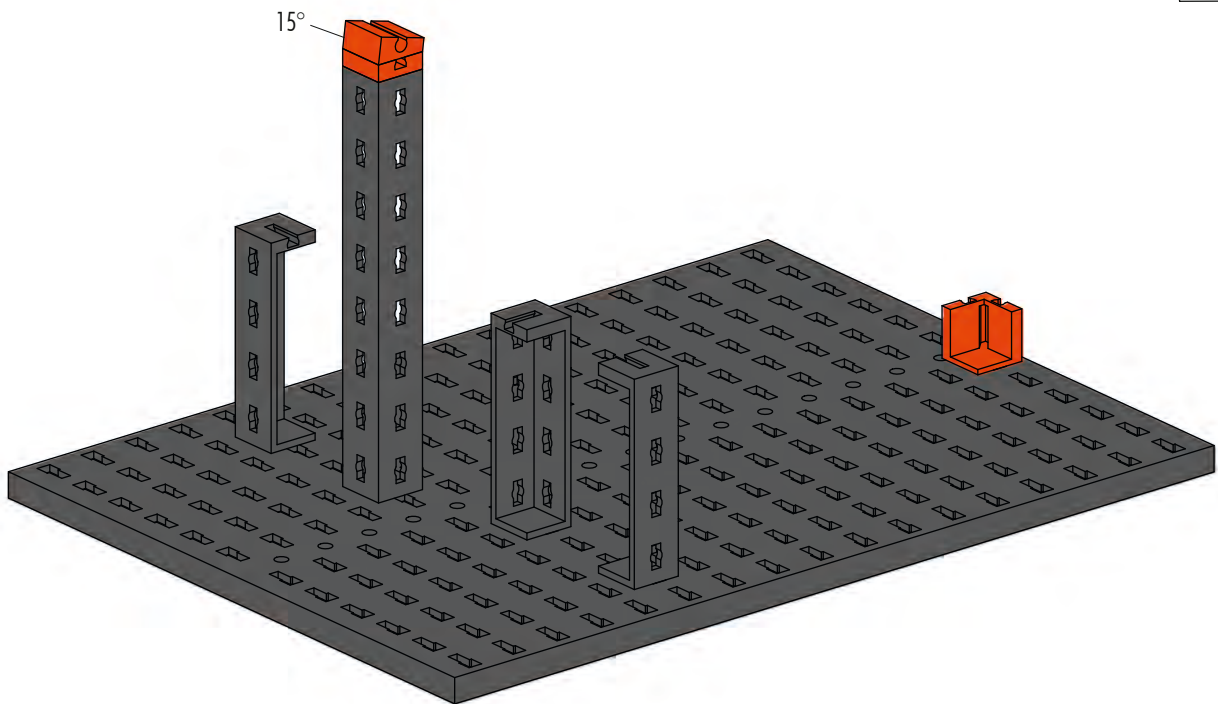
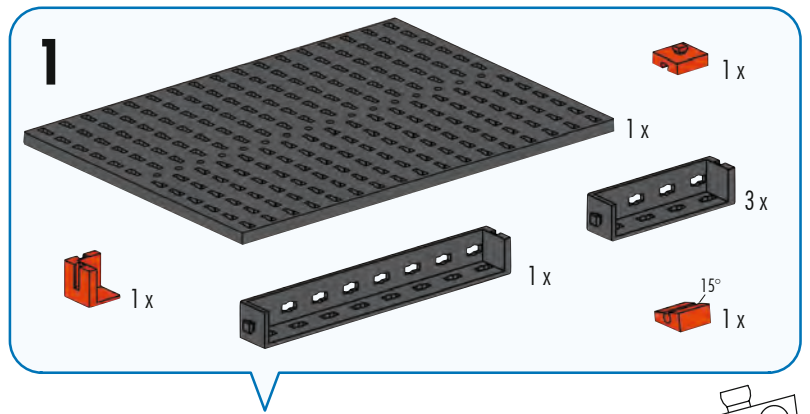

3

- 1 x [Long grey Technic beam]
- 2 x [Grey Technic connector]
- 2 x [Grey Technic pin]
- 1 x [Grey Technic axle]
- 1 x [Orange Technic 60° wedge]
- 1 x [Grey Technic 45° wedge]
- 1 x [Grey Technic 7.5° wedge]
- 3 x [Orange Technic 7.5° wedge]

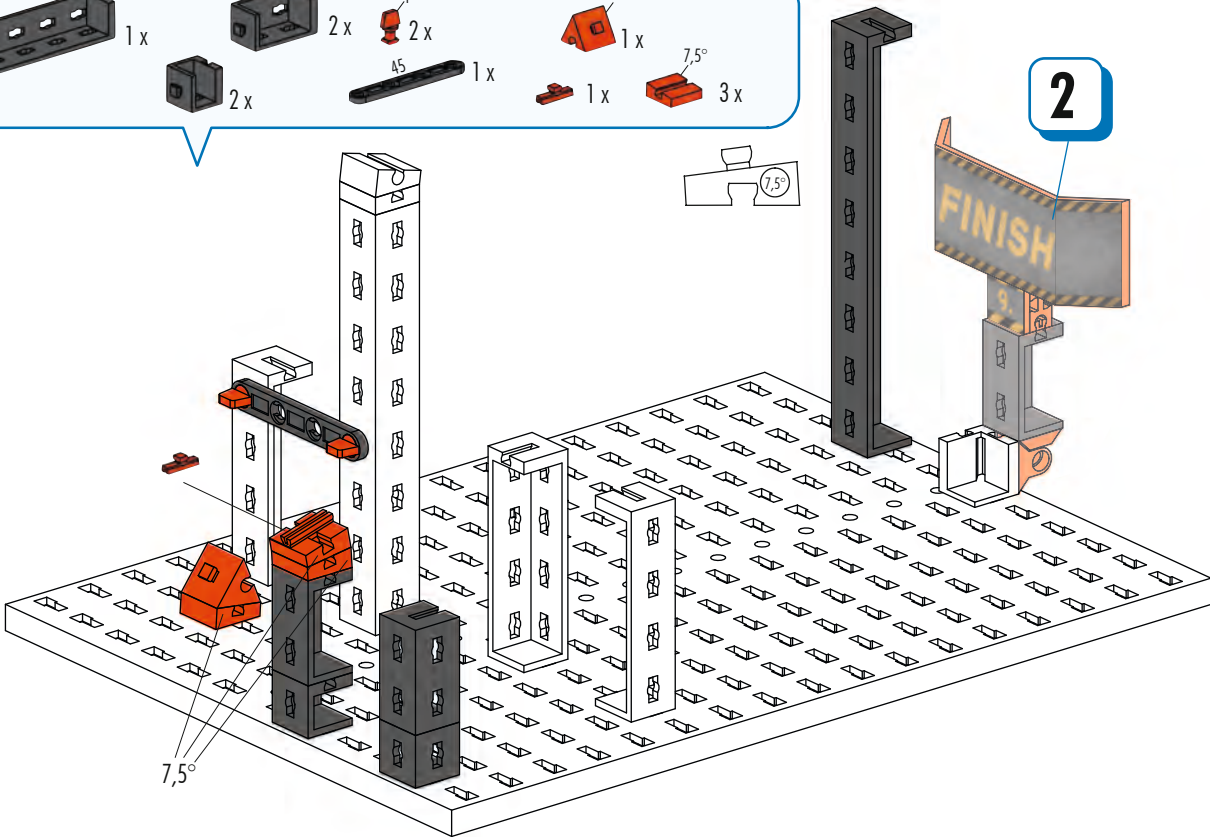

4

- 3 x [Long grey Technic beam]
- 1 x [Long orange Technic beam]
- 1 x [Orange Technic 1x3 beam]
- 2 x [Orange Technic connector]
- 1 x [Orange Technic pin]
- 1 x [Grey Technic pin]
- 4 x [Orange Technic L-shaped connector]

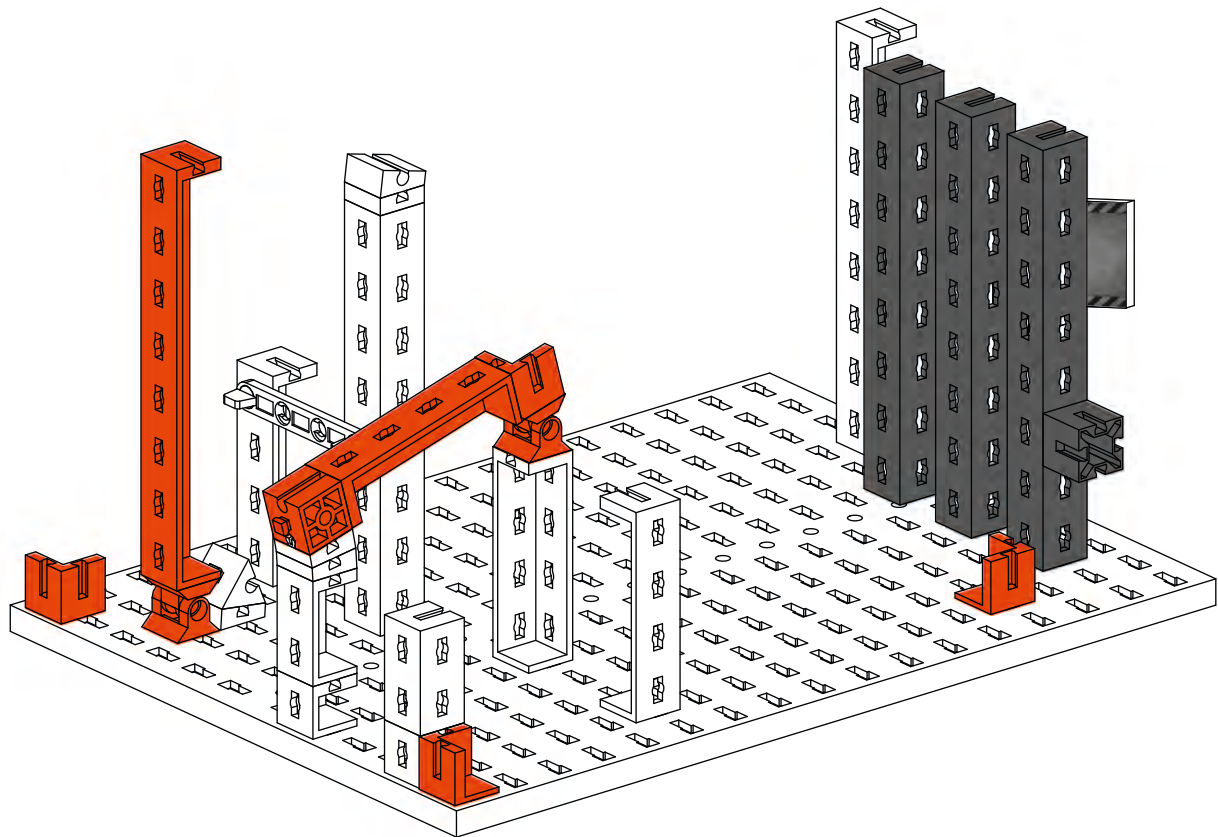

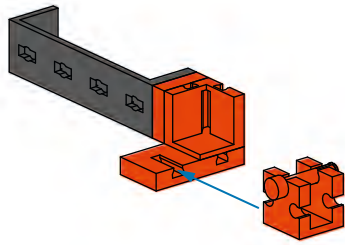

**5**

- 1x grey Technic beam (1x5)
- 1x orange Technic pin
- 1x orange Technic bush
- 1x orange Technic axle
- 1x orange Technic axle pin

**6**

- 1x orange Technic beam (1x11)
- 1x orange Technic beam (1x5)
- 1x grey Technic bush
- 1x yellow Technic bush
- 1x orange Technic bush
- 1x grey Technic bush
- 1x orange Technic pin
- 2x grey Technic bush
- 2x orange Technic pin (7.5°)

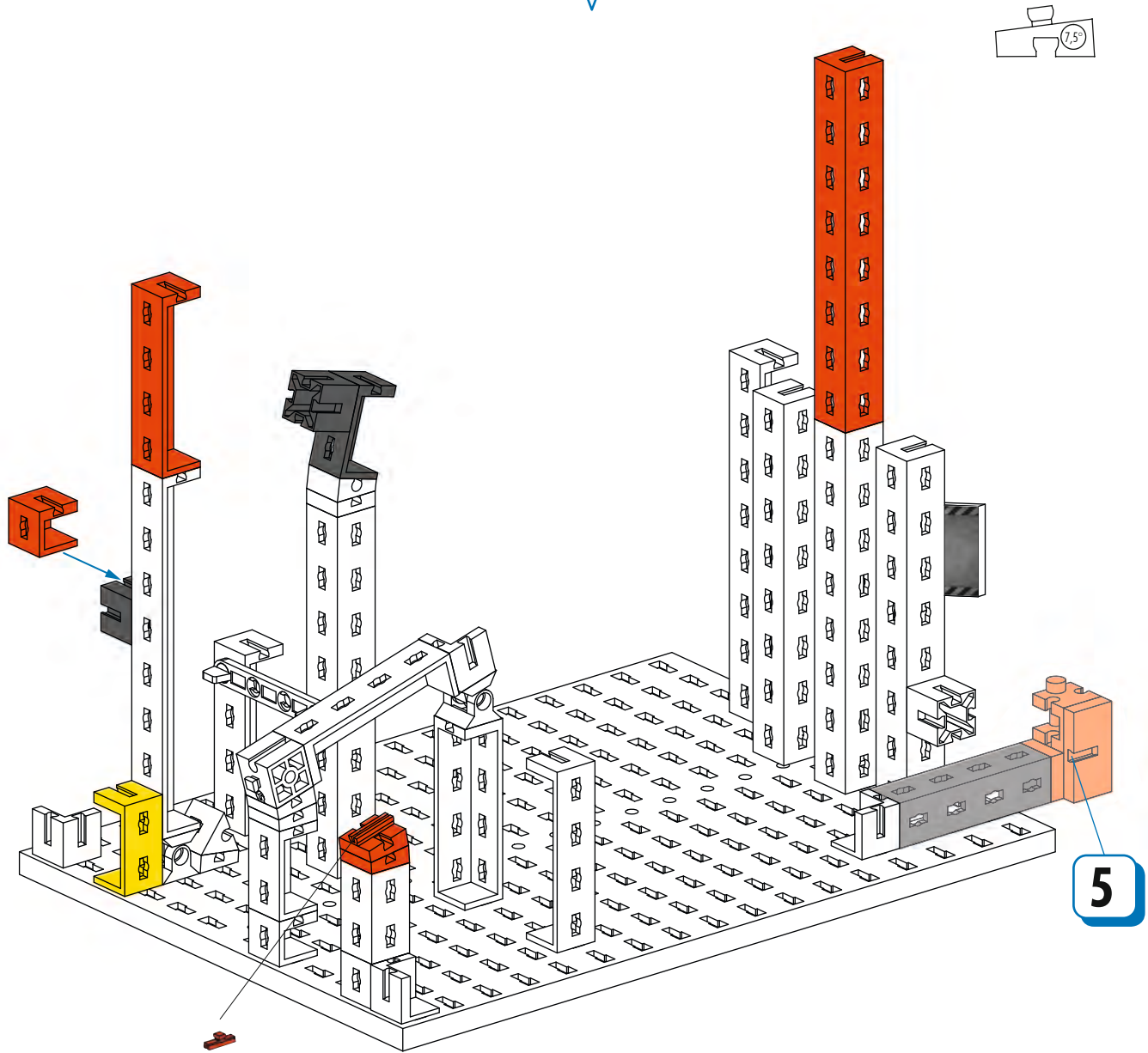



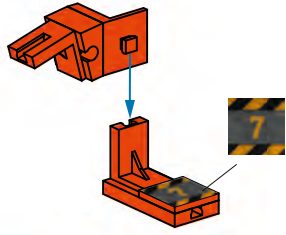

**7**

- Orange 1x3 Technic Beam: 1x
- Orange 1x2 Technic Beam: 2x
- Orange 1x2 Technic Beam with Pin Hole: 1x
- Orange 1x2 Technic Beam with Pin Hole and Groove: 1x
- Orange 15° Technic Beam: 1x

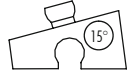

**8**

- Black 1x10 Technic Beam: 1x
- Orange 1x3 Technic Beam: 2x
- Orange 1x2 Technic Beam: 1x
- Green 1x30 Technic Beam: 1x
- Grey 1x2 Technic Beam with Pin Hole: 1x
- Orange 1x2 Technic Beam with Pin Hole: 1x
- Orange 1x2 Technic Beam with Pin Hole and Groove: 1x
- Orange 1x2 Technic Beam with Pin Hole and Groove: 1x
- Orange 1x2 Technic Beam with Pin Hole: 1x
- Red 1x2 Technic Pin: 2x

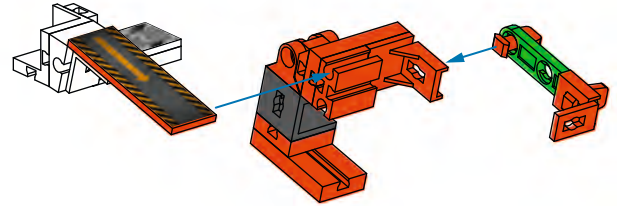

**9**

- Black 1x10 Technic Beam: 1x
- Orange 1x3 Technic Beam: 1x
- Black 1x90 Technic Beam: 2x
- Black 1x2 Technic Beam with Pin Hole: 1x
- Red 1x2 Technic Pin: 2x
- Orange 1x2 Technic Beam: 1x
- Orange 1x2 Technic Beam with Pin Hole: 1x
- Orange 1x2 Technic Beam with Pin Hole and Groove: 1x
- Orange 1x2 Technic Beam with Pin Hole: 2x
- Orange 1x2 Technic Beam with Pin Hole and Groove: 1x
- Orange 15° Technic Beam: 2x

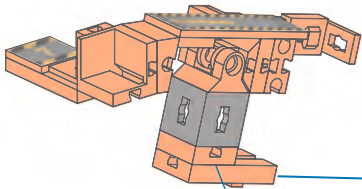
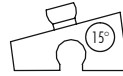

**8**

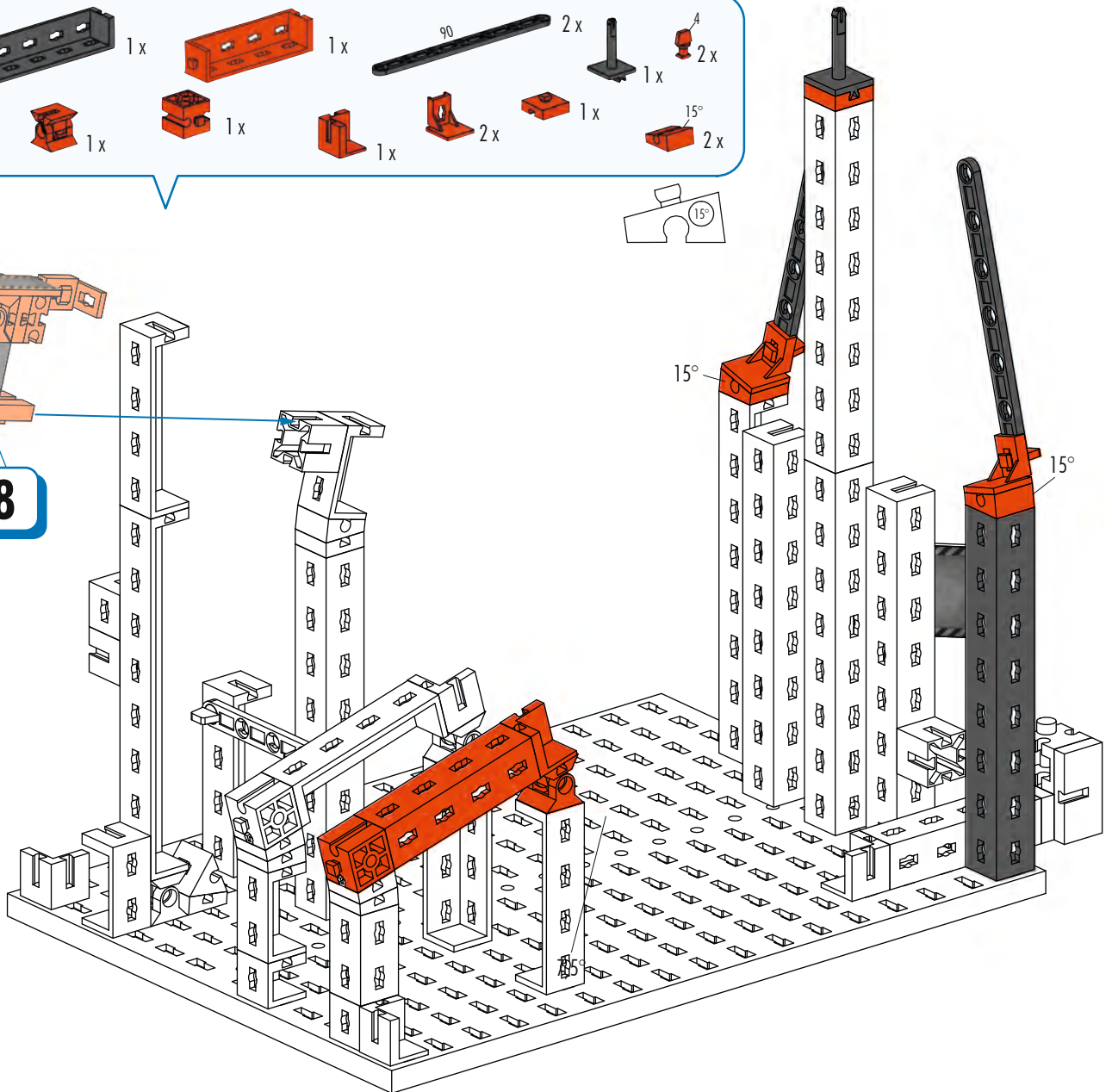



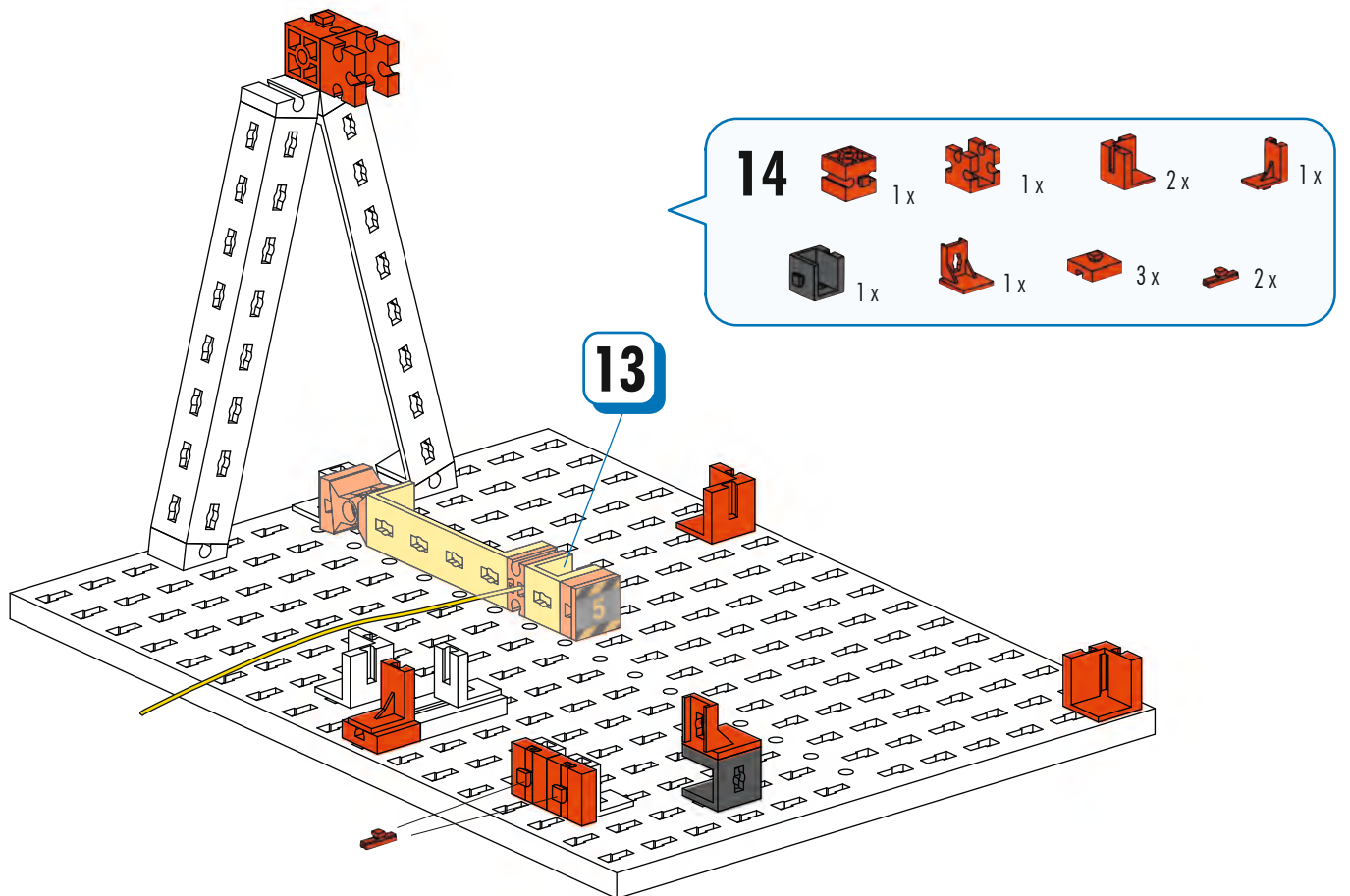
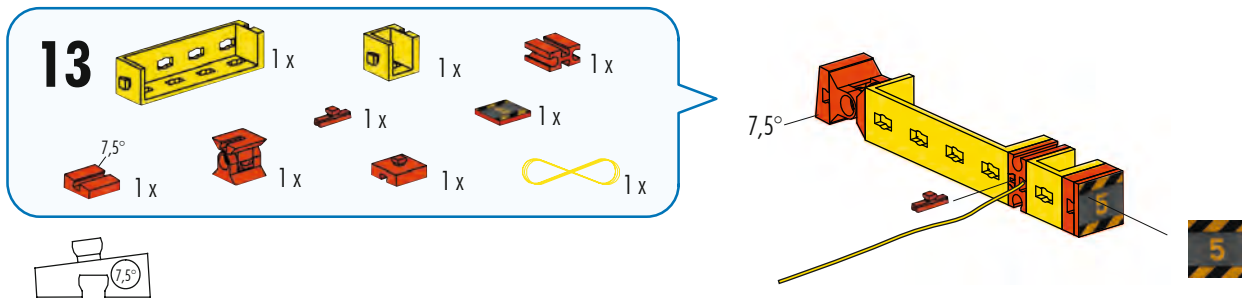
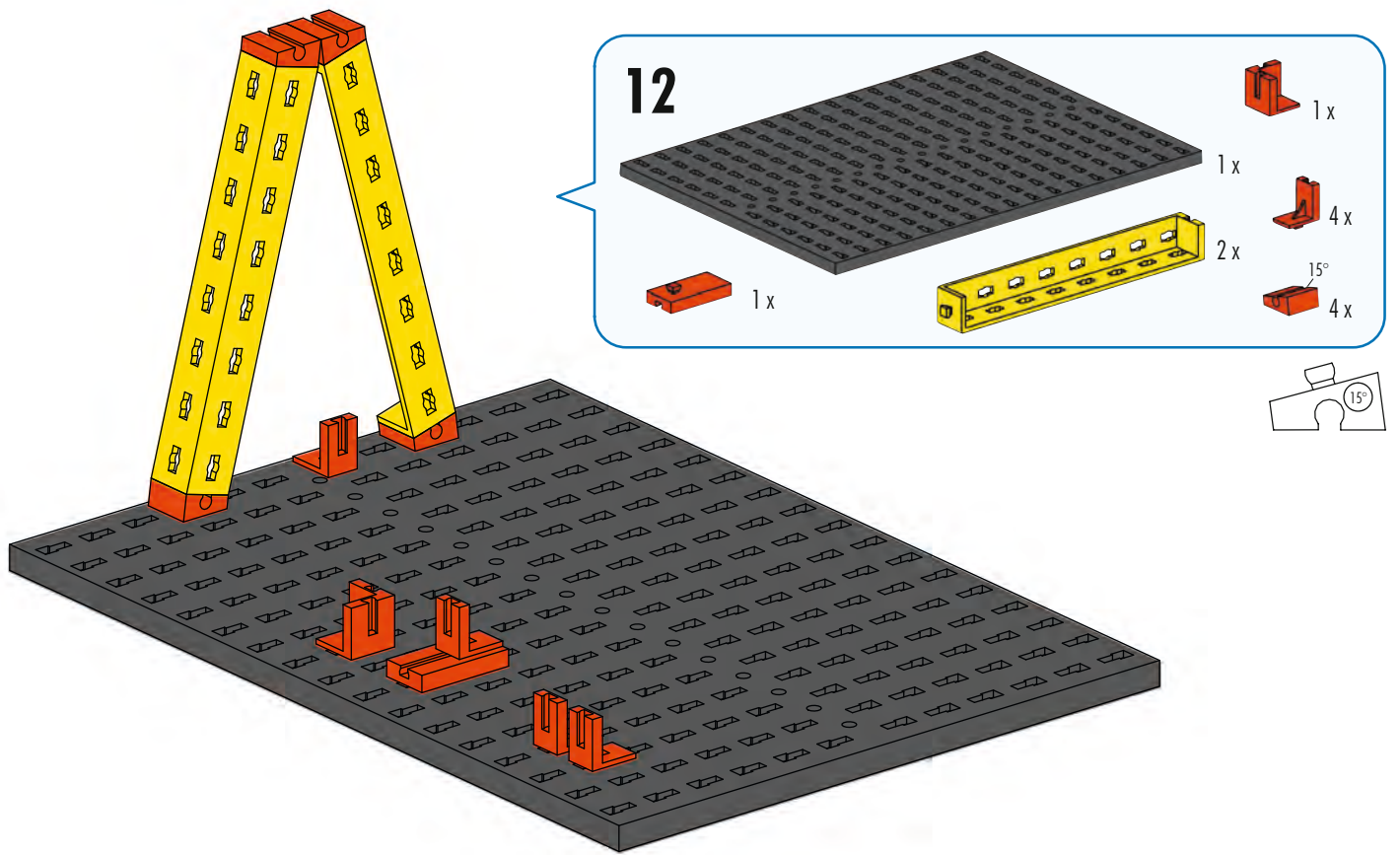



15

- 60 1x
- 2x
- 2x
- 1x
- 1x
- 1x

60 mm

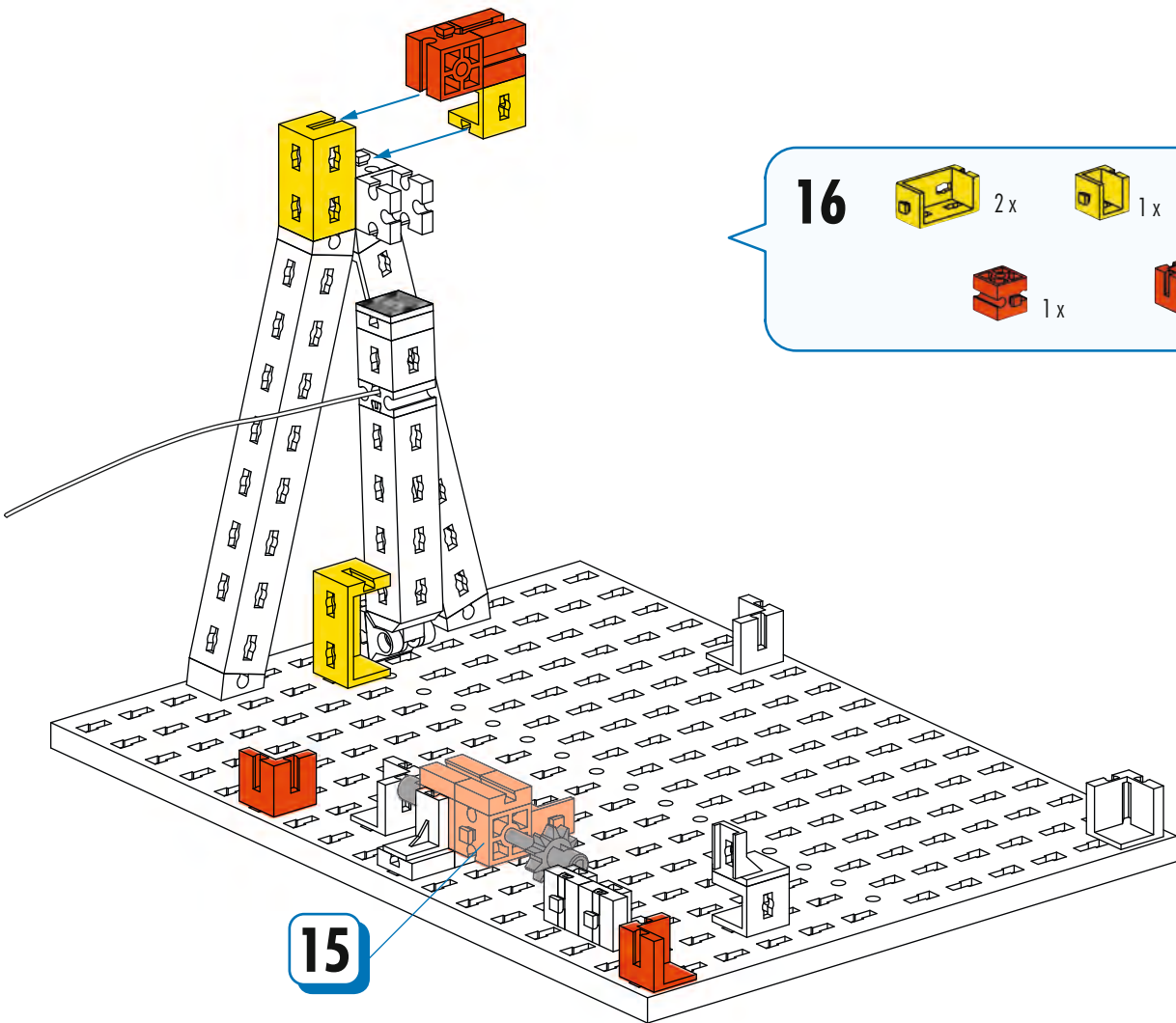
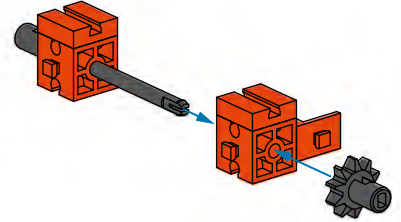

16

- 2x
- 1x
- 1x
- 1x
- 2x

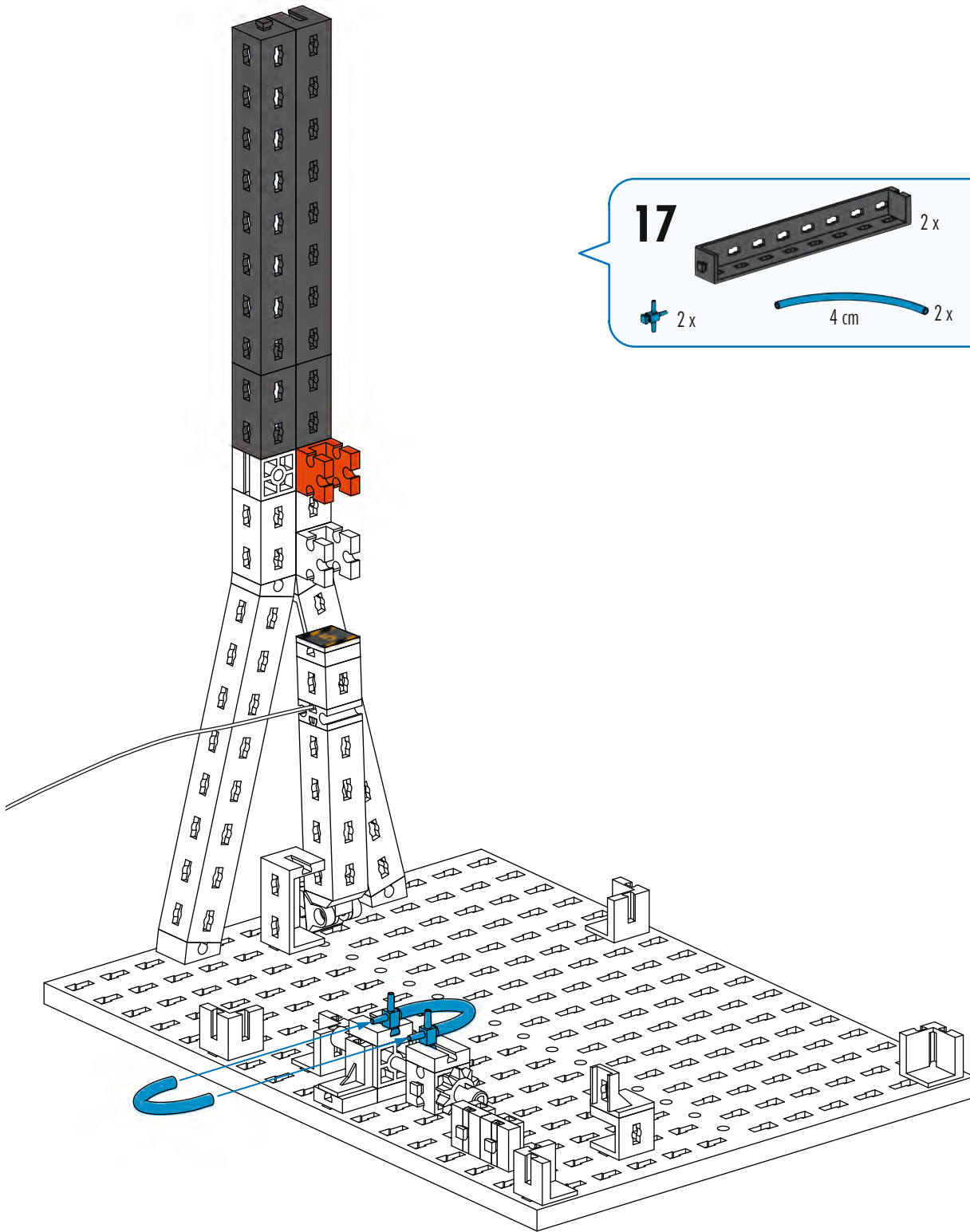

**17**

- Dark grey Technic beam (1x7) 2 x
- Dark grey Technic connector (1x2) 2 x
- Blue Technic pin 2 x
- Blue curved Technic beam (4 cm) 2 x
- Orange Technic connector (1x2) 1 x

**18**

- Orange Technic plate (1x10) 1 x
- Orange Technic connector (1x2) 1 x
- Orange Technic connector (1x2) 1 x
- Orange Technic connector (1x2) 1 x
- Orange Technic connector (1x2) 1 x
- Orange Technic connector (1x2) 1 x
- Orange Technic connector (1x2) 1 x
- Orange Technic connector (1x2) 1 x

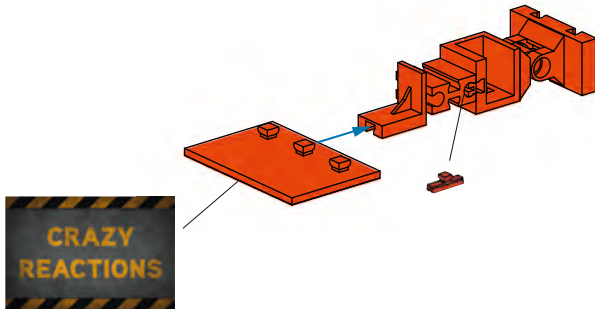

19

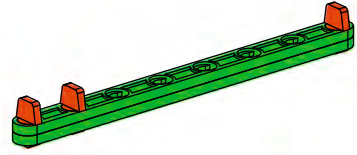
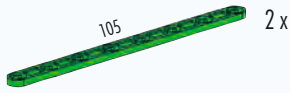

19

20

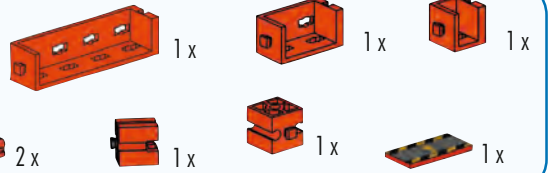





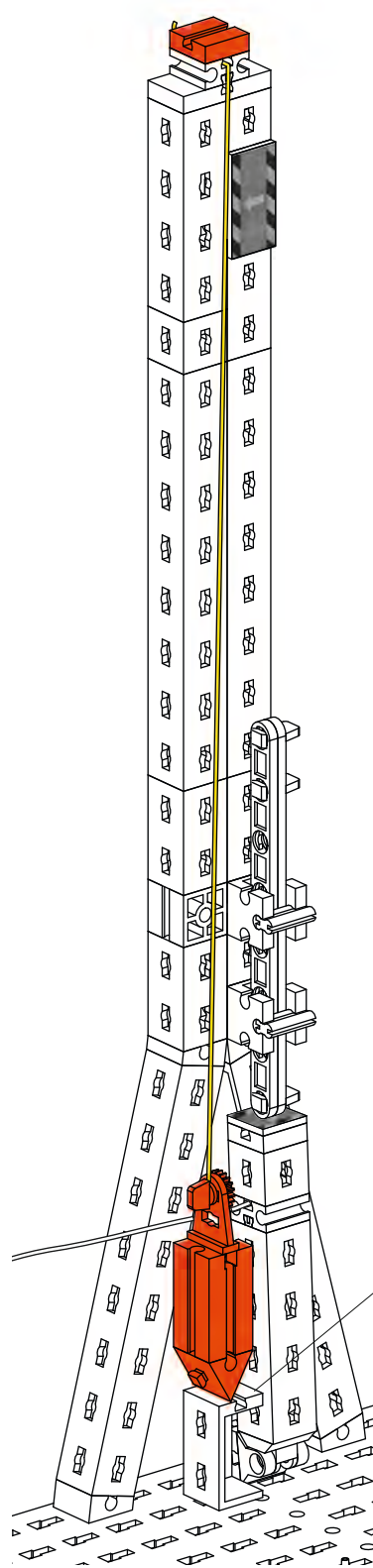
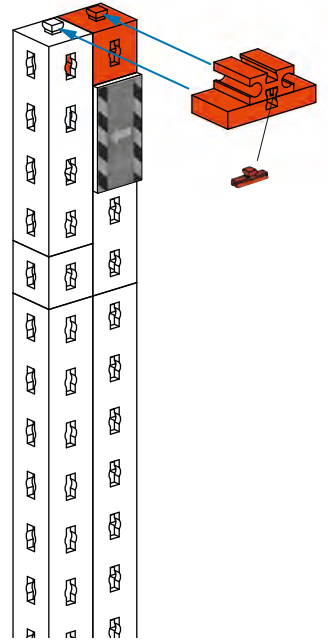

18



**21**  1x  1x  1x  1x



**22**  1x  1x  1x  1x  1x  1x

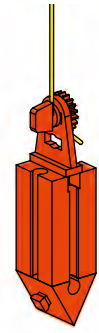

**23**  1x

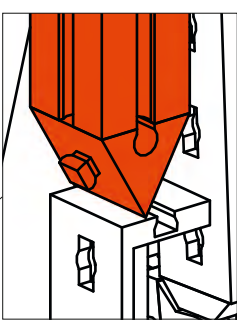

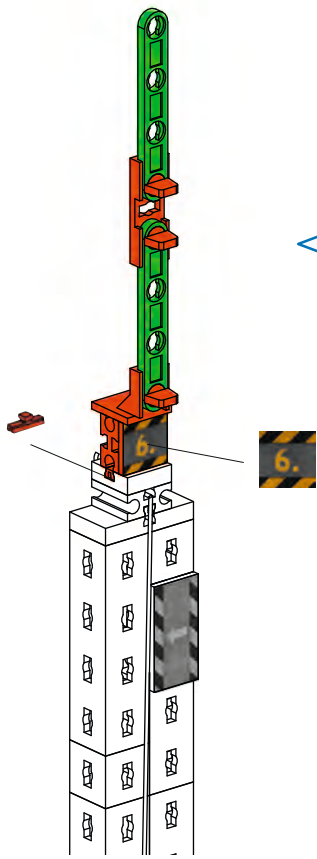

- 24**
- 1x (orange 1x2 Technic brick)
  - 1x (orange 1x2 Technic brick with hole)
  - 1x (orange 1x2 Technic brick with hole)
  - 1x (black 1x2 Technic brick)
  - 2x (green 1x45 Technic axle)
  - 1x (orange 1x2 Technic brick)
  - 3x (red 1x4 Technic pin)

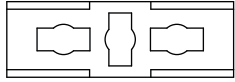

- 25**
- 2x (black 1x2 Technic brick)
  - 1x (orange 1x2 Technic brick)
  - 1x (black 1x2 Technic brick)
  - 1x (red 1x2 Technic brick)
  - 1x (blue infinity-shaped Technic connector)

**11**

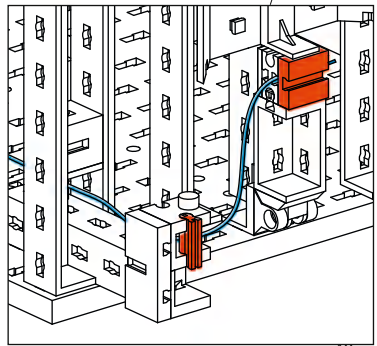
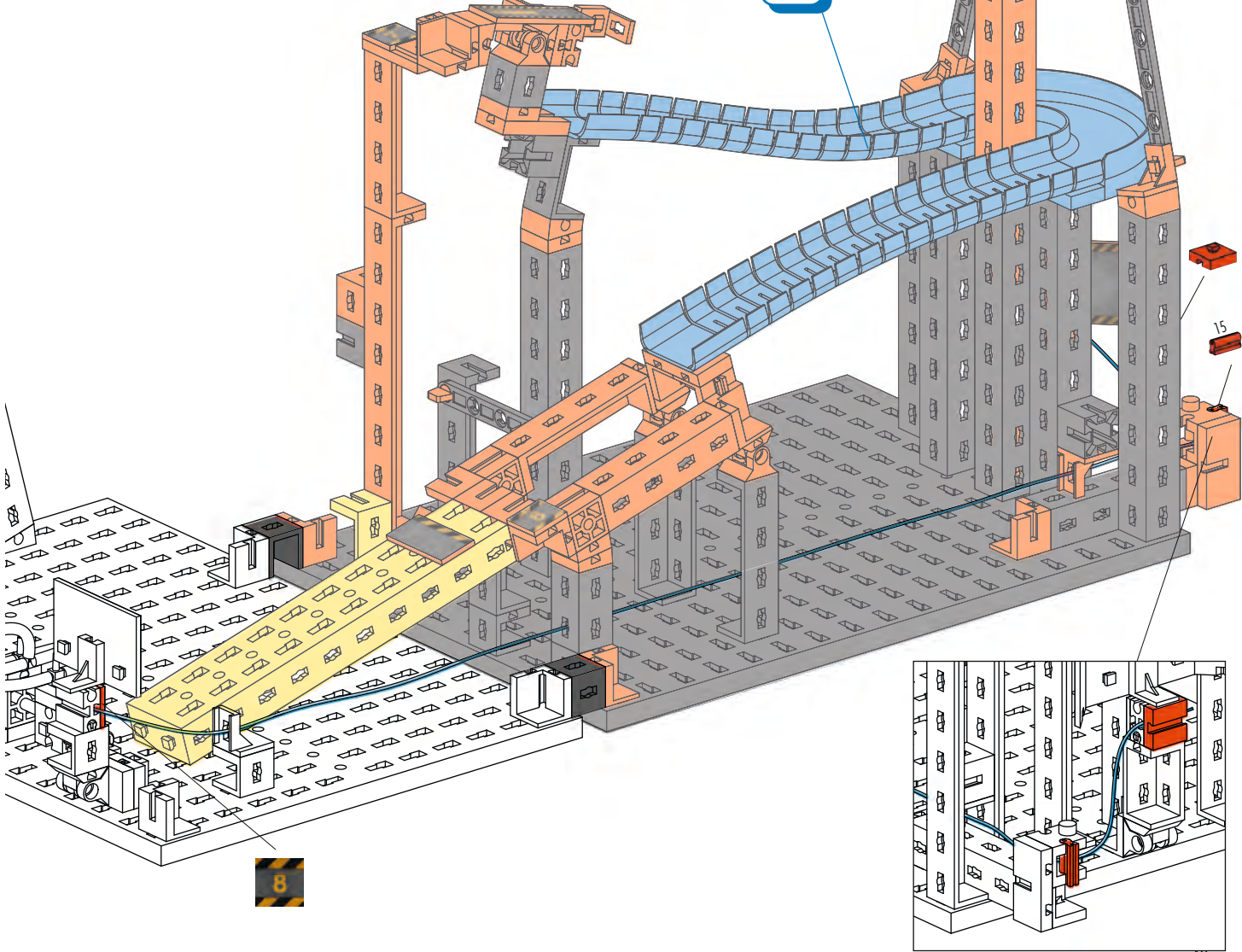





28

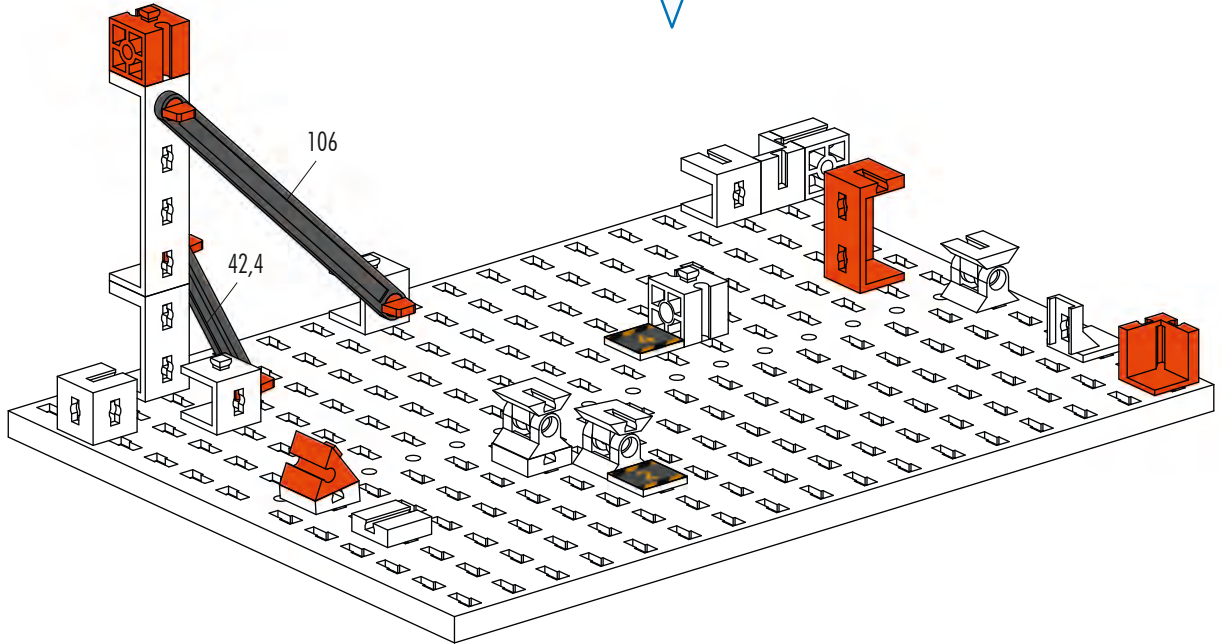
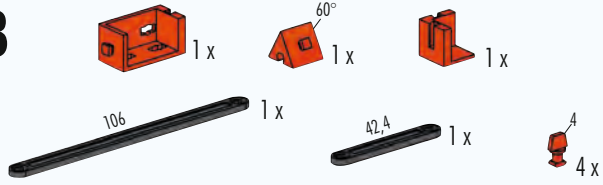

29

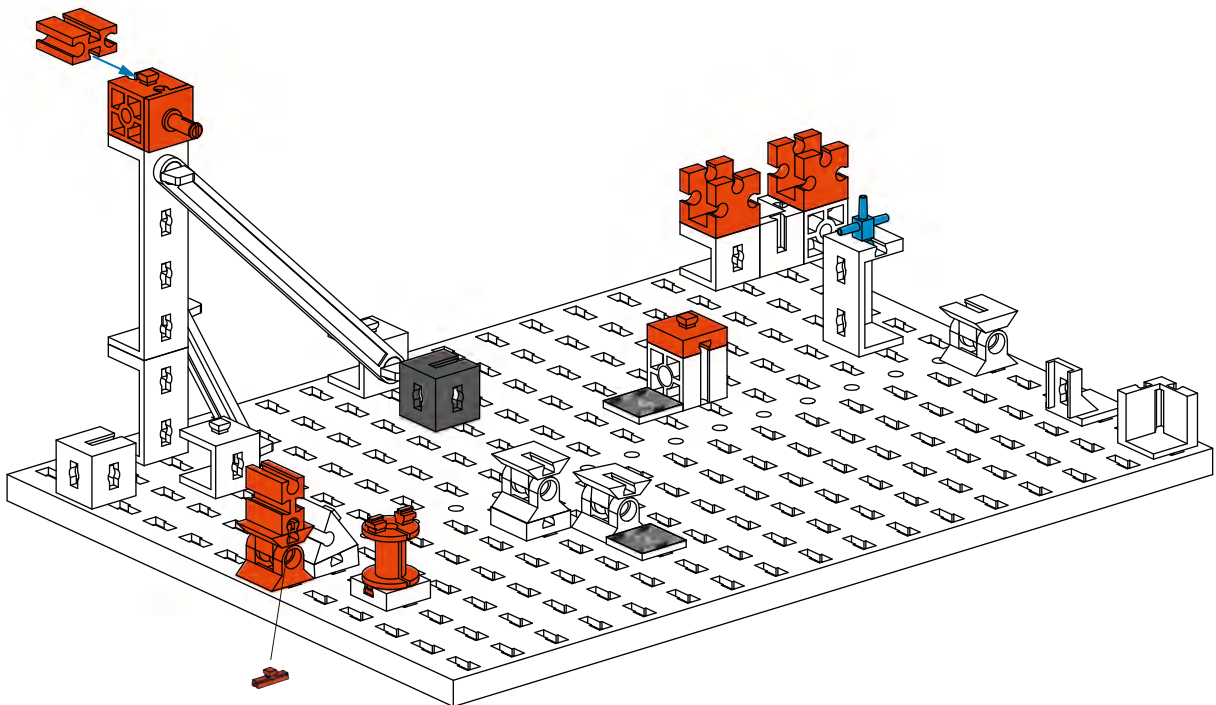
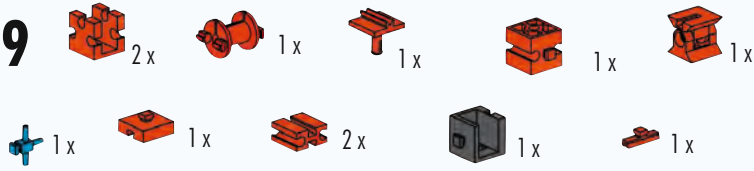

30

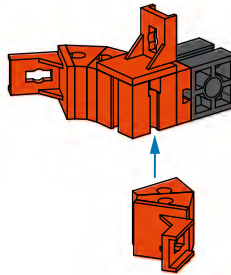
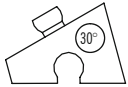
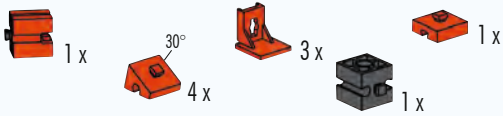

Große Bohrung  
 Large drilling  
 Alésage large  
 Grote boring  
 Perforación grande  
 Orificio grande  
 Grande foro  
 Большое отверстие  
 大孔

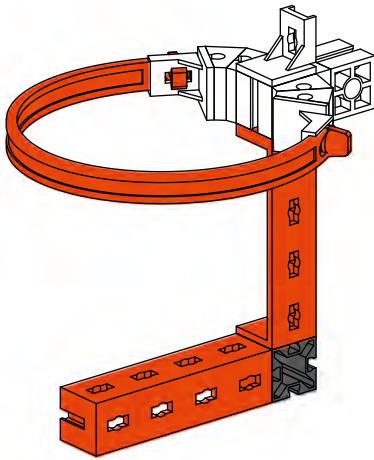

31

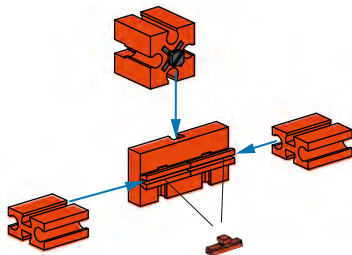
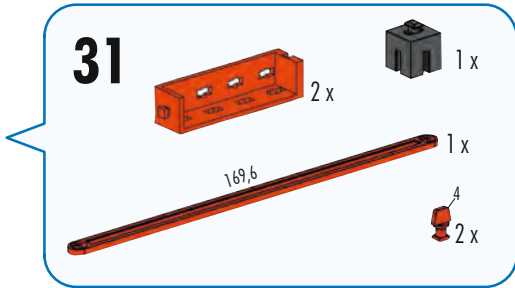
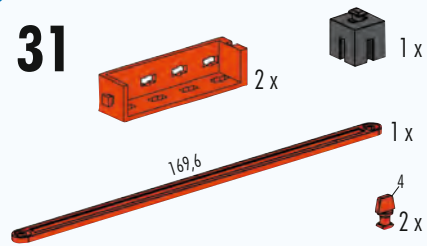

32

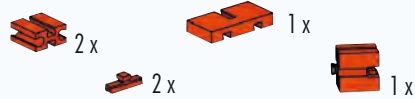

33



4 x



60°

4 x

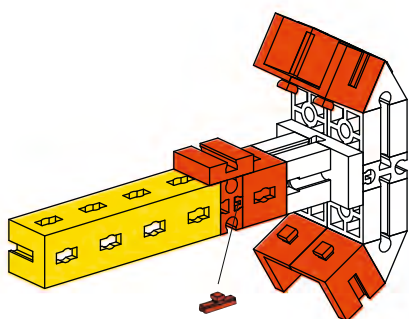
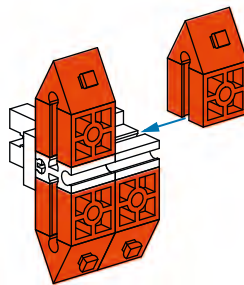

34

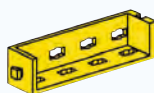

1 x



1 x



4 x



1 x



1 x



1 x

35



120

1 x



A

1 x

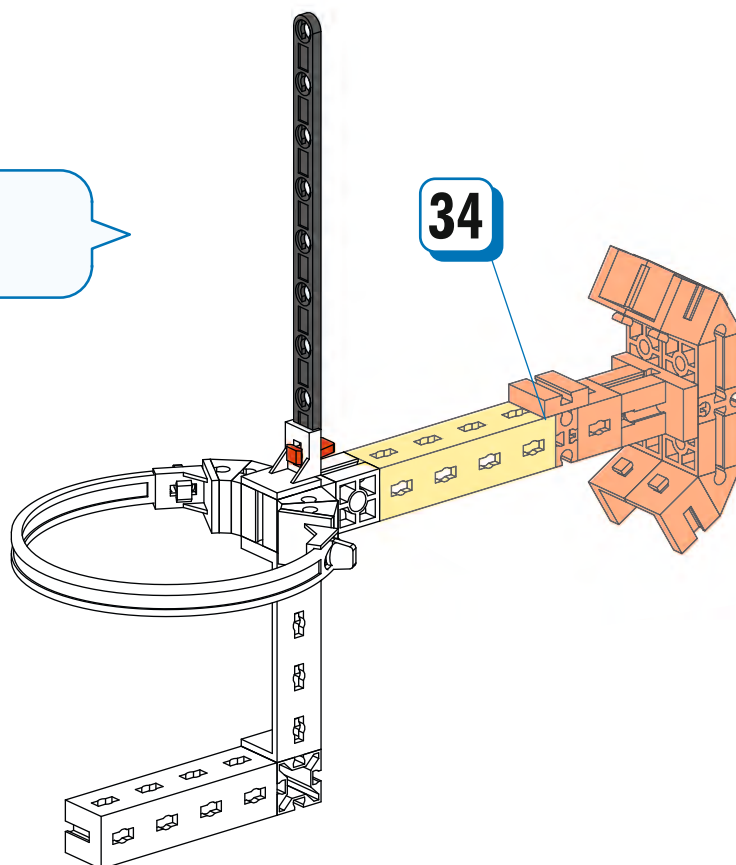



36

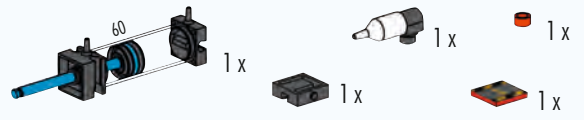

35

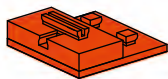
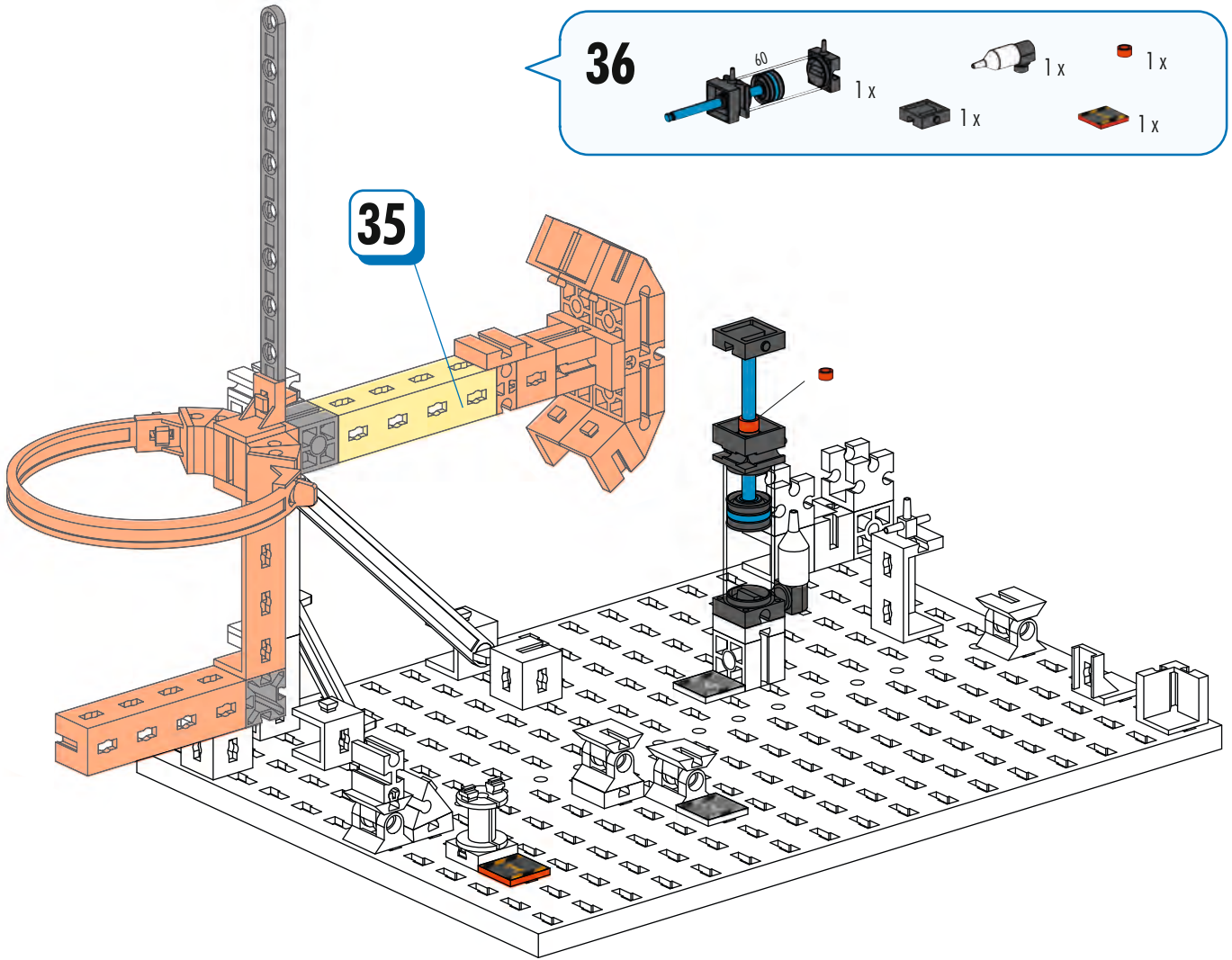

37



**38** 15 1x 105 2x 1x 1x 1x 1x 6x

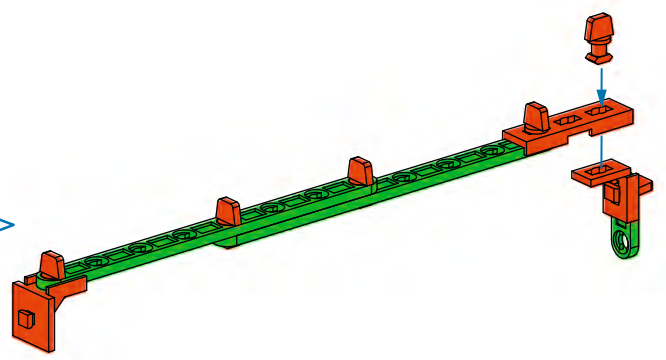
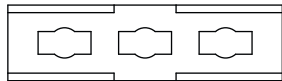

**39** 1x 7,5° 1x 8 cm 1x

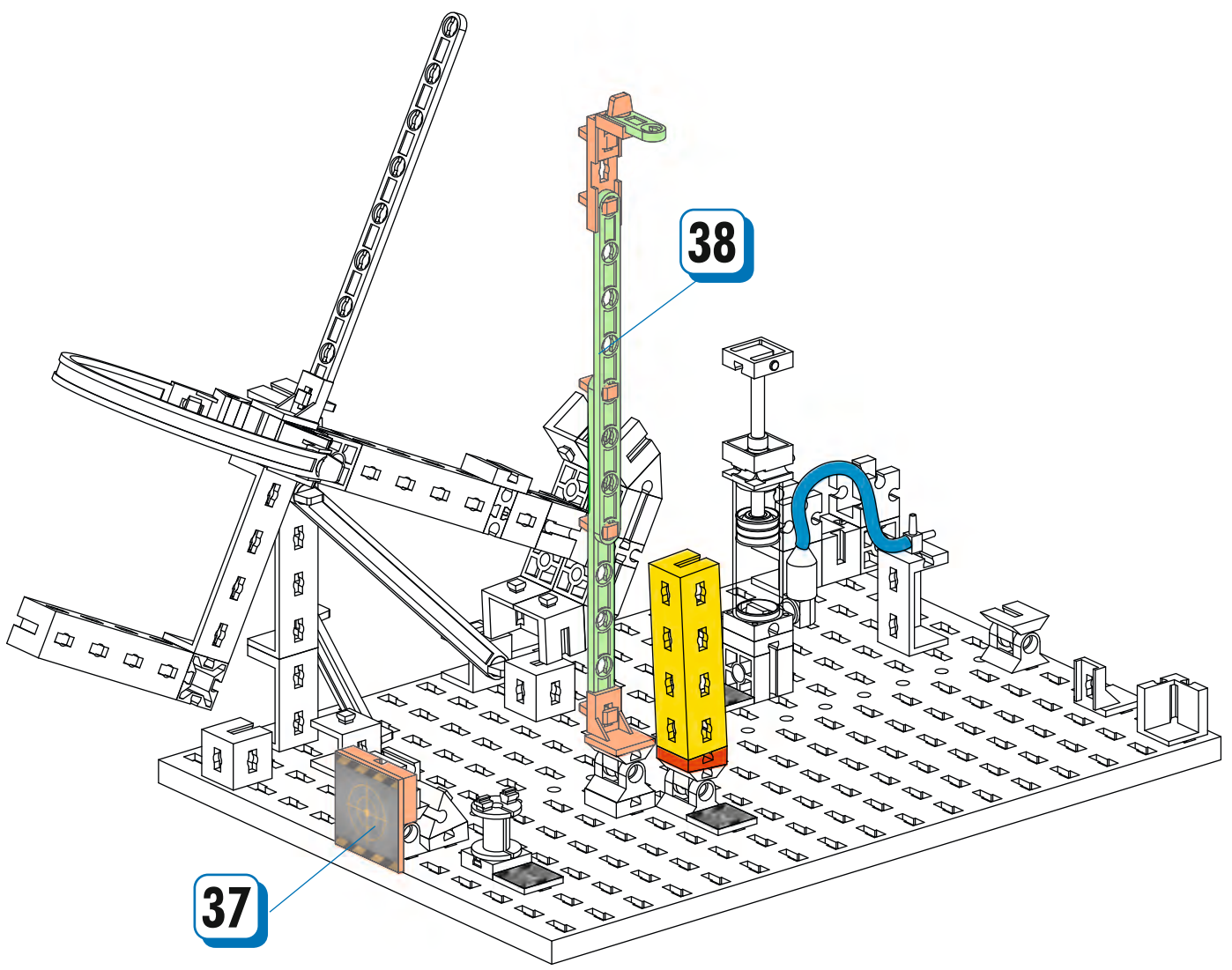
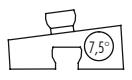



41

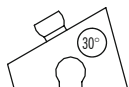
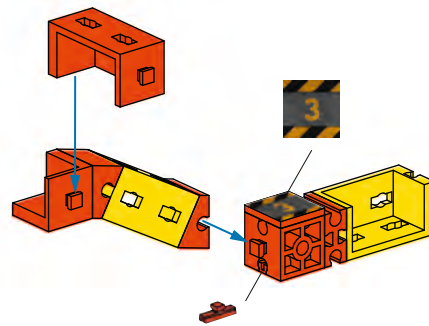
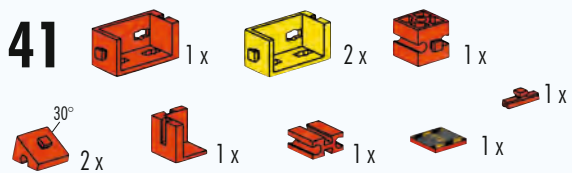

42

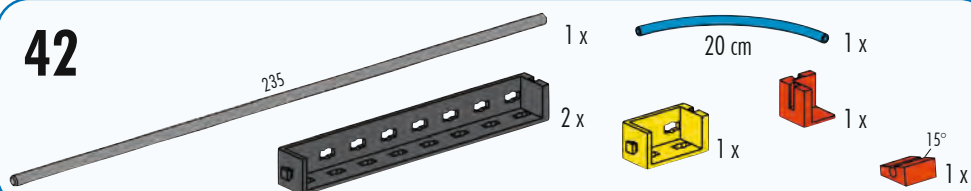

235 mm

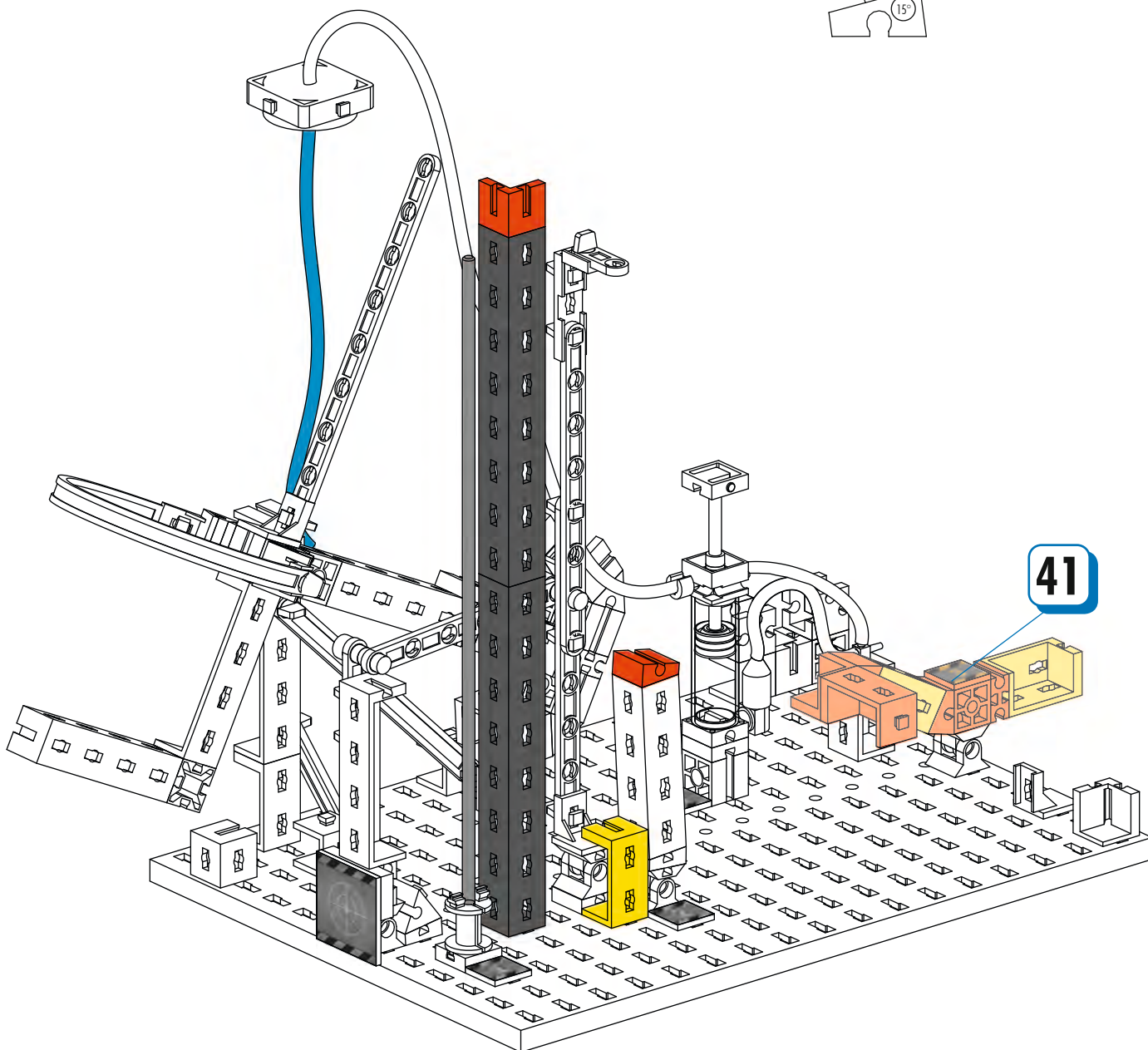

41



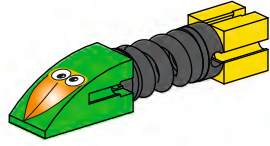

43



1x



1x



1x

44

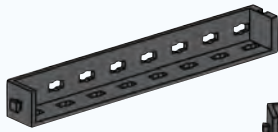

2x



1x



1x



1x



1x



1x



1x

7,5°



7,5°

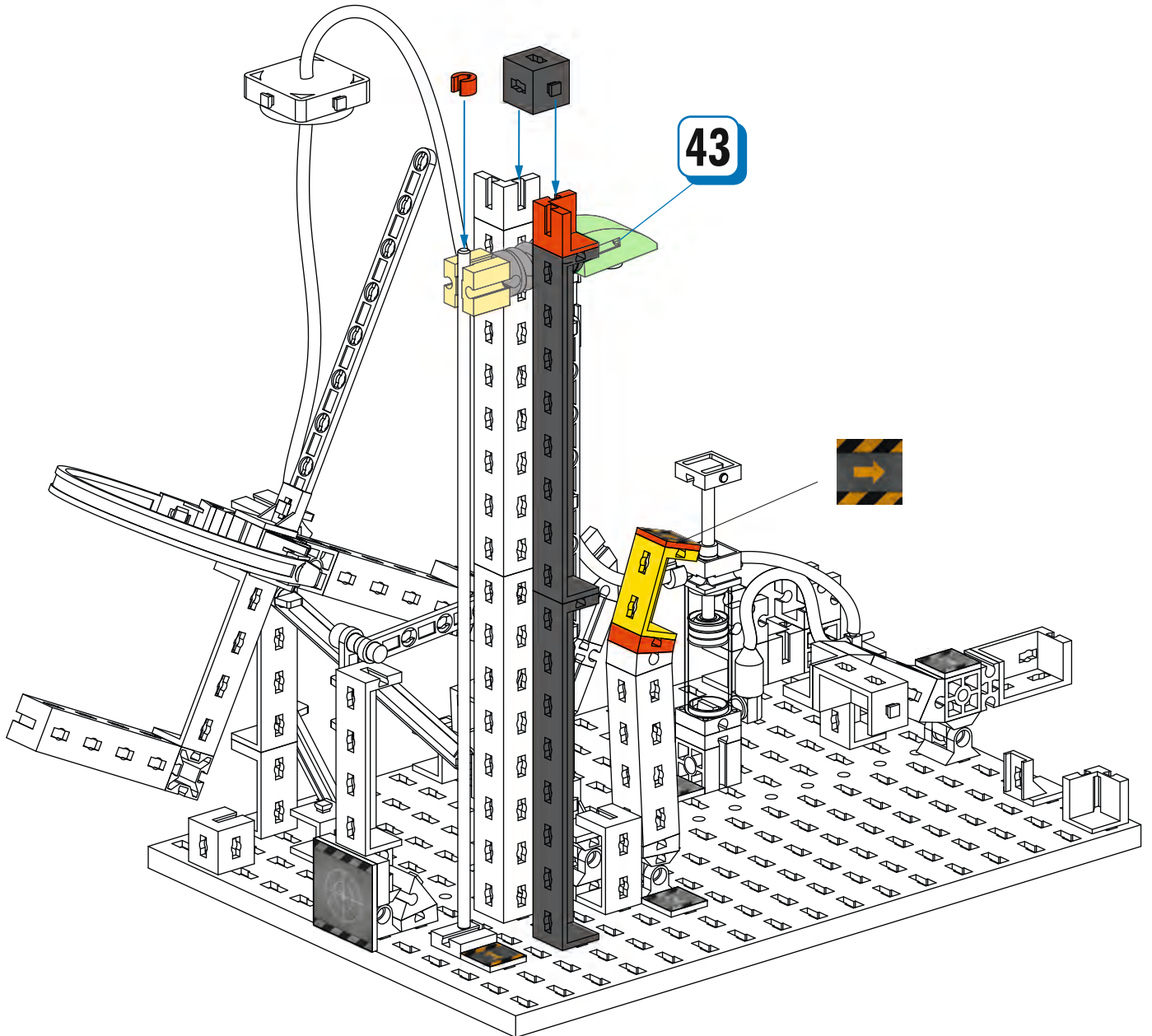

45



1 x



1 x

15

2 x



1 x



8 cm

1 x



30 cm

1 x

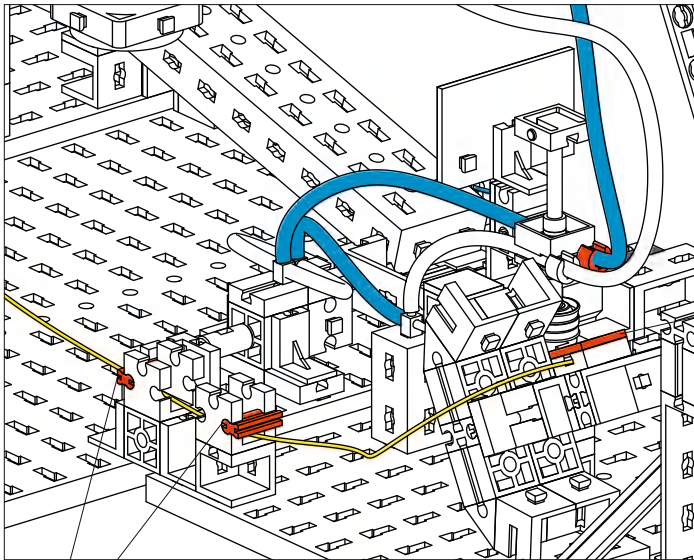
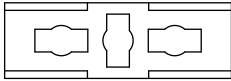

25



15

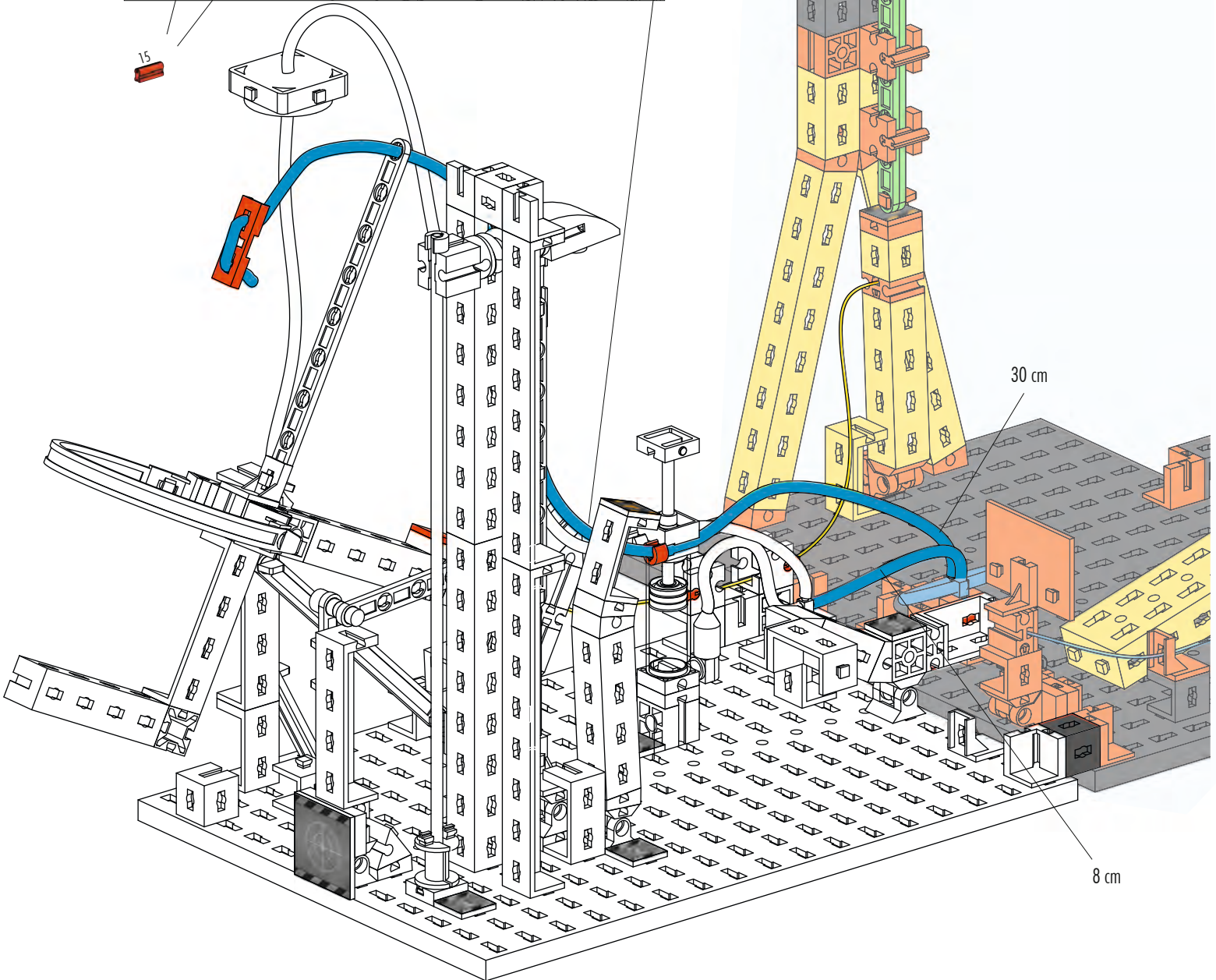
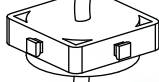

30 cm

8 cm

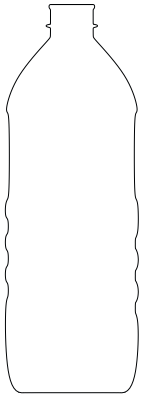

46



1 x



1 x



- Tipps und Tricks zur Inbetriebnahme der Modelle
- Tips and tricks for commissioning the models
- Conseils et astuces pour la mise en service des modèles
- Tips en trucs voor het in opdracht geven van de modellen
- Consejos y trucos para encargar las maquetas
- Dicas e truques para o comissionamento dos modelos
- Consigli e suggerimenti per la messa in servizio dei modelli
- Советы и рекомендации по вводу моделей в эксплуатацию
- 调调试模型的技巧+诀窍

- Kombiniere deine Modelle
- Combine your models
- Combine tes modèles
- Combineer je modellen
- Combine sus modelos
- Combine seus modelos
- Combinare i modelli
- Объедините свои модели
- 结合你的模型



<https://www.fischertechnik.de/crazyreactions-tutorials>







- 3**
- 2x [Grey Technic Pin]
  - 1x [Red Technic Pin]
  - 2x [Grey Technic Pin]
  - 1x [Red Technic Pin]
  - 1x [Red Technic Pin]
  - 1x [Red Technic Pin]
  - 1x [Red Technic Pin]
  - 1x [Red Technic Pin]

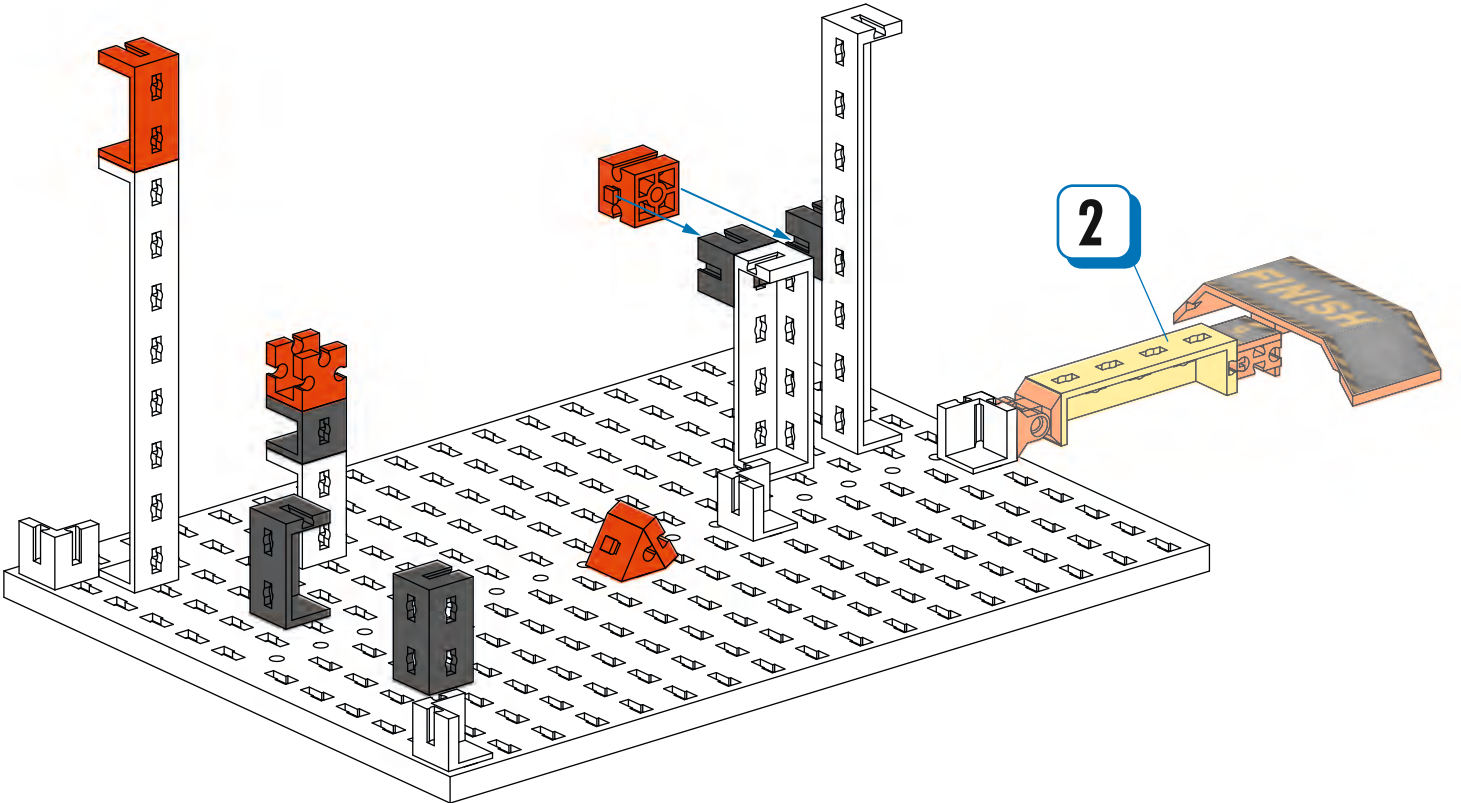

- 4**
- 1x [Grey Technic Beam 1x5]
  - 1x [Grey Technic Beam 1x3]
  - 1x [Grey Technic Pin]
  - 1x [Red Technic Pin]
  - 1x [Red Technic Pin]
  - 2x [Red Technic Pin]
  - 1x [Red Technic Pin]
  - 1x [Red Technic Pin]

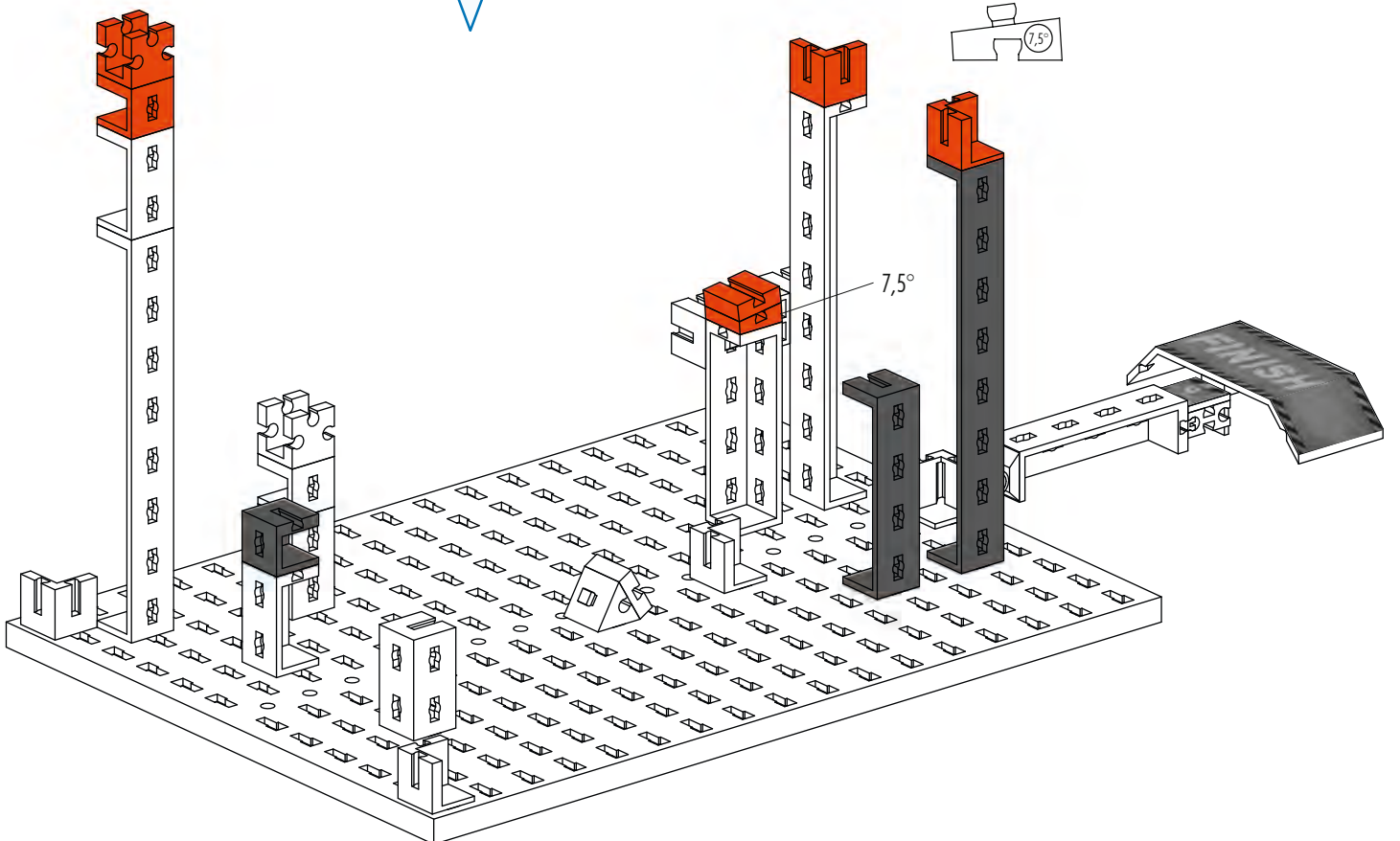



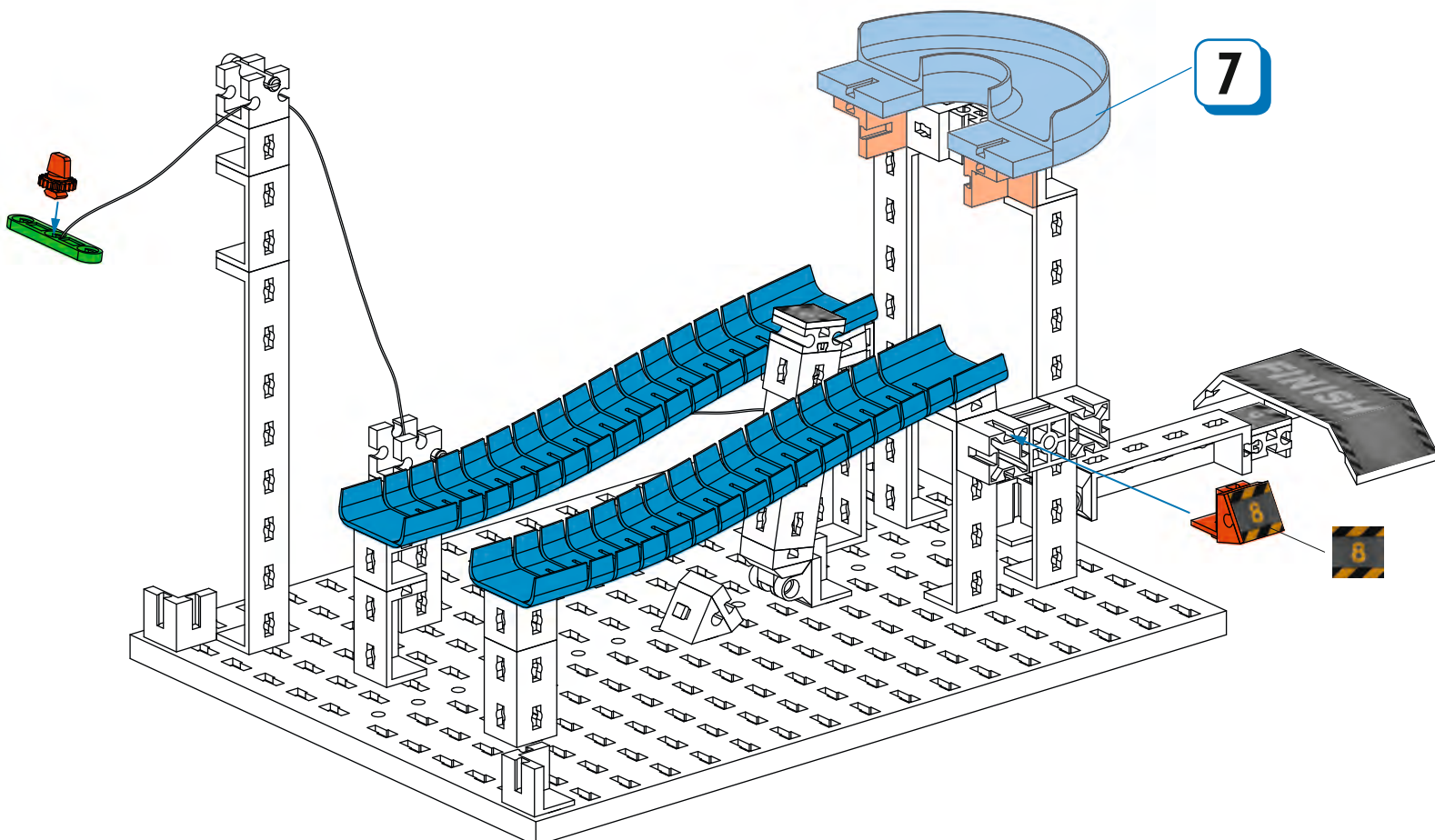
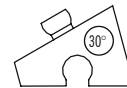
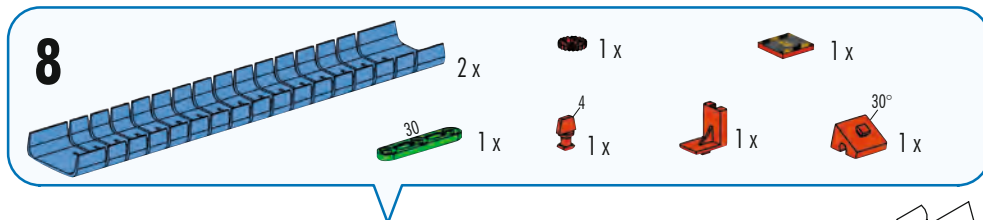
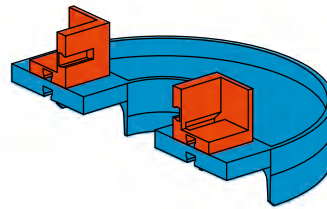
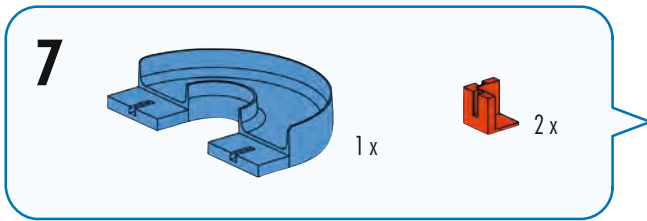

9

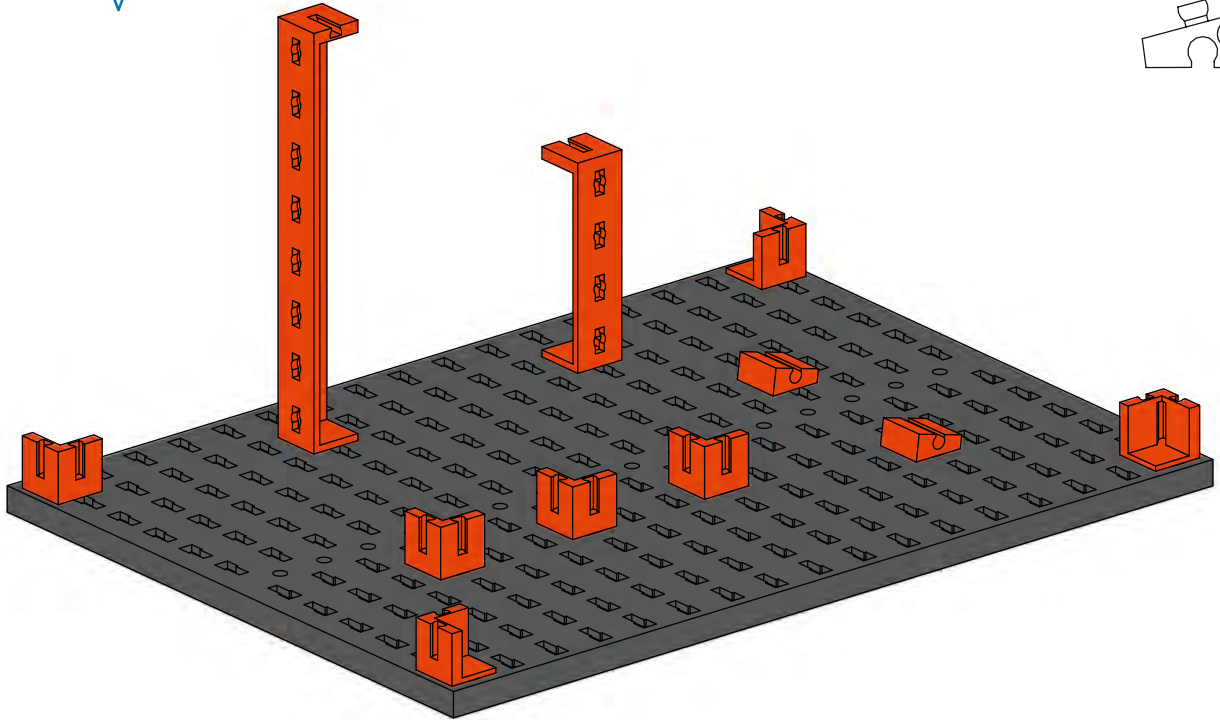
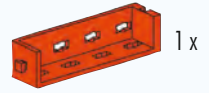
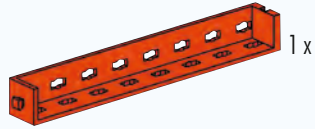
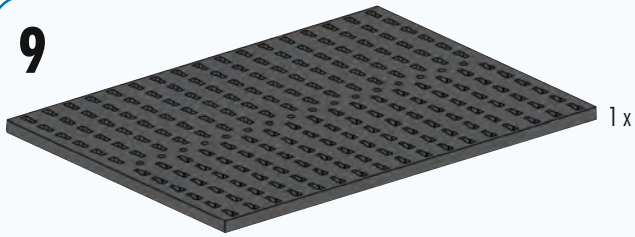

10

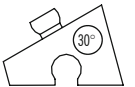
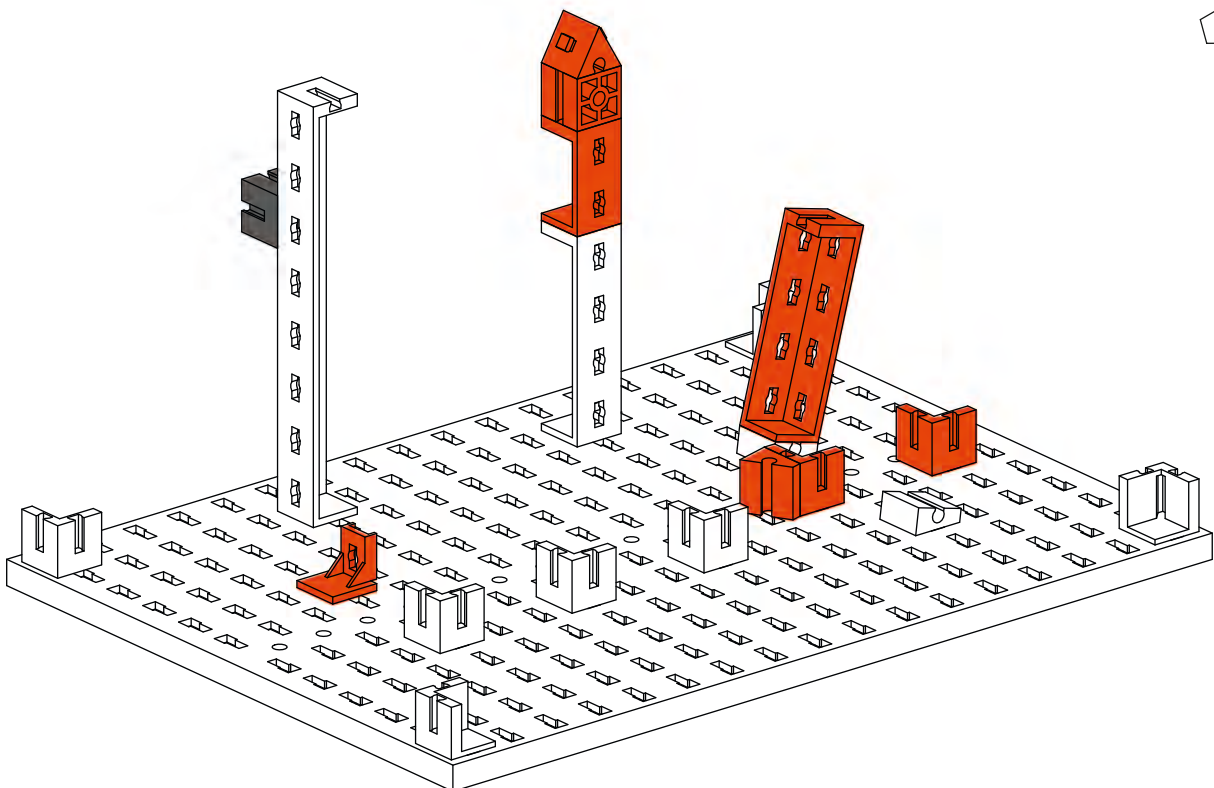
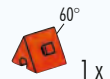
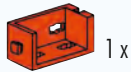
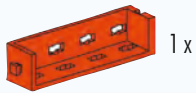



11



4 x



4 x



7,5°  
4 x

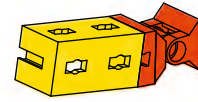

4 x



12



1 x



1 x



1 x



1 x



7,5°  
1 x

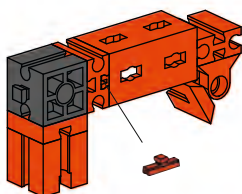
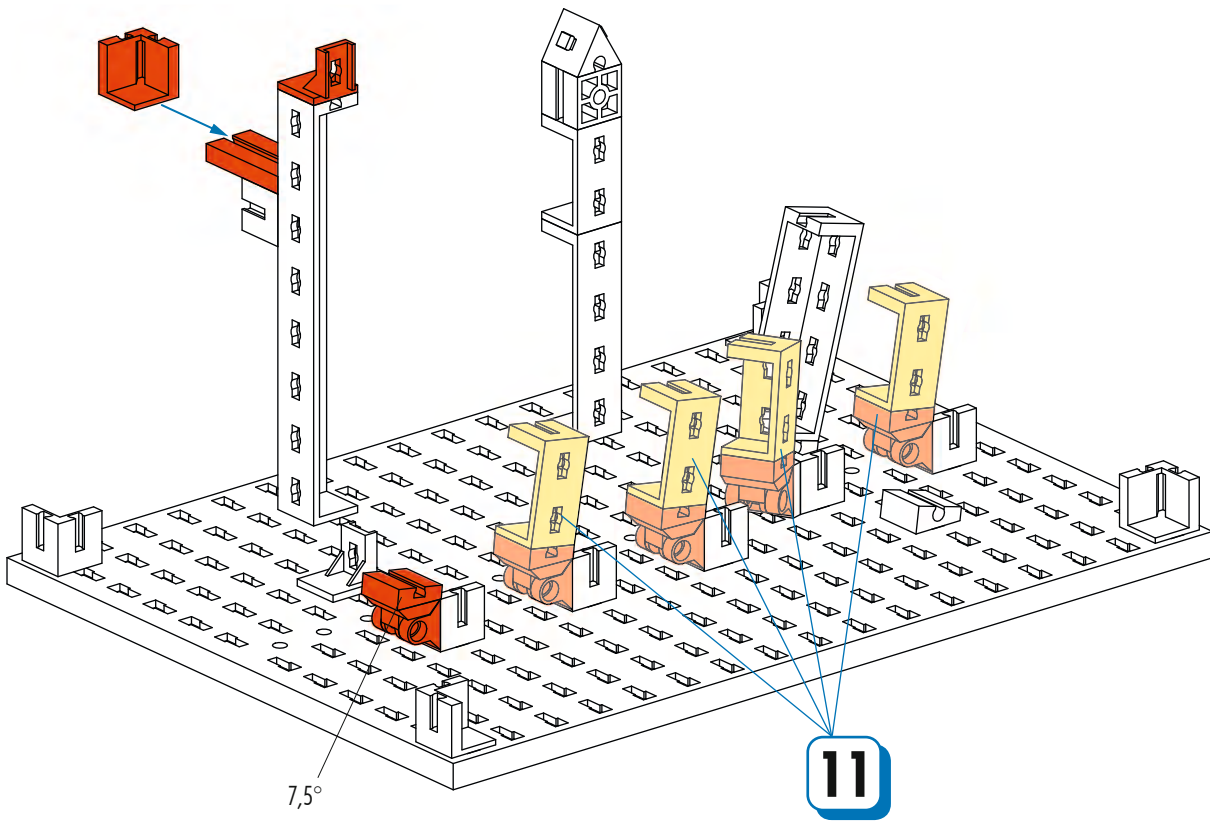

13



1 x



1 x



1 x



1 x



2 x



1 x



1 x

- 14**
- 1x 15°
  - 1x
  - 1x
  - 1x
  - 4x

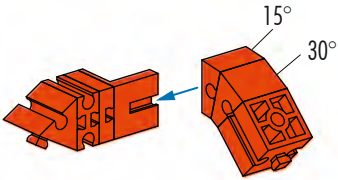
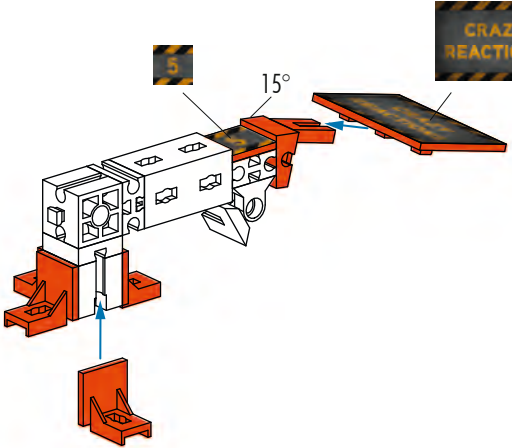

- 15**
- 1x
  - 1x
  - 1x
  - 1x
  - 1x
  - 1x
  - 1x
  - 1x

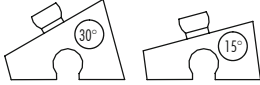

- 16**
- 1x
  - 1x
  - 3x
  - 1x

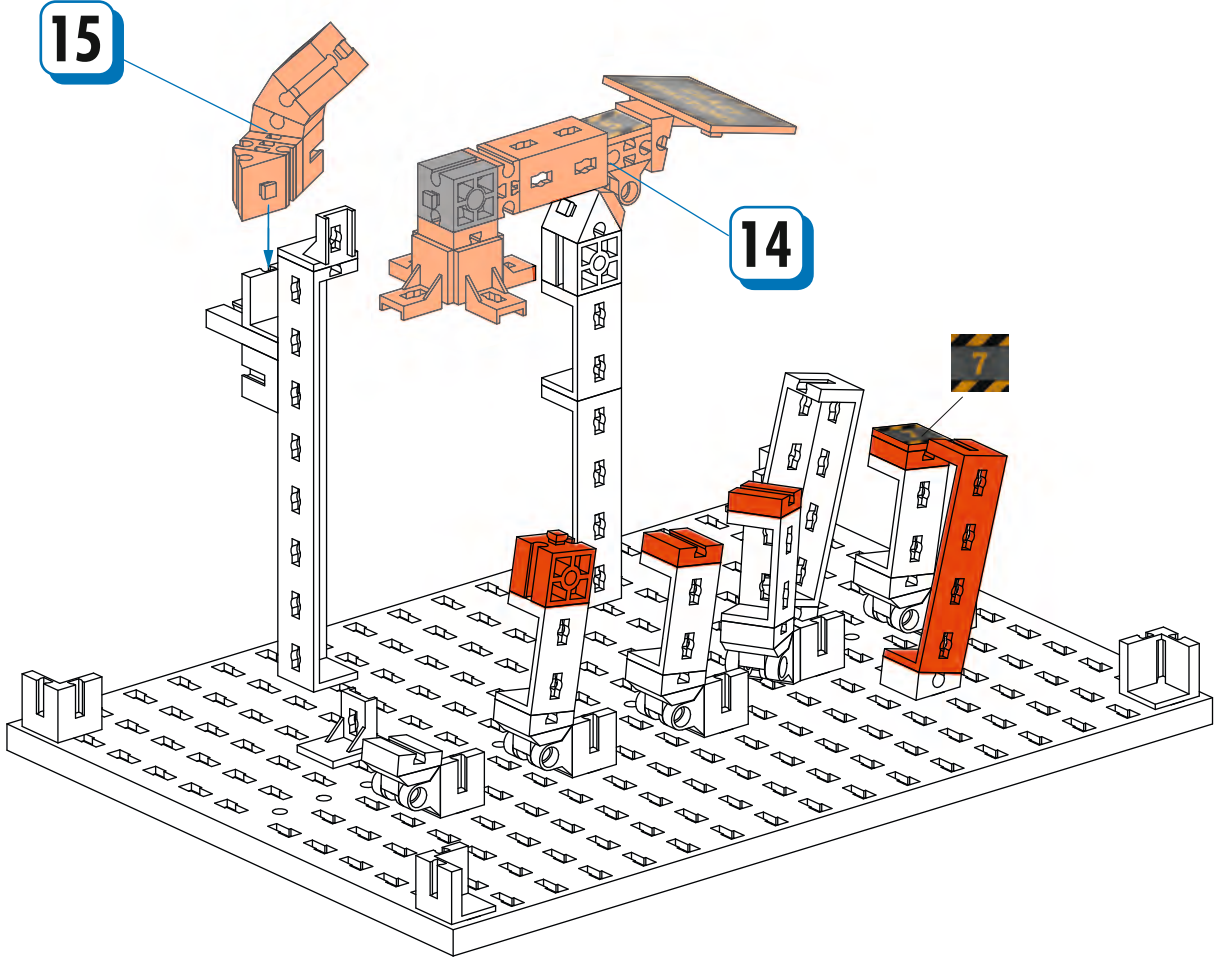

17

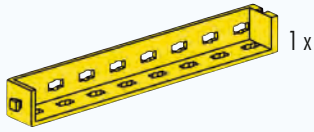

1 x



1 x



1 x



45 cm

1 x

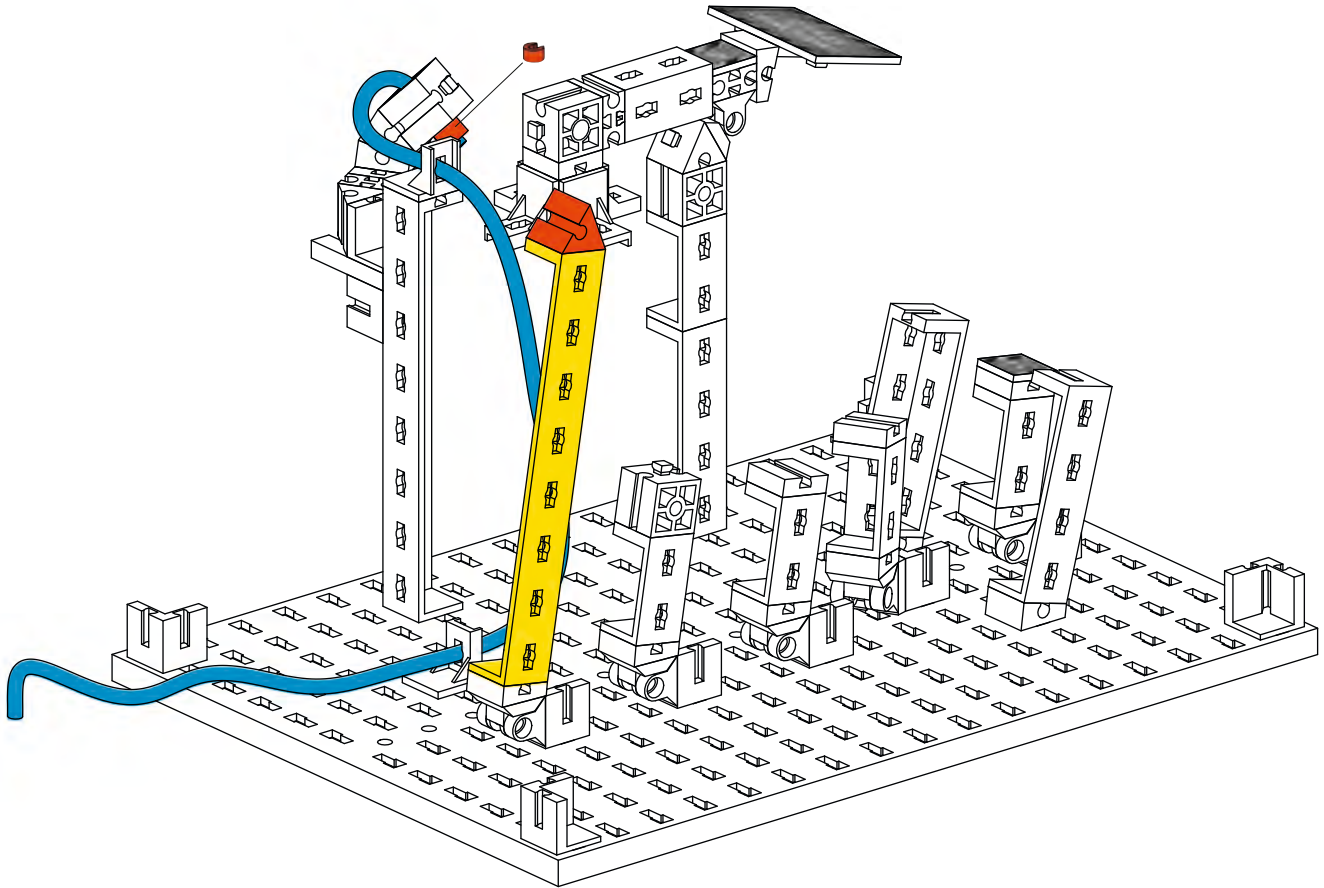

18

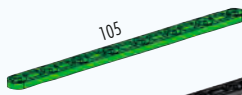

2 x



1 x



2 x



6 x



1 x

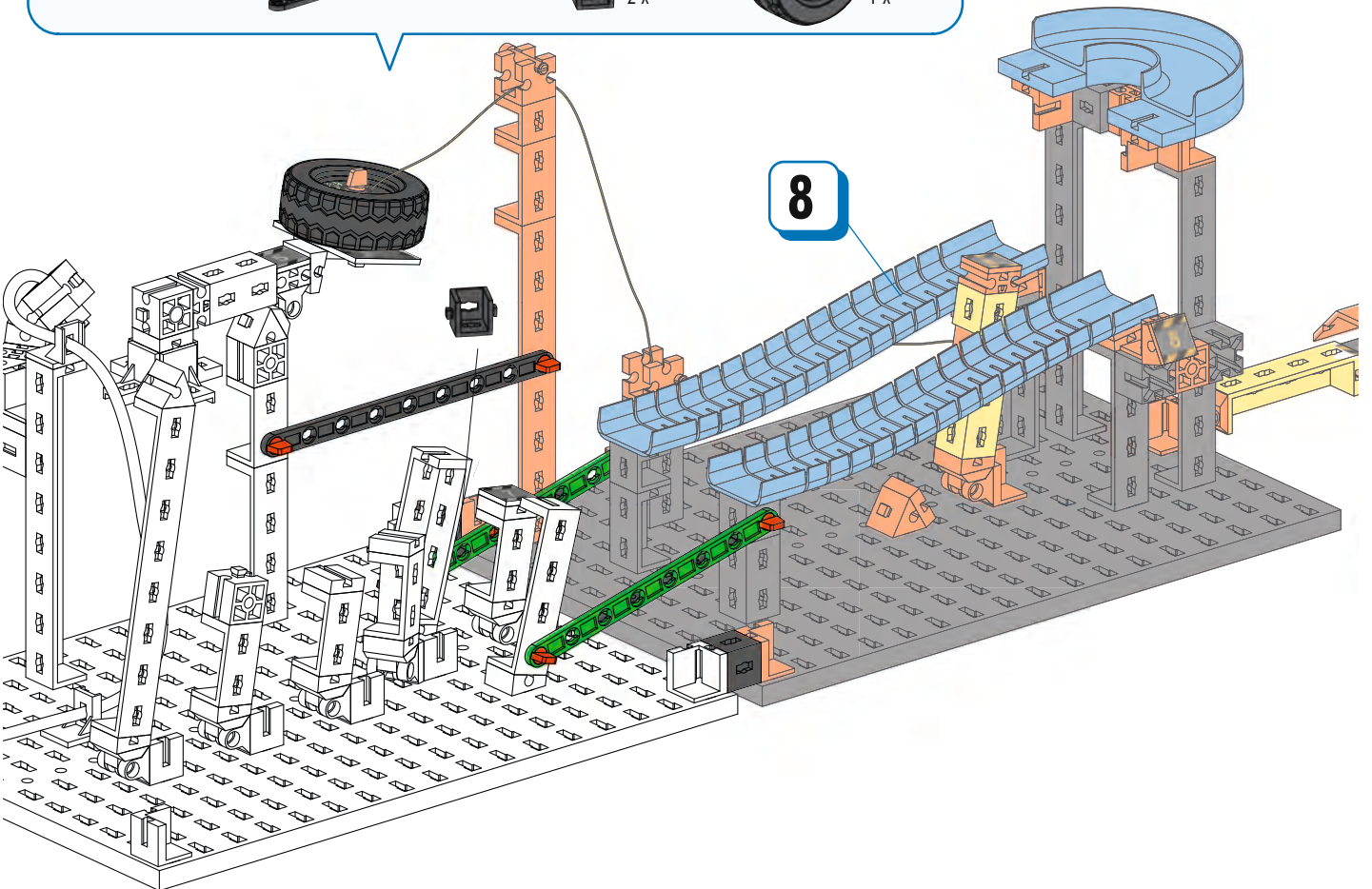

19

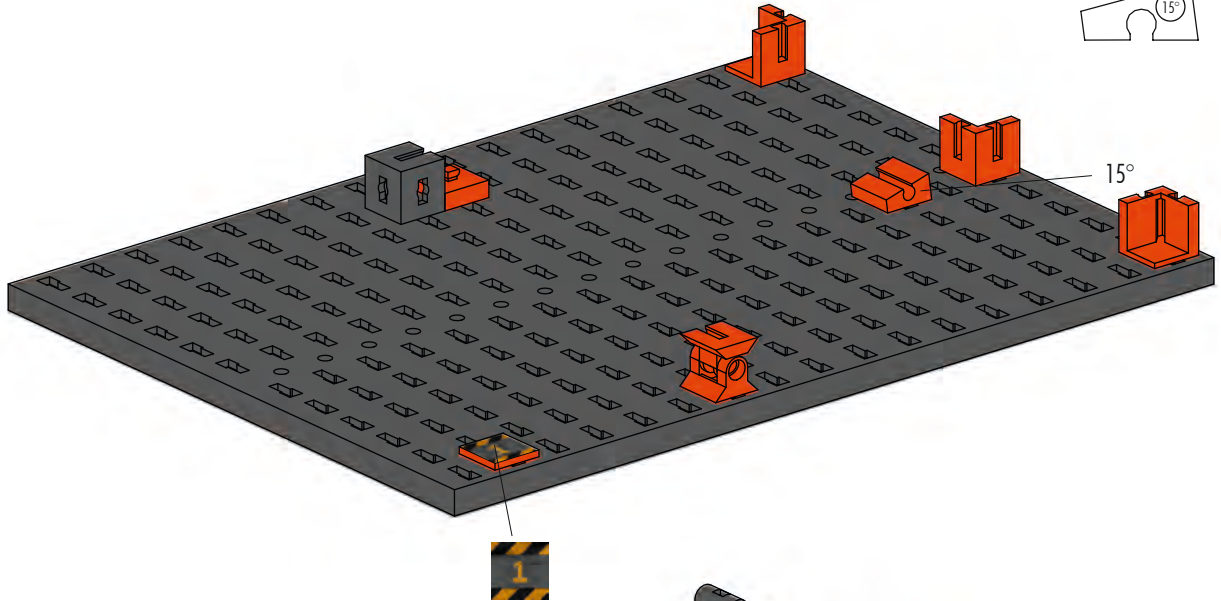
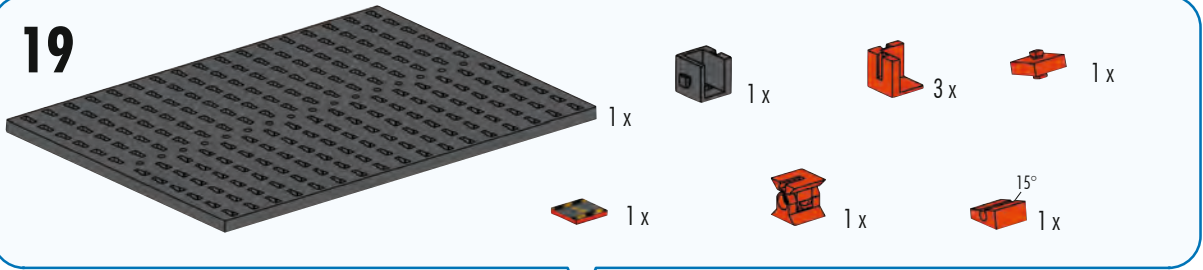

20

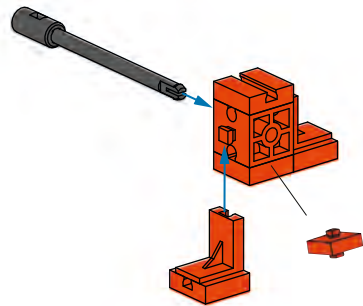
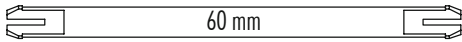

21

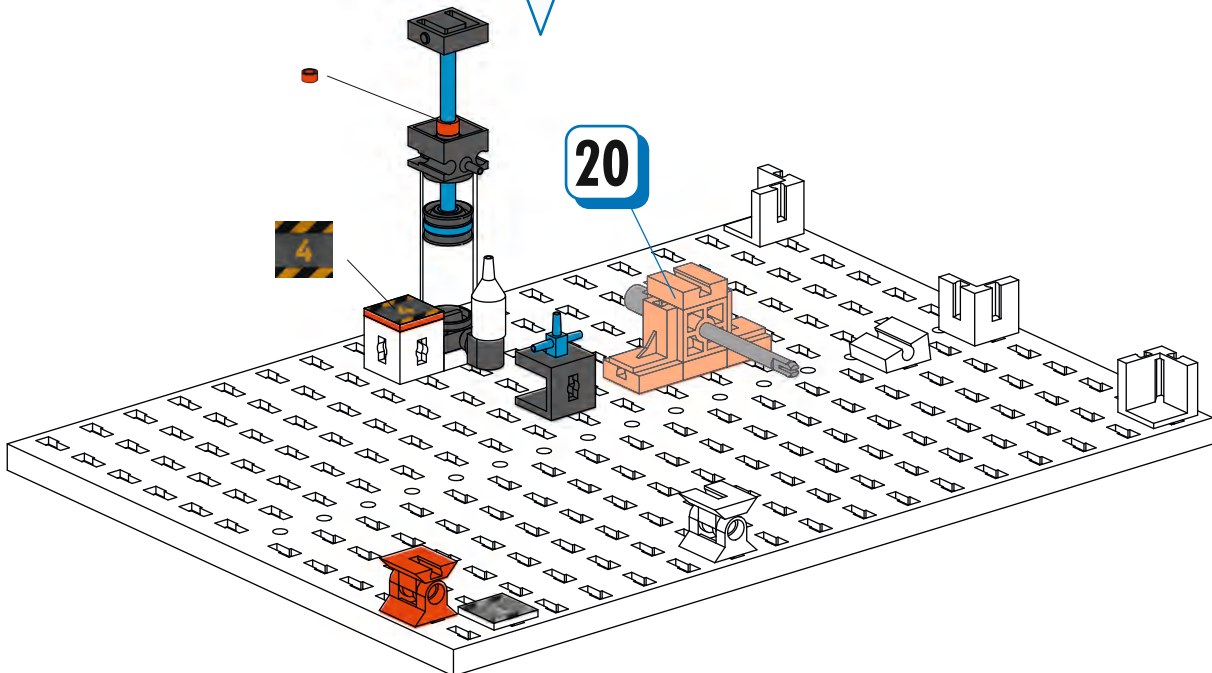
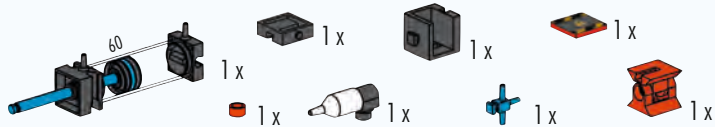





# 24

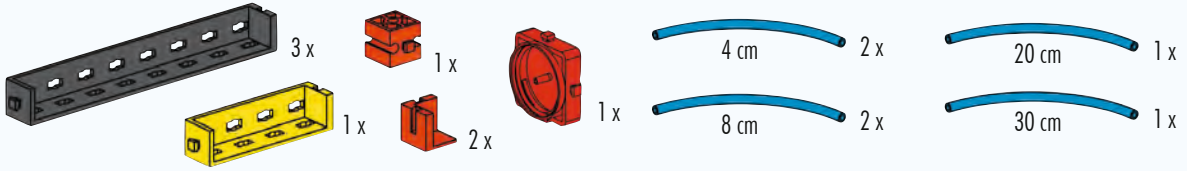

oder  
ou  
ou  
ou  
ou  
или  
或

Montagetipps Seite 2 / Tips for assembly Page 2 / Tuyaux pour le montage page 2 / Montagetips zie bladzijde 2 / Consejos para el montaje, ver la página 2 / "Dicas" para montagem - Página 2 / Consigli per il montaggio, pagina 2 / Советы по сборке, страница 2 / 装配建议第2页

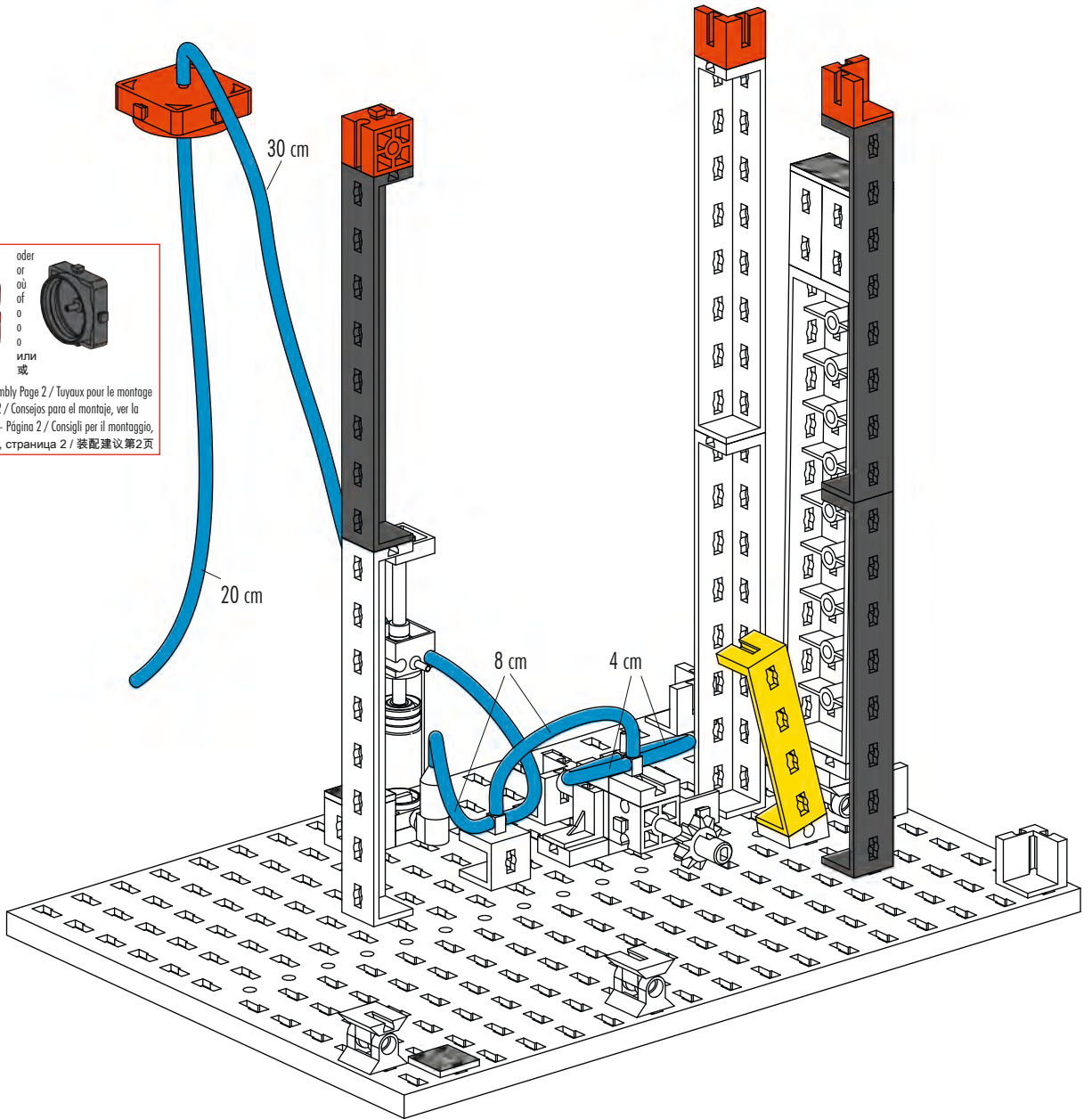

# 25

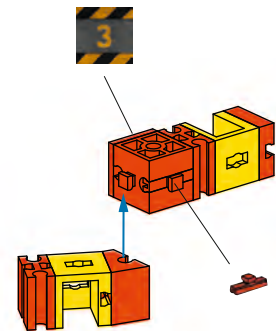
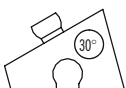
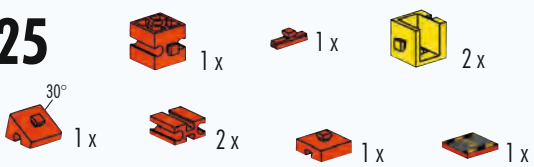

**26**

- 1x [Red 2x3 Technic Brick]
- 1x [Red 1x3 Technic Pin]
- 1x [Red 1x3 Technic Pin]
- 2x [Red 1x3 Technic Pin]
- 1x [Red 1x3 Technic Pin]
- 1x [Red 1x3 Technic Pin]

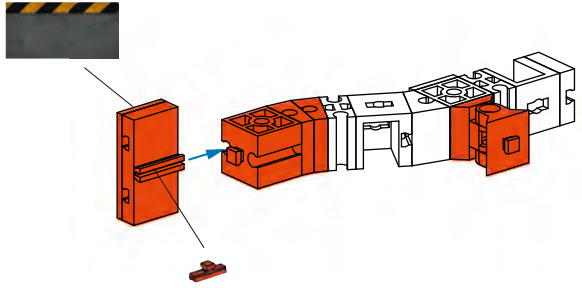

**27**

- 1x [Grey 1x10 Technic Beam]
- 1x [Grey 1x3 Technic Pin]
- 2x [Red 2x3 Technic Brick]
- 1x [Red 1x3 Technic Pin]
- 1x [Red 1x3 Technic Pin]
- 1x [Red 60-degree Technic Pin]

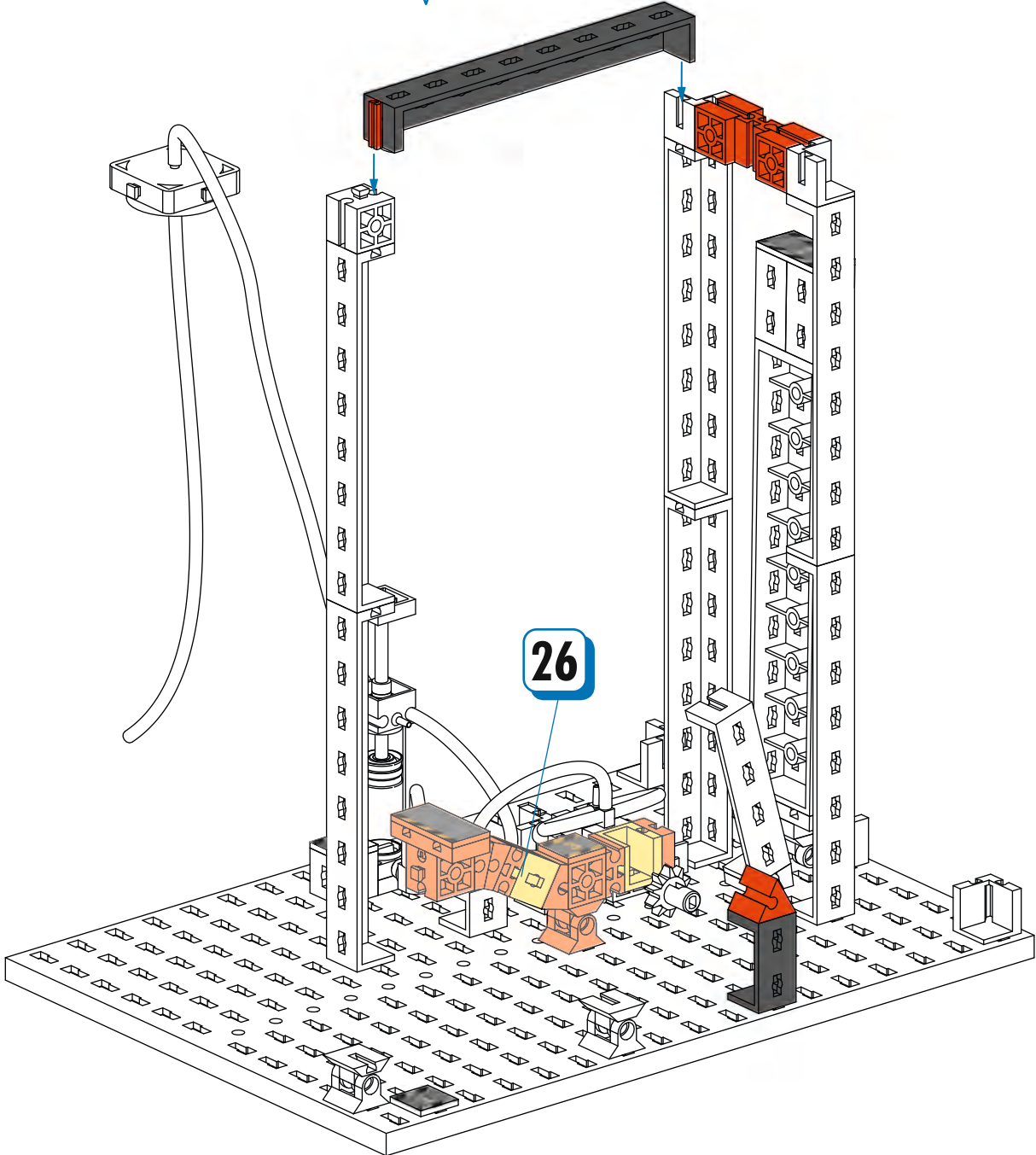





31

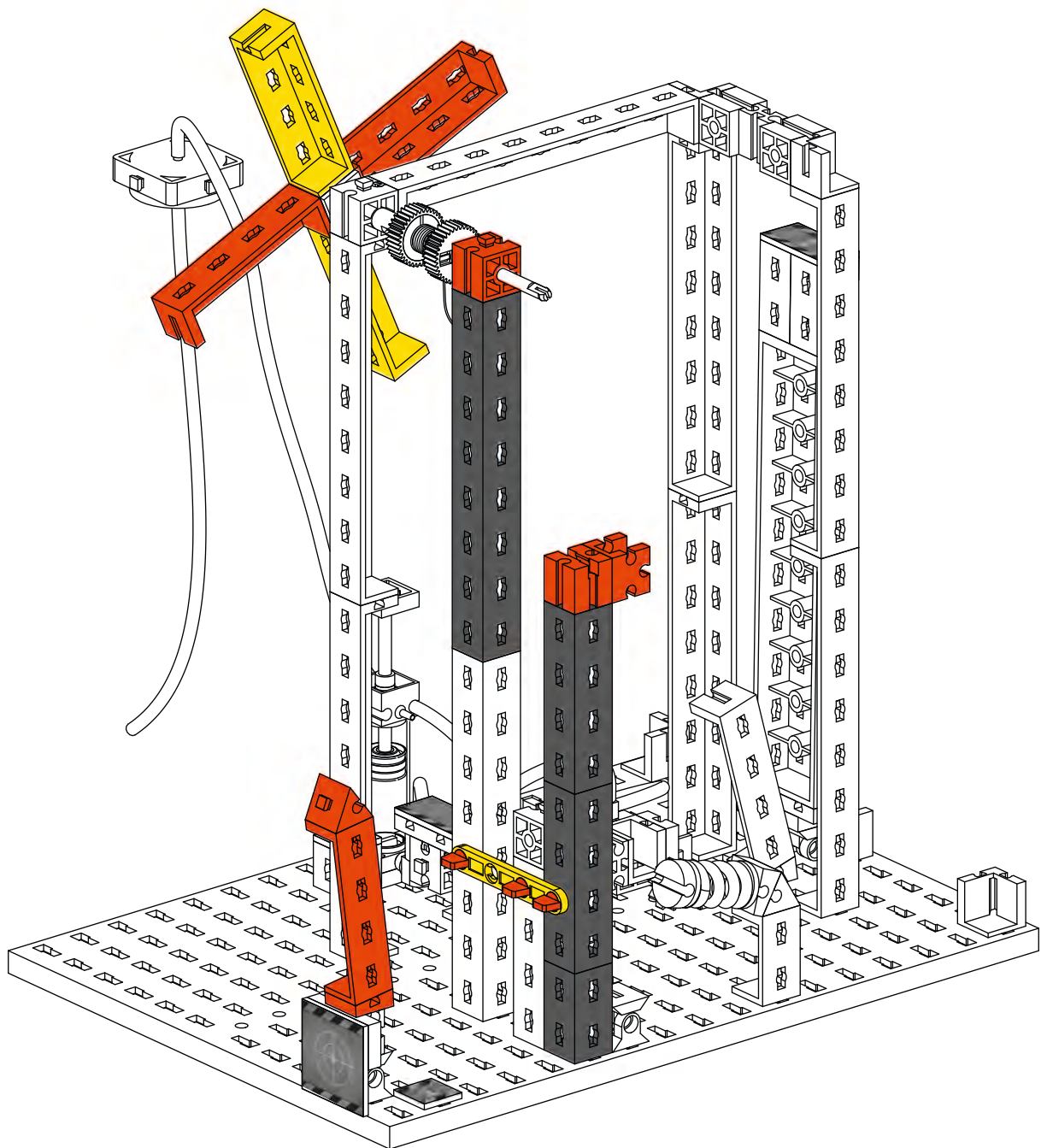
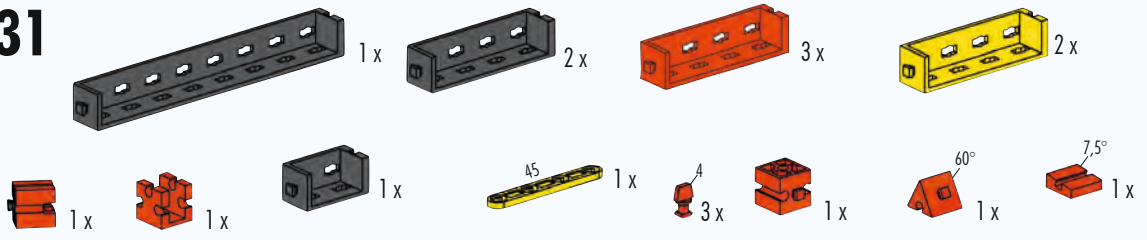



33

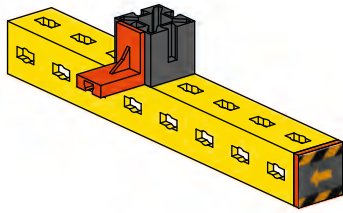
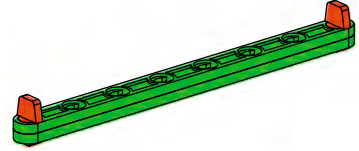
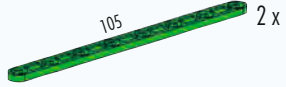

34

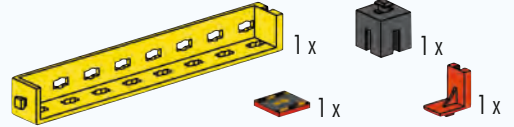

35

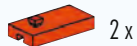

**36**

- 1x [Red L-shaped Technic brick]
- 1x [Red 1x3 Technic brick with hole]
- 1x [Red 1x3 Technic brick with hole]
- 1x [Red 1x3 Technic brick with hole]
- 1x [Red 1x3 Technic brick with hole]
- 2x [Red 1x3 Technic brick with hole]

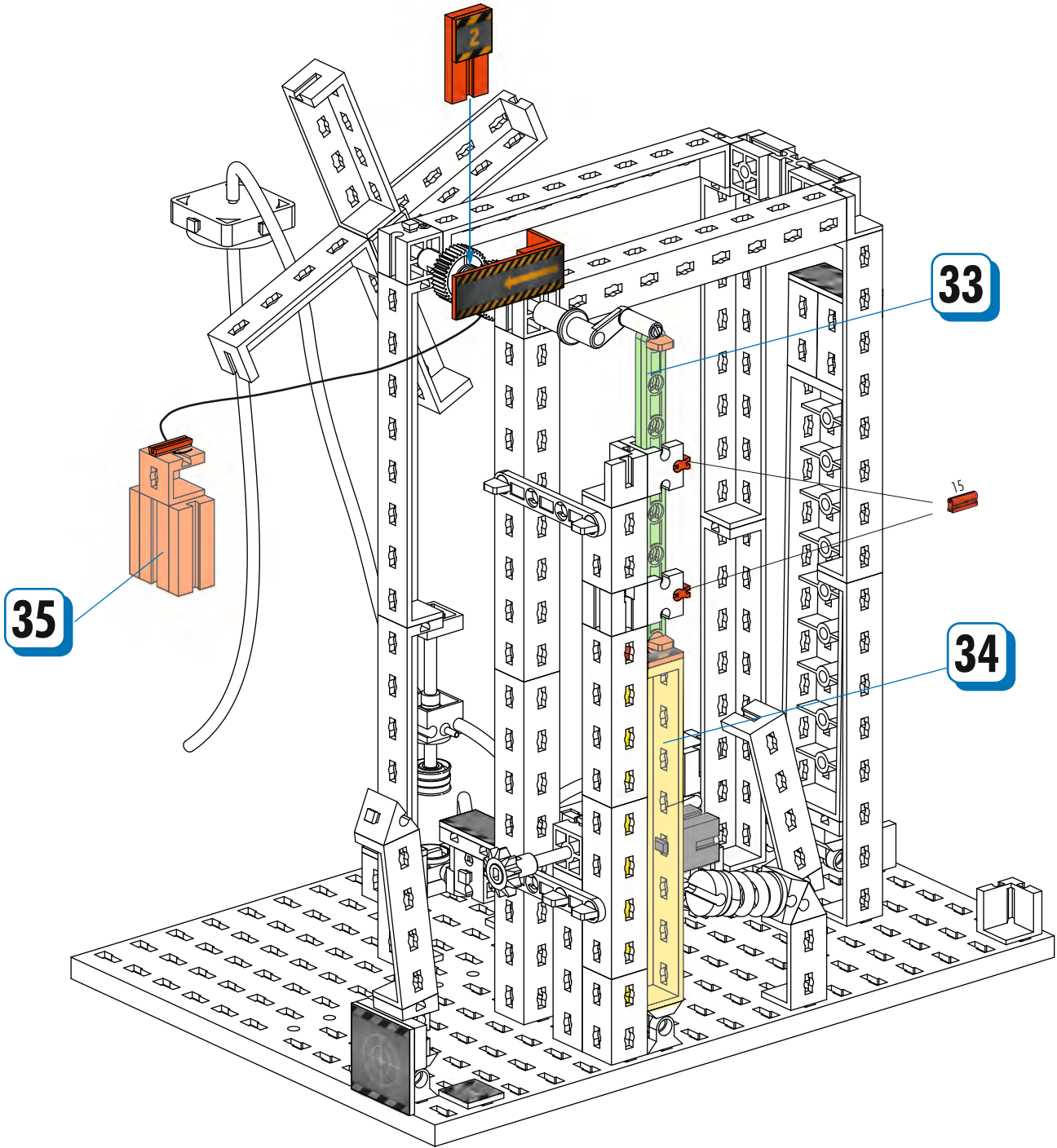

**37**

- 1x [Green Technic connector]
- 2x [Red Technic connector]
- 1x [Red 1x3 Technic brick with hole]
- 2x [Red 30-degree Technic connector]

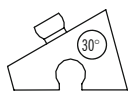
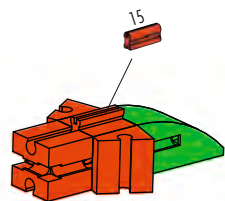



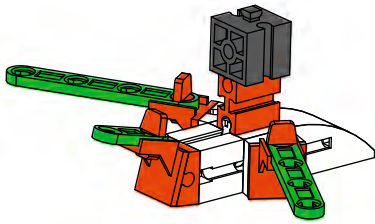

**38**

- 3x (Red L-shaped Technic connector)
- 1x (Grey Technic axle)
- 2x (Green Technic beam, length 45)
- 1x (Red Technic 15-degree angled connector)
- 1x (Green Technic beam, length 15)
- 3x (Red Technic pin)
- 1x (Red Technic 15-degree angled connector)

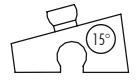

**39**

- 2x (Grey Technic axle)
- 1x (Red L-shaped Technic connector)
- 1x (Red Technic 15-degree angled connector)
- 1x (Red Technic 15-degree angled connector)
- 1x (Red Technic 15-degree angled connector)
- 1x (Blue Technic infinity loop)

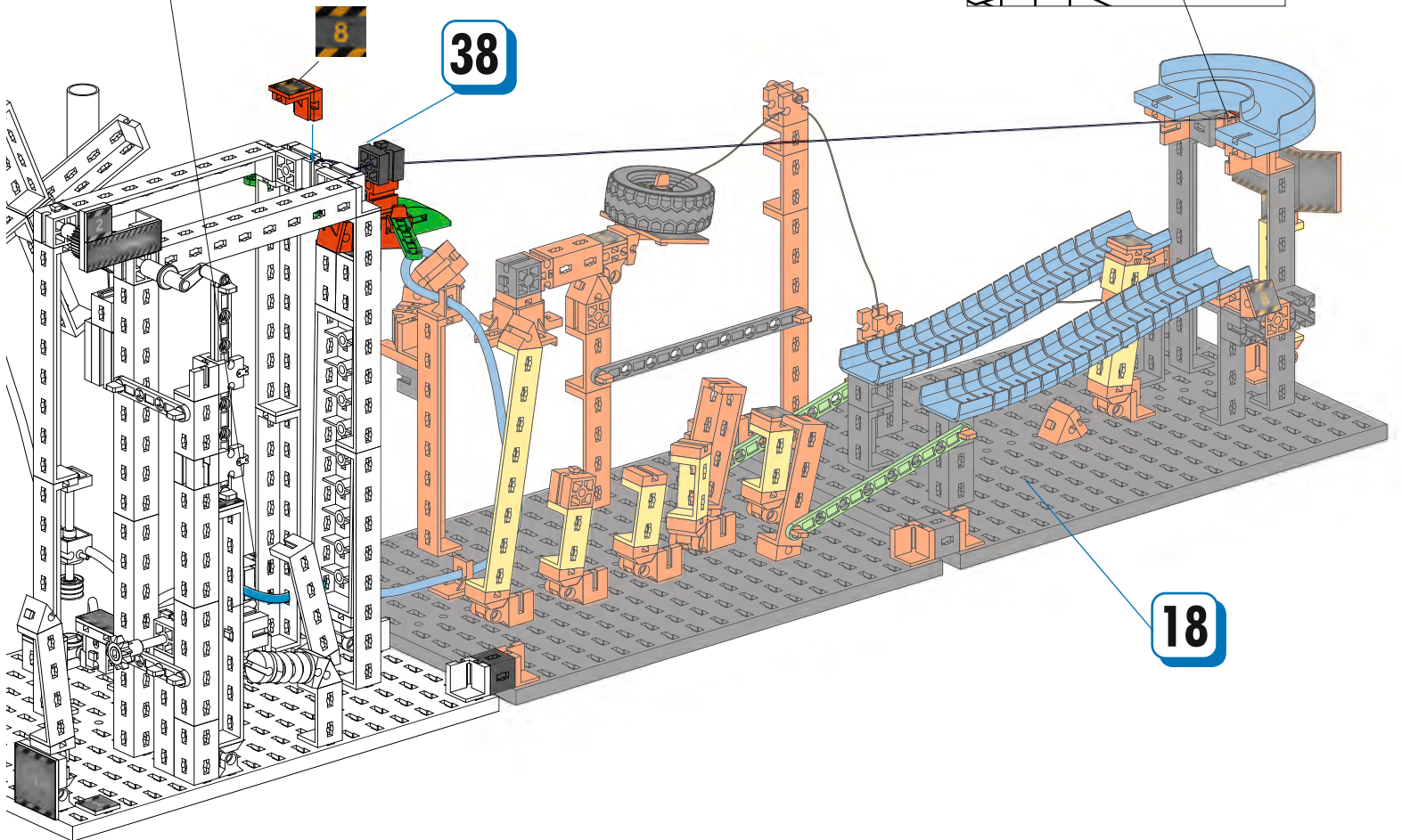
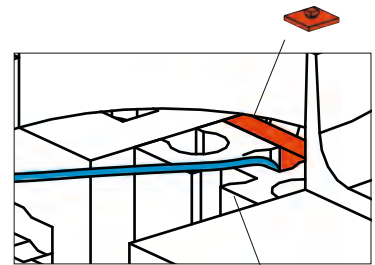
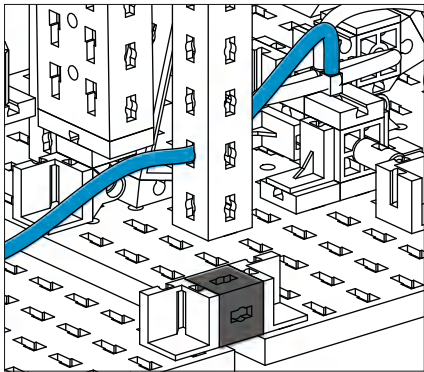

40



1x



- Tipps und Tricks zur Inbetriebnahme der Modelle
- Tips and tricks for commissioning the models
- Conseils et astuces pour la mise en service des modèles
- Tips en trucs voor het in opdracht geven van de modellen
- Consejos y trucos para encargar las maquetas
- Dicas e truques para o comissionamento dos modelos
- Consigli e suggerimenti per la messa in servizio dei modelli
- Советы и рекомендации по вводу моделей в эксплуатацию
- 调试模型的技巧+诀窍

- Kombiniere deine Modelle
- Combine your models
- Combine tes modèles
- Combineer je modellen
- Combine sus modelos
- Combine seus modelos
- Combinare i modelli
- Объедините свои модели
- 结合你的模型



<https://www.fischertechnik.de/crazyreactions-tutorials>