

# fischer<sup>®</sup>technik

# 50

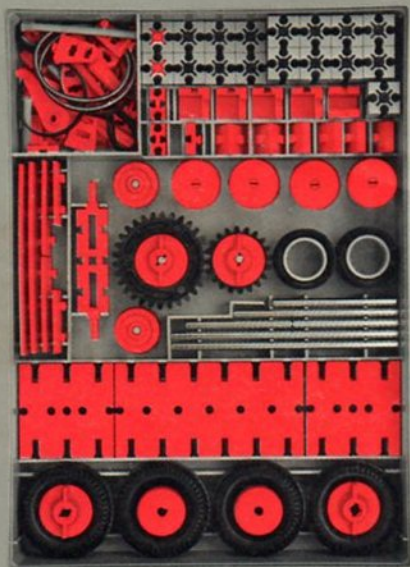

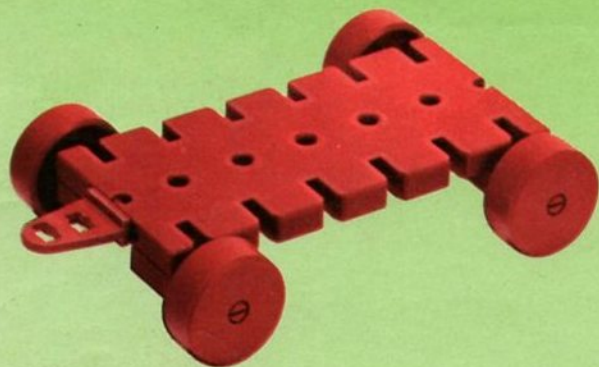

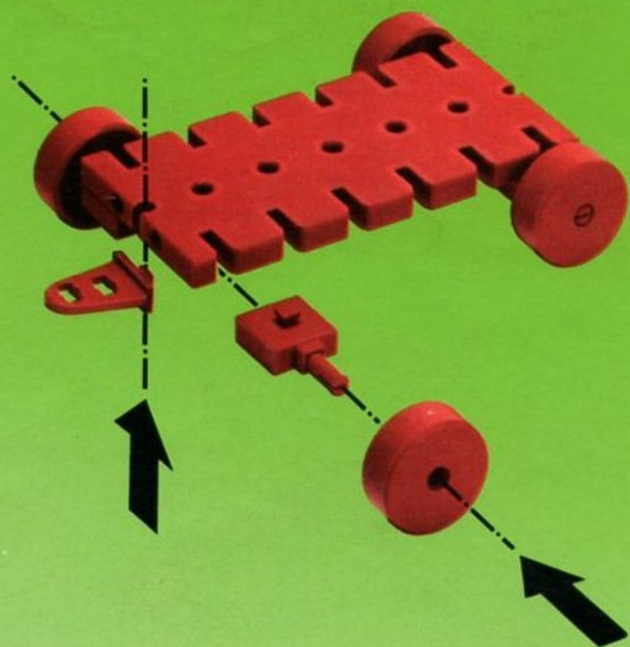

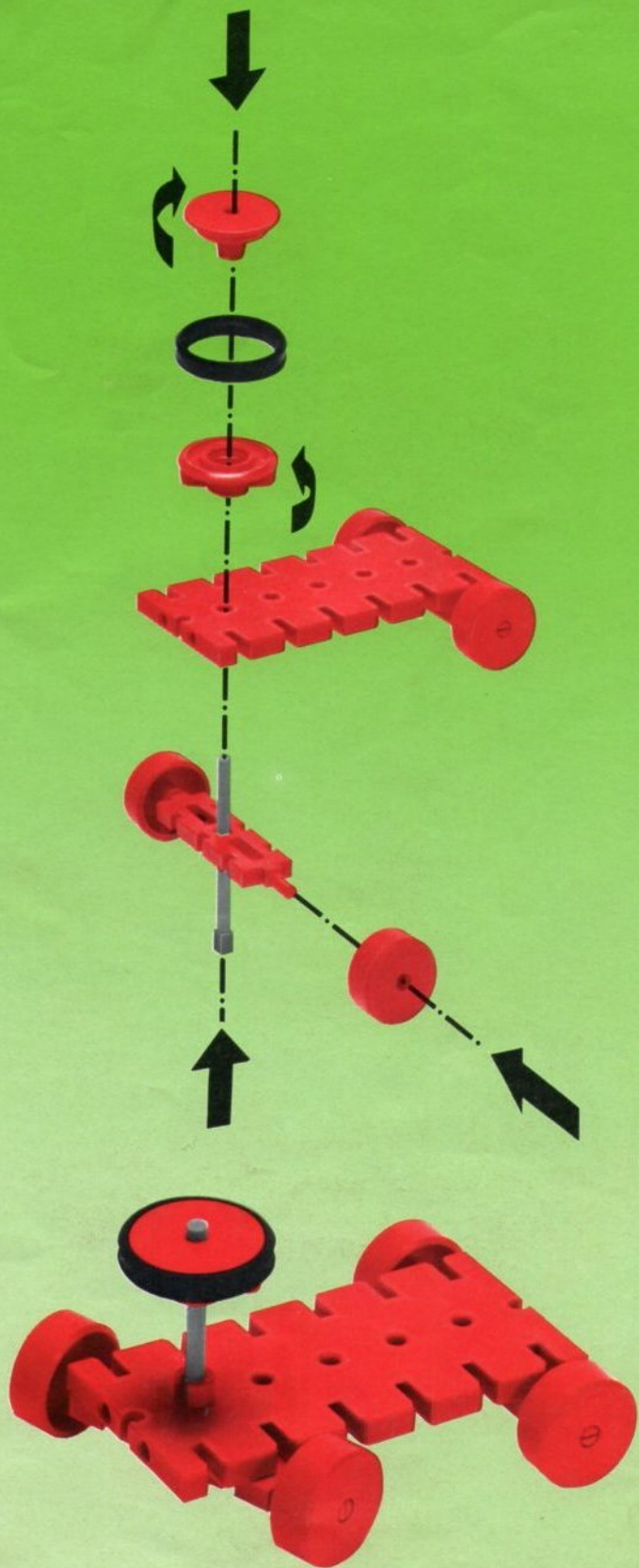

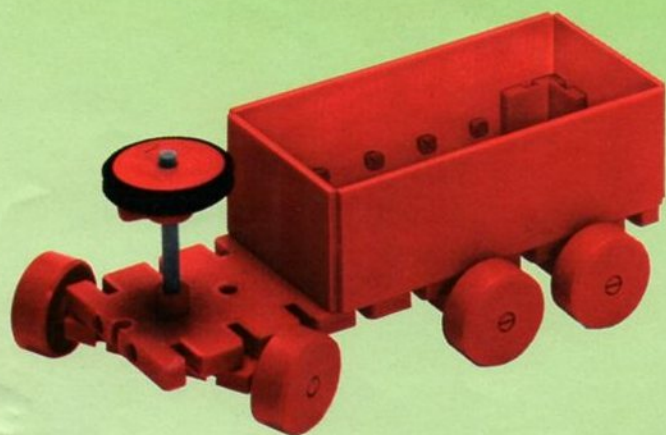
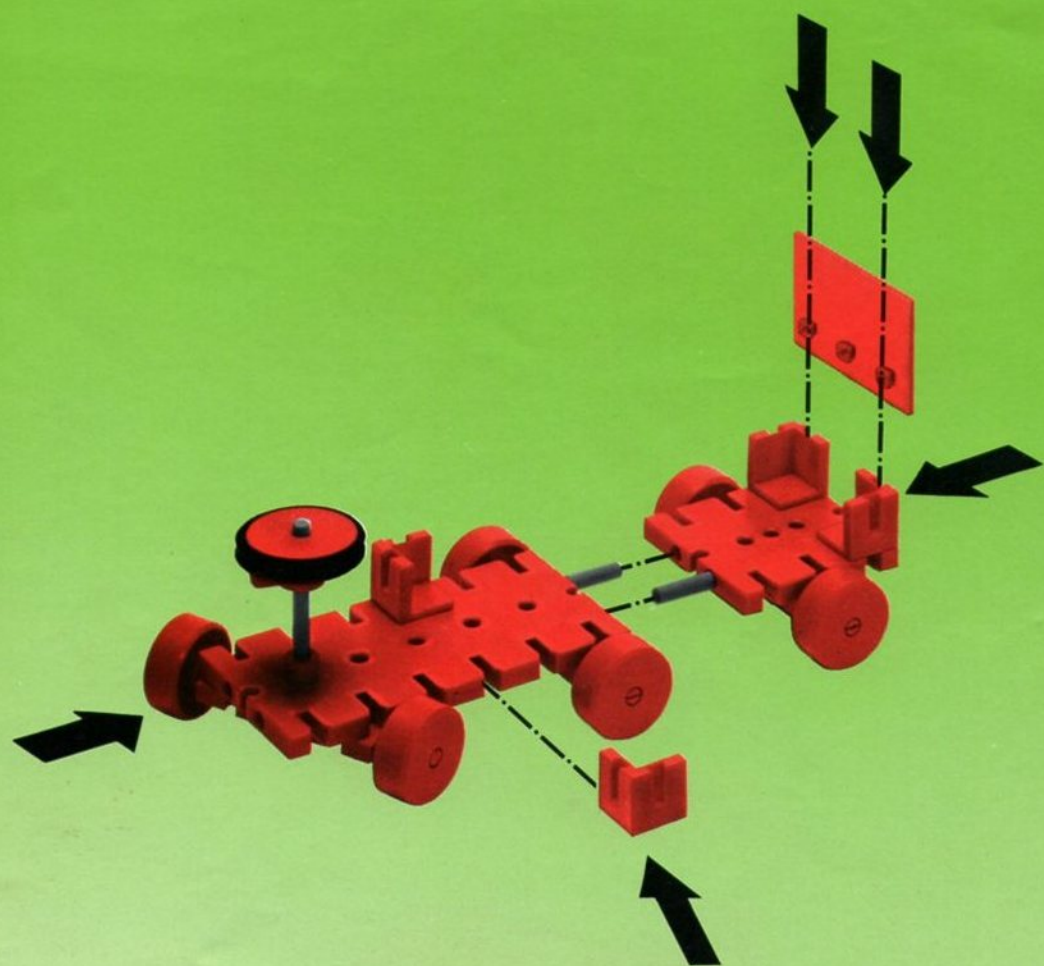



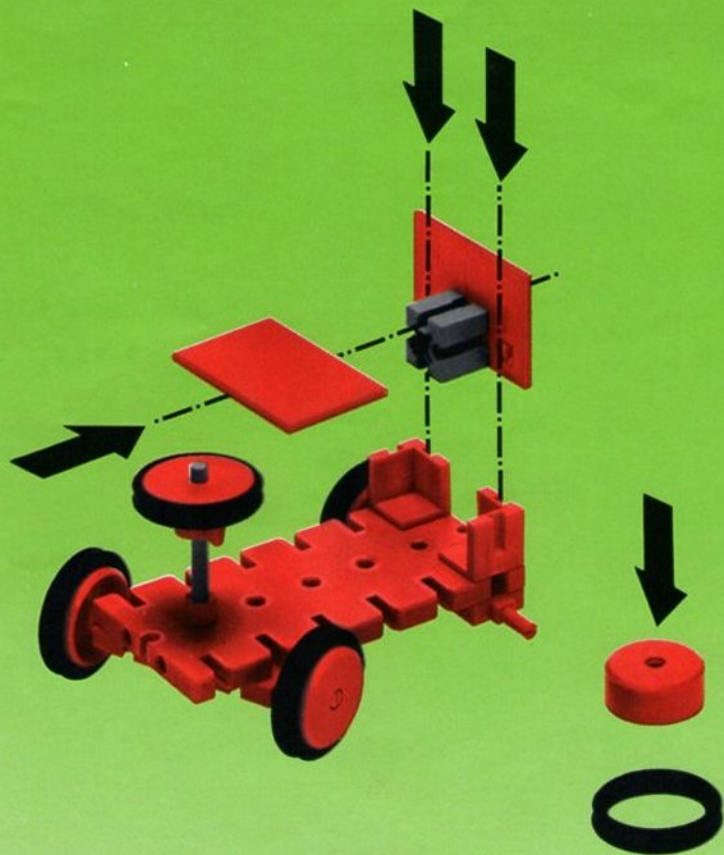

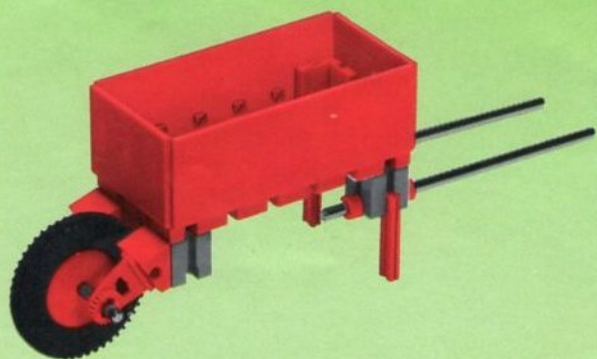
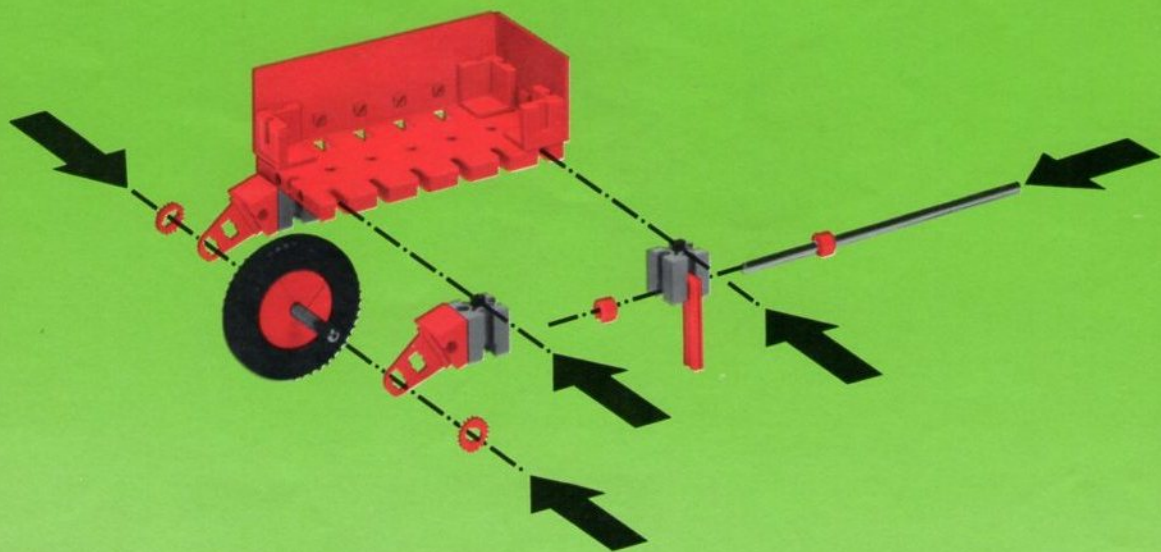



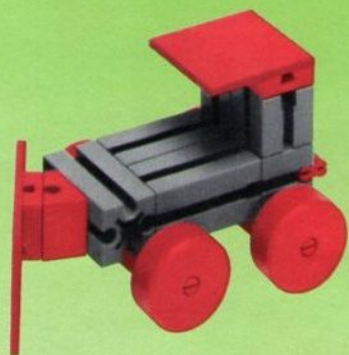
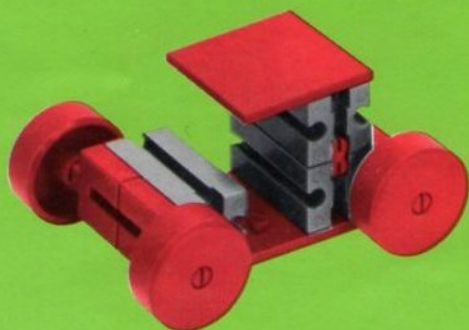

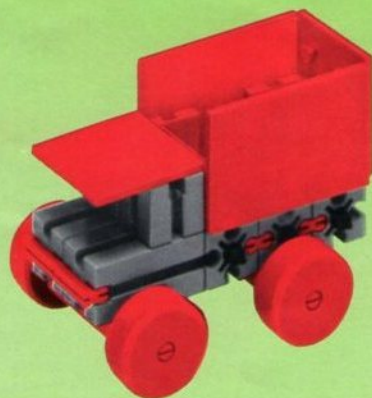
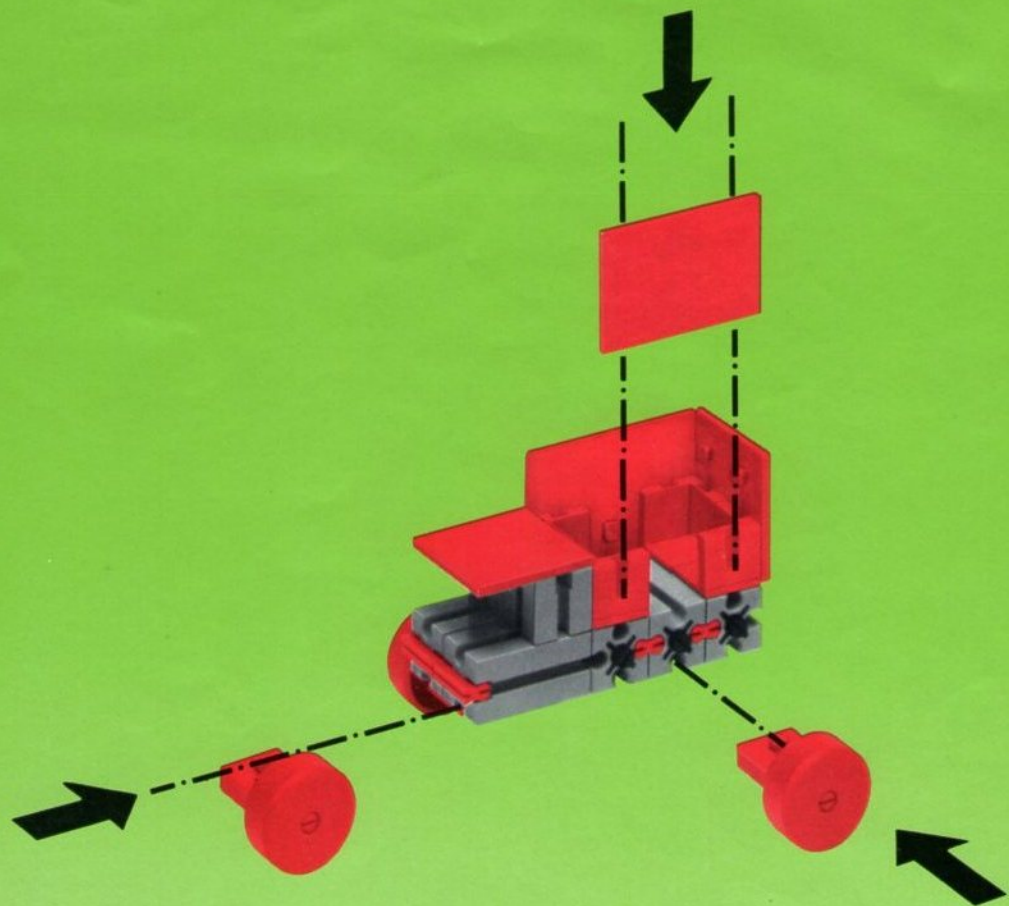



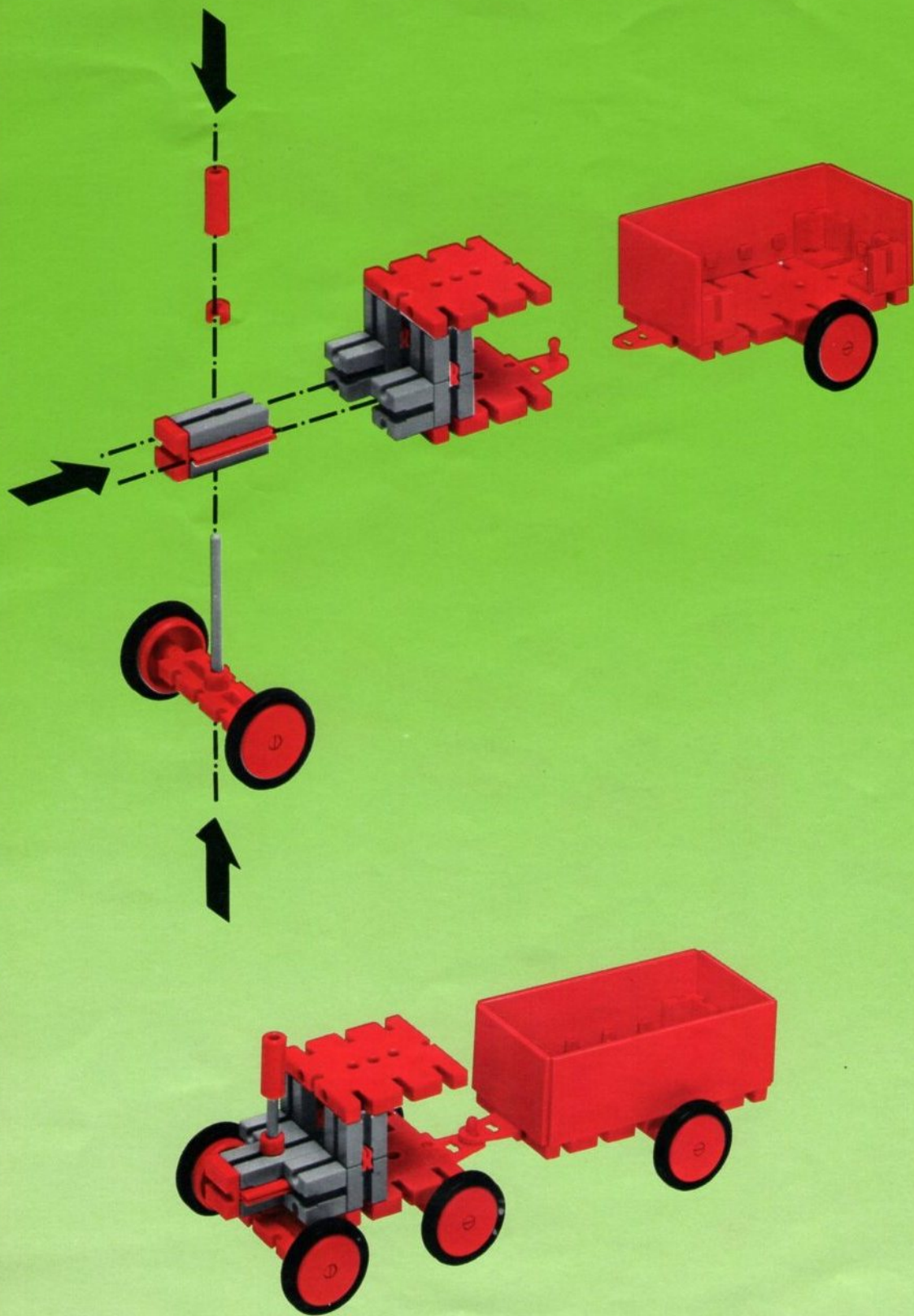

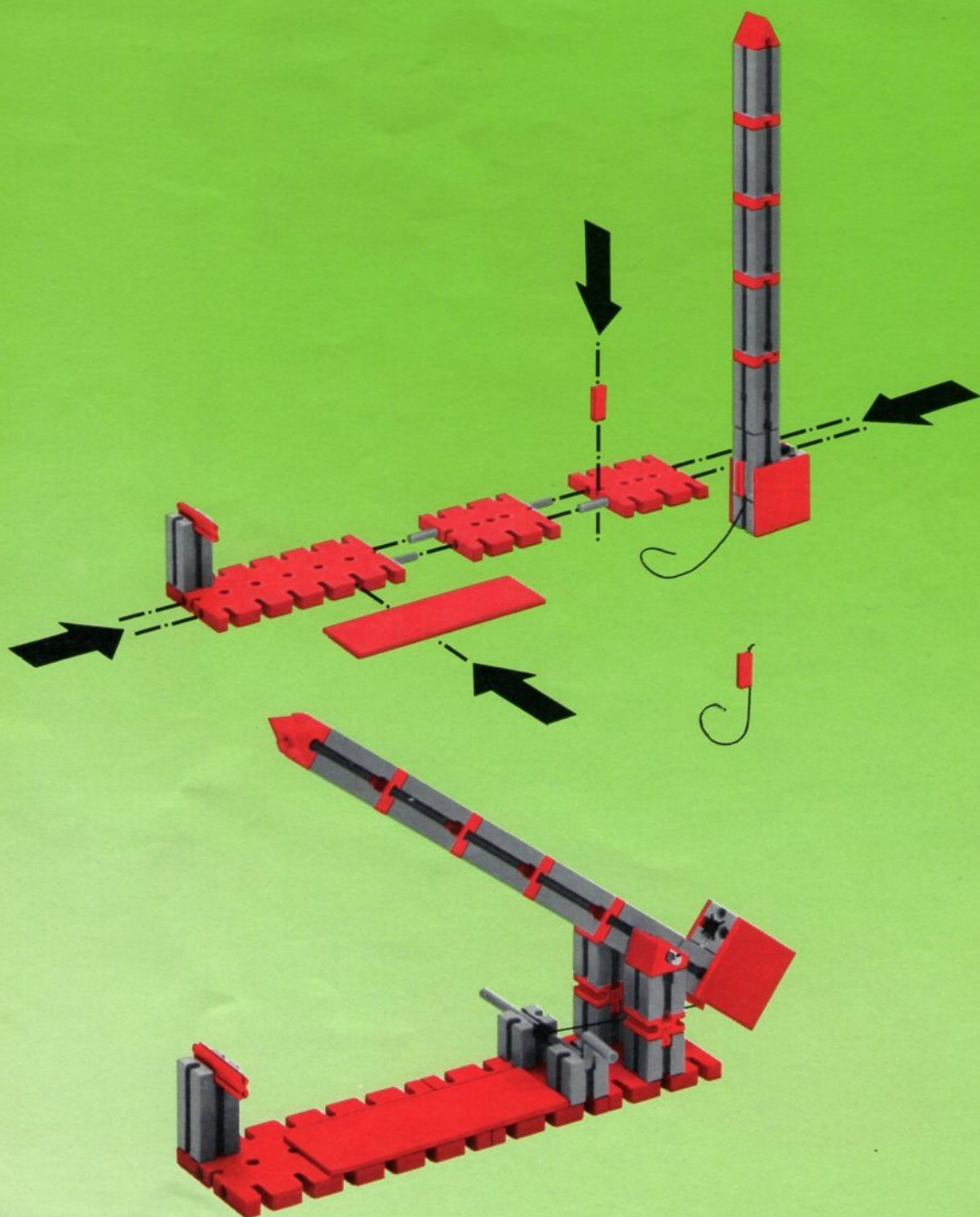



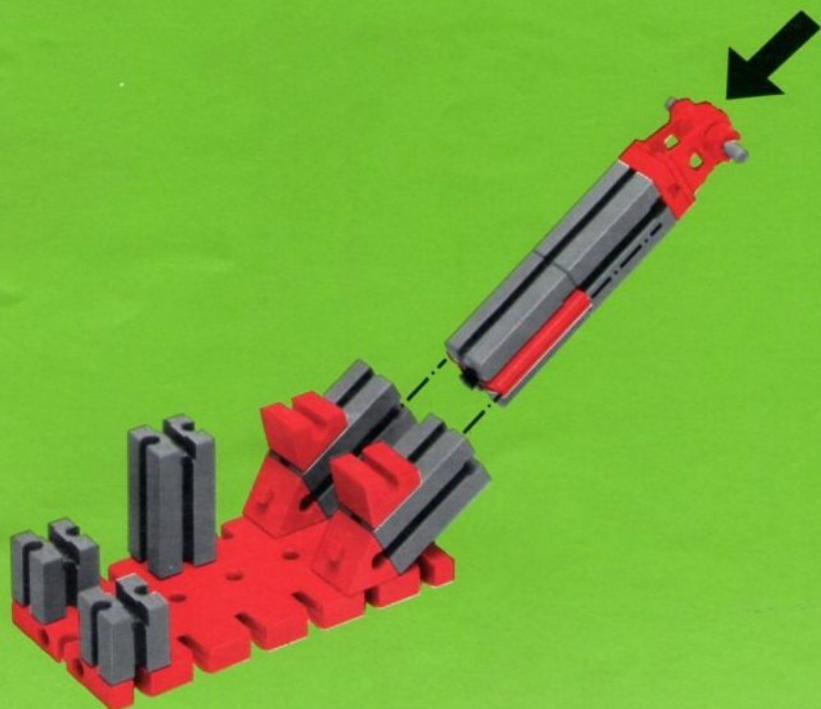

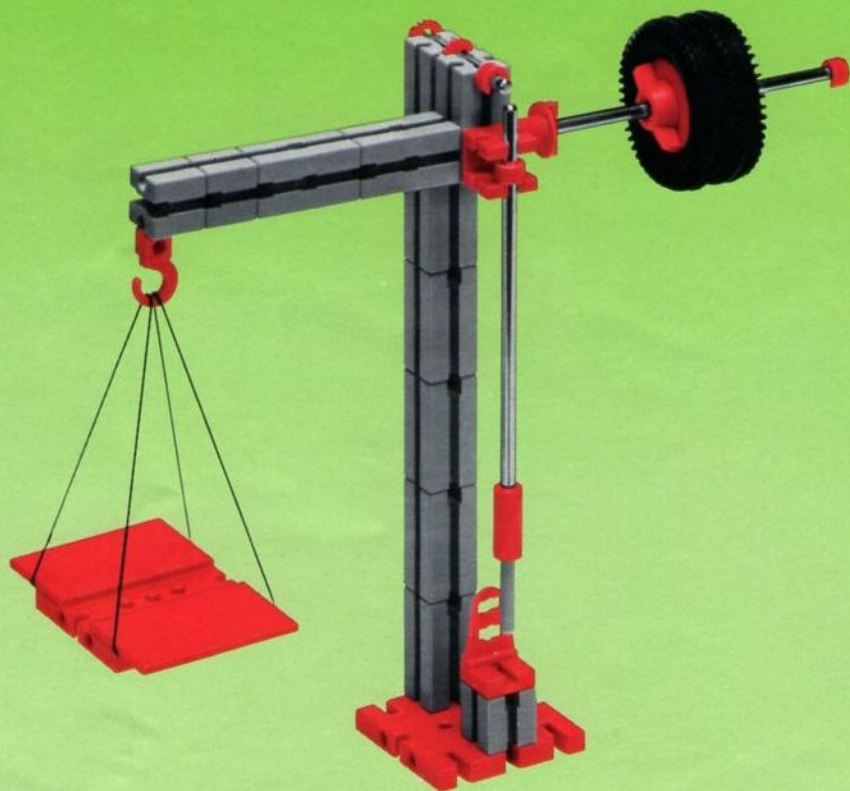
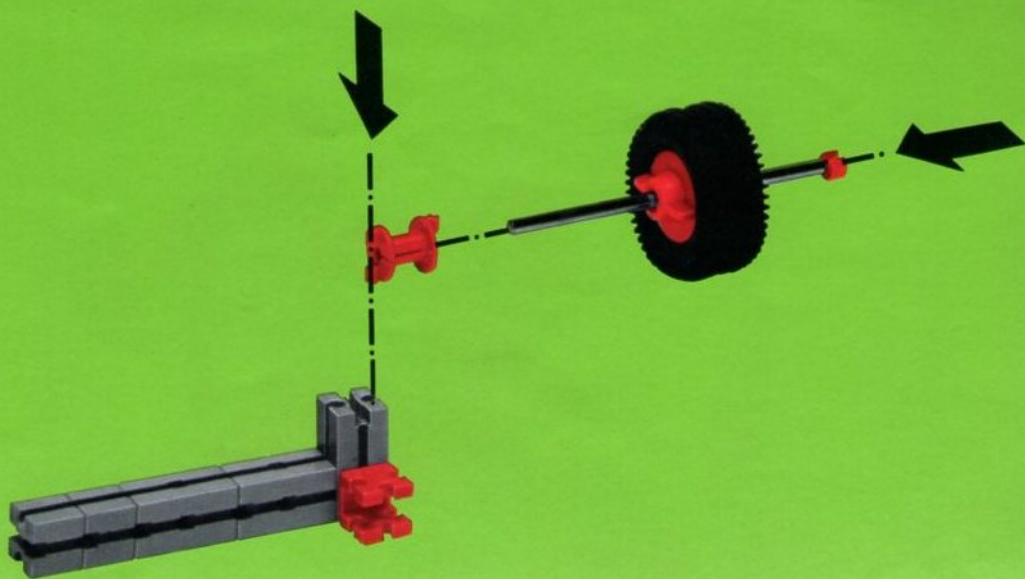



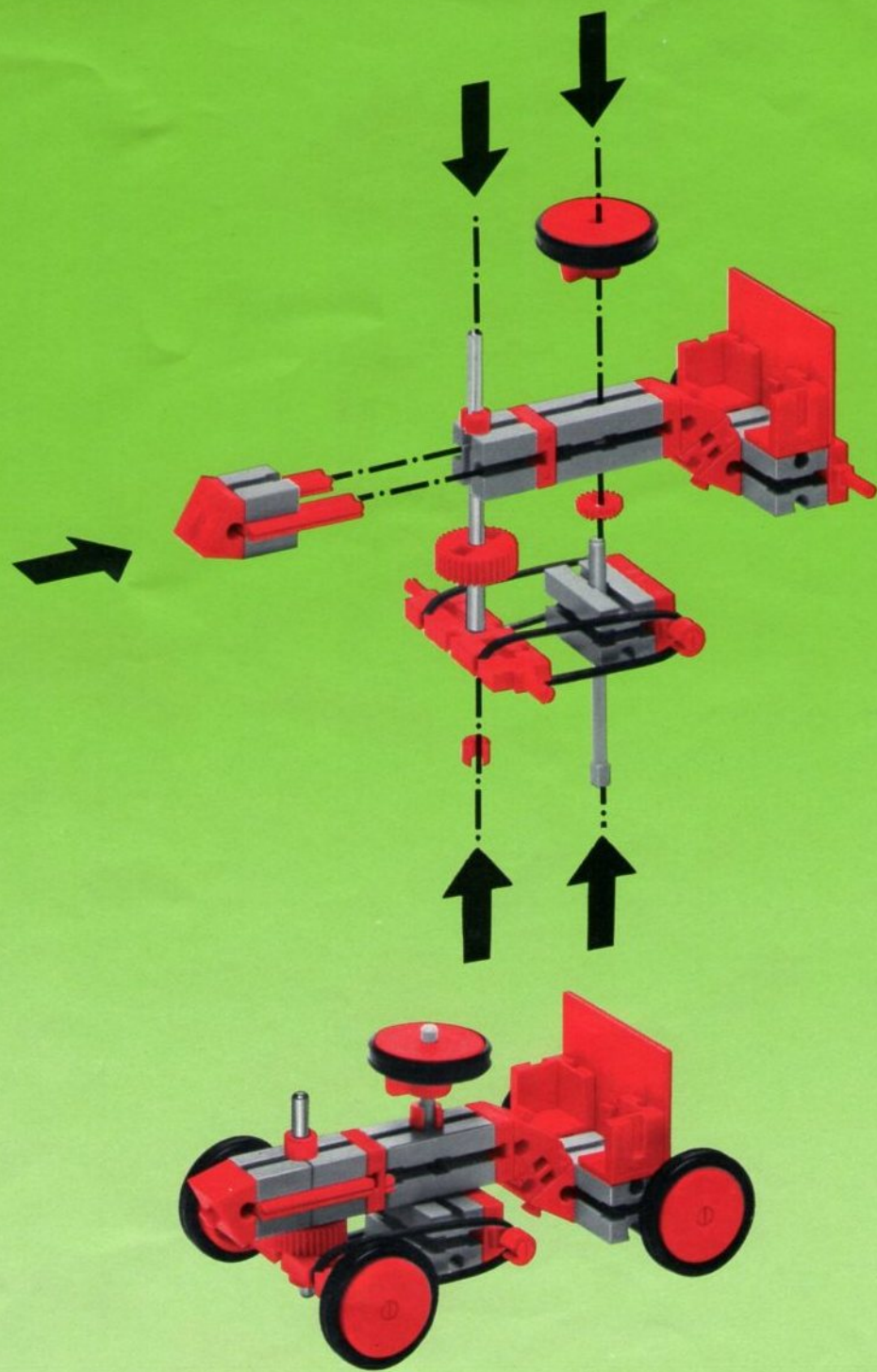

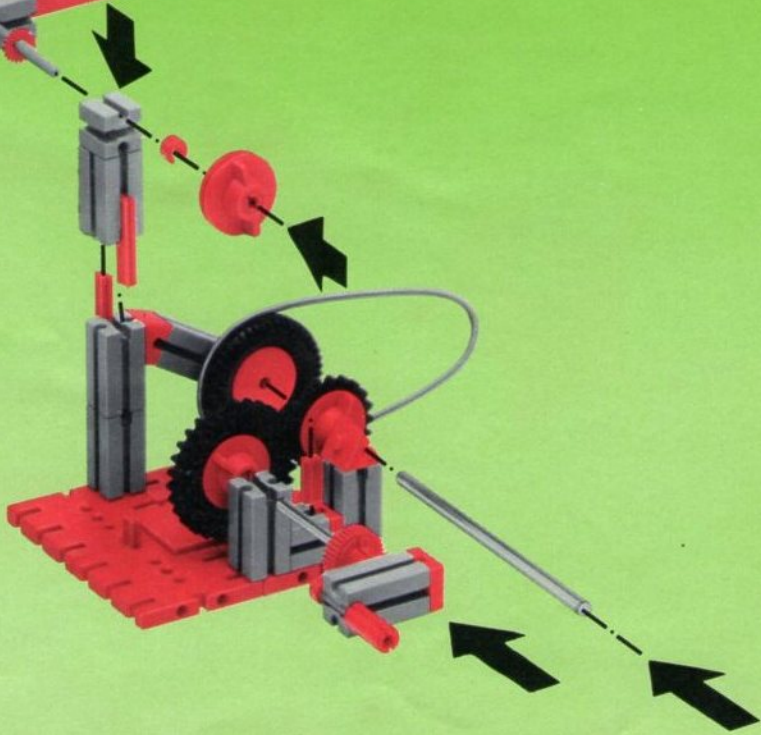
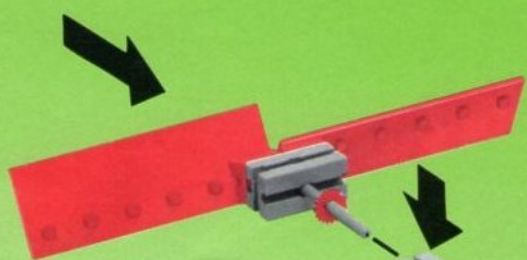
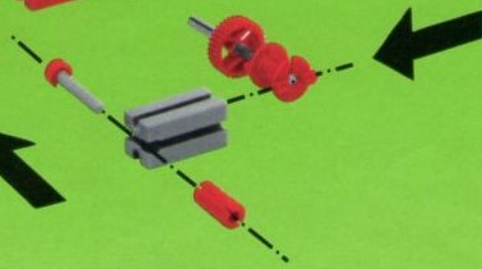
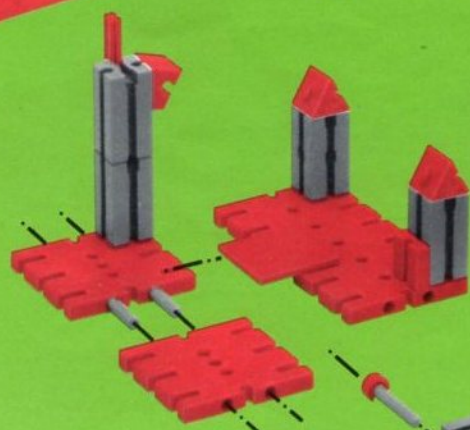
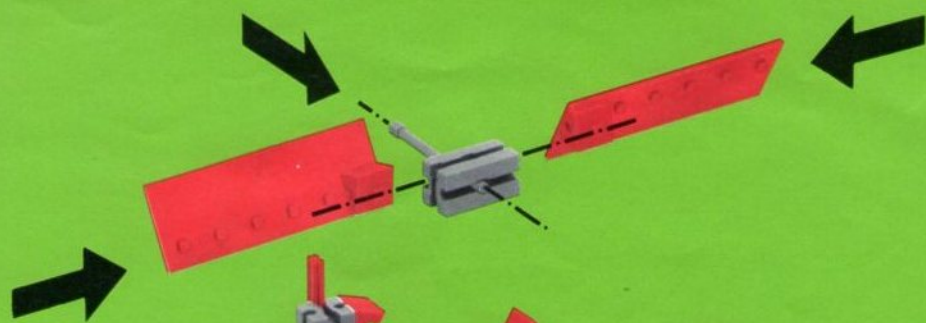



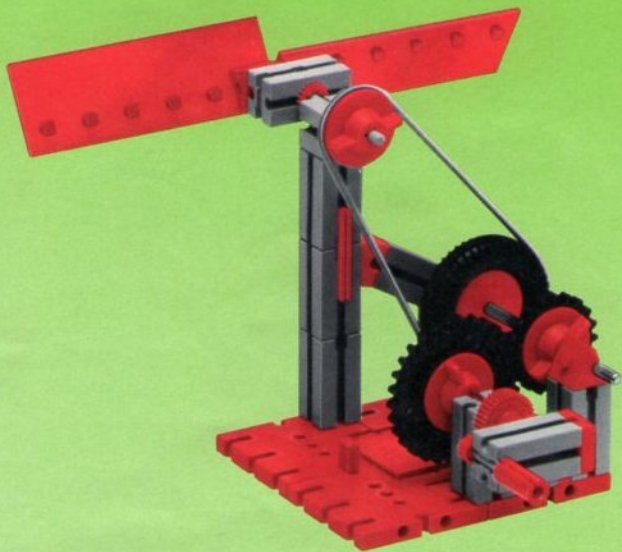

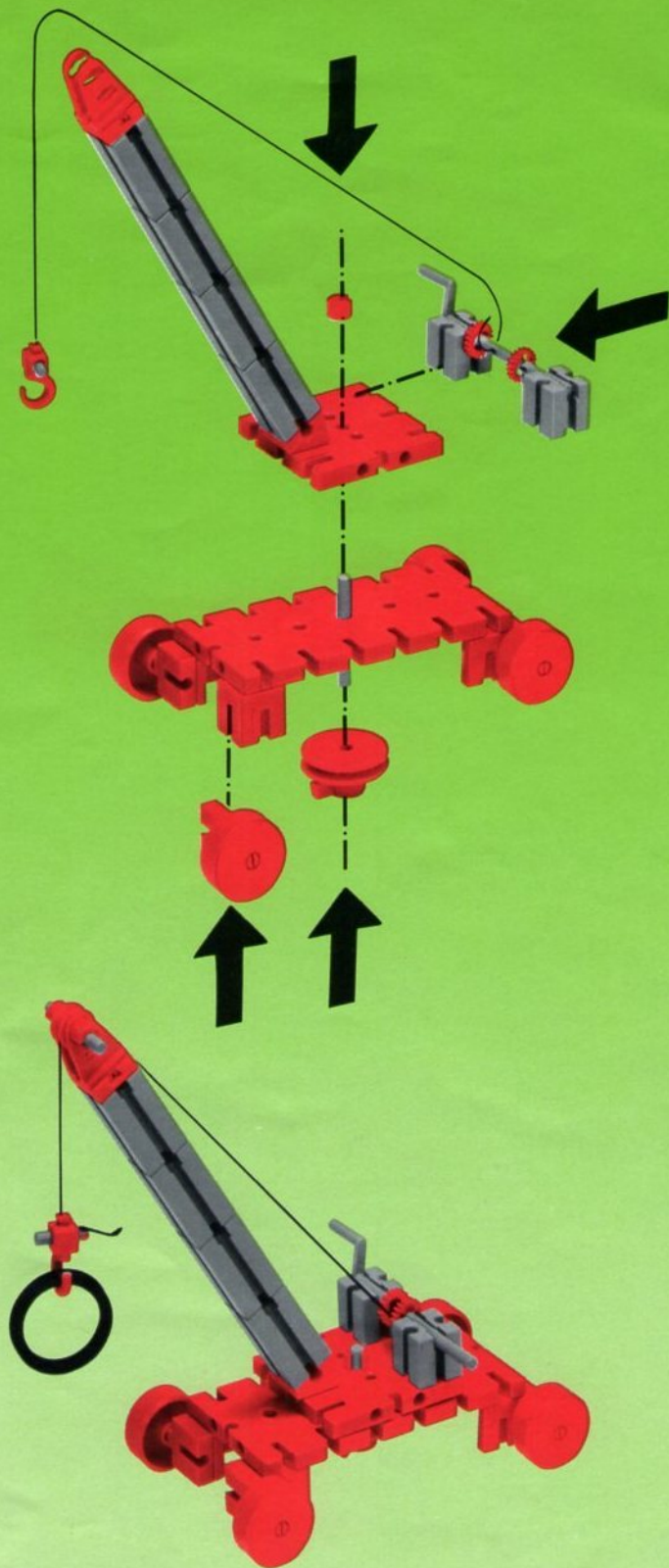





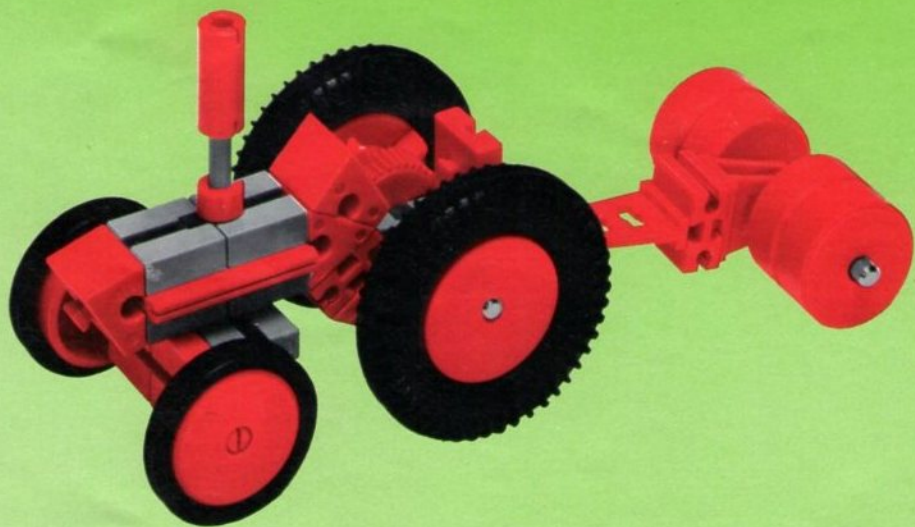
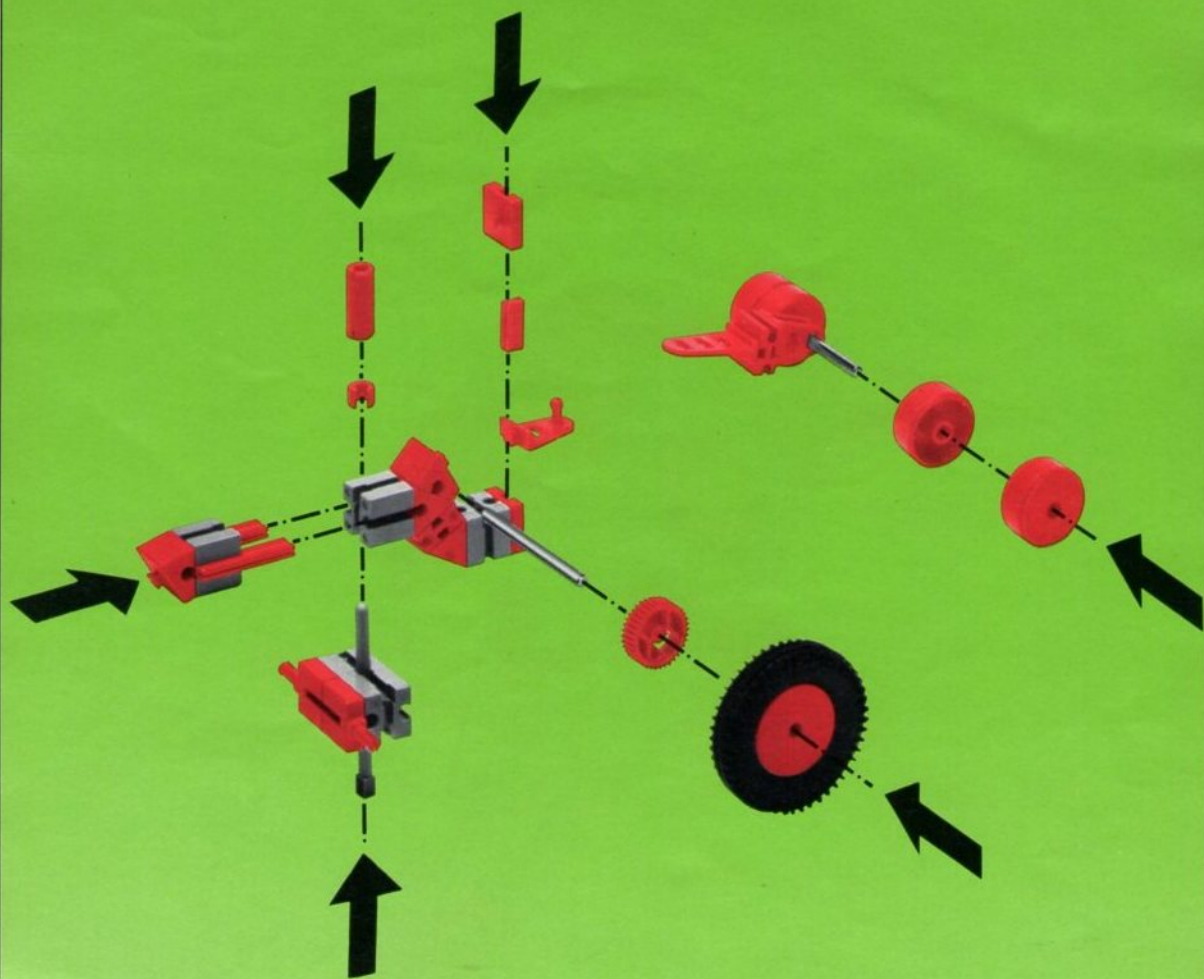



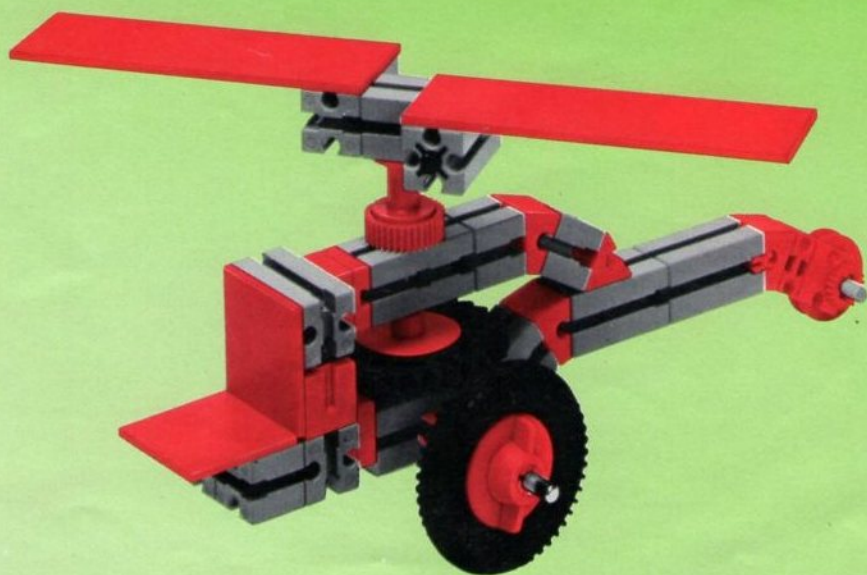
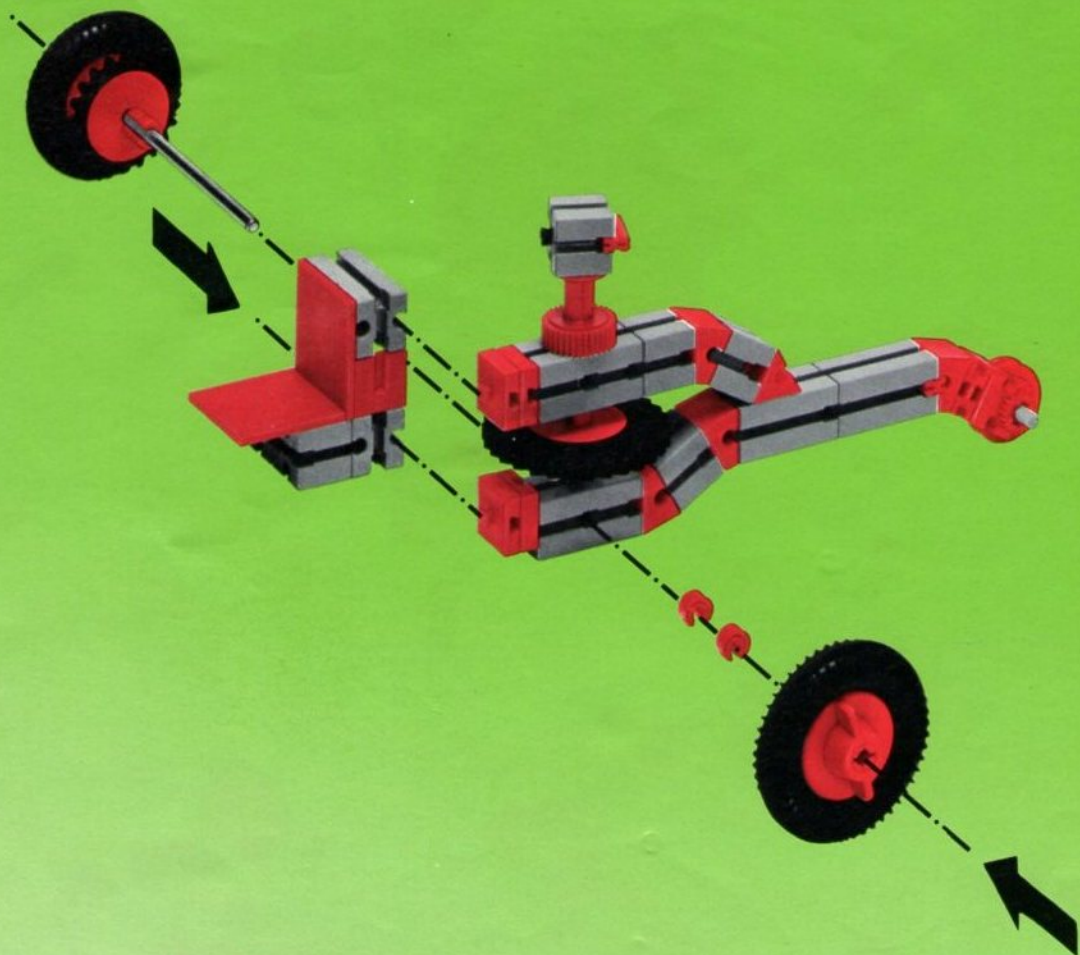

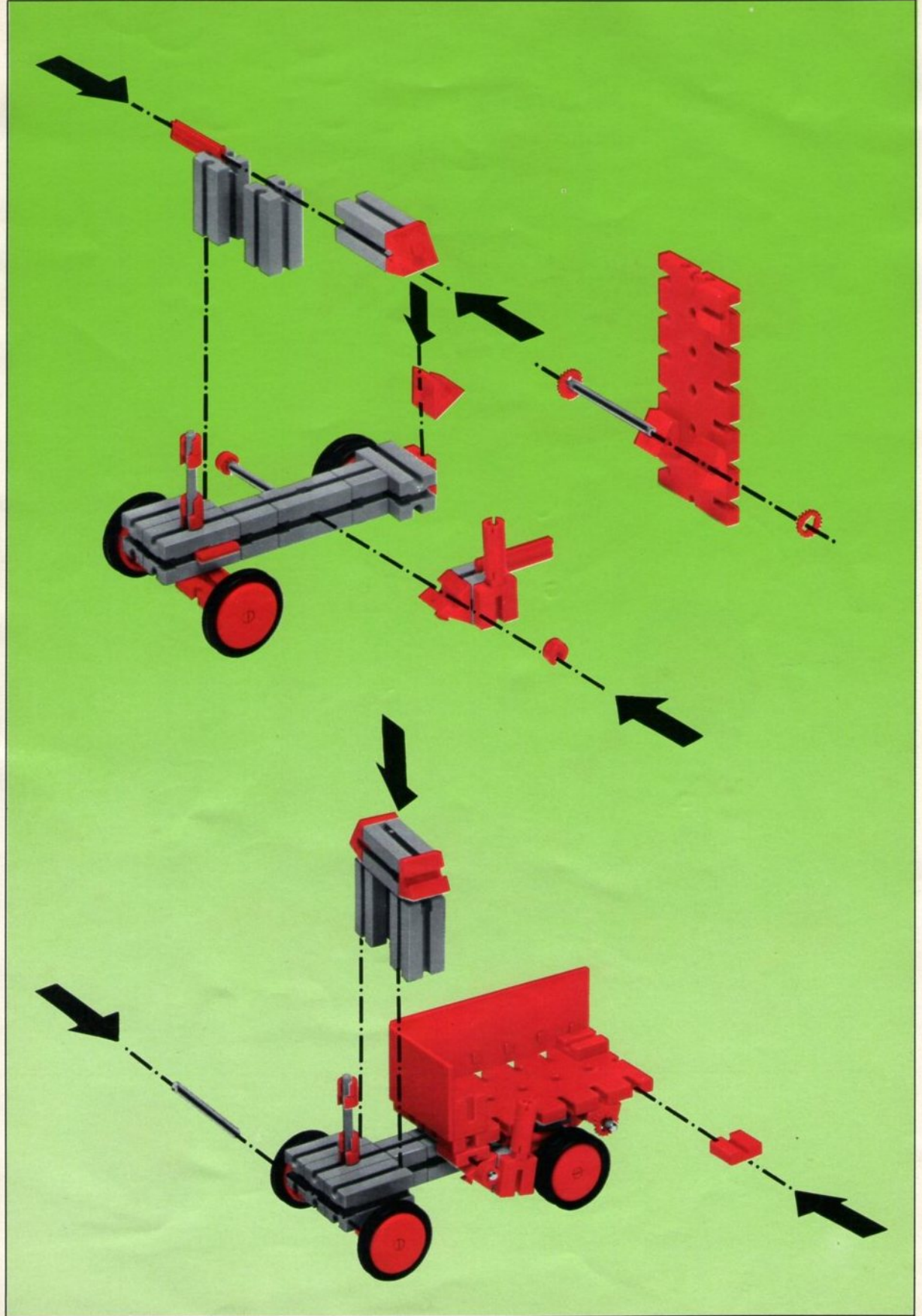





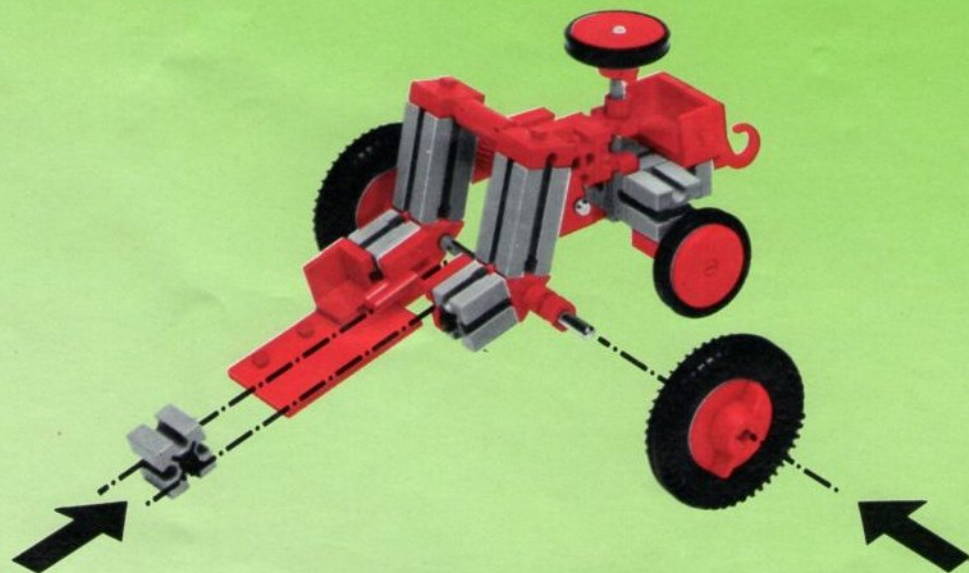
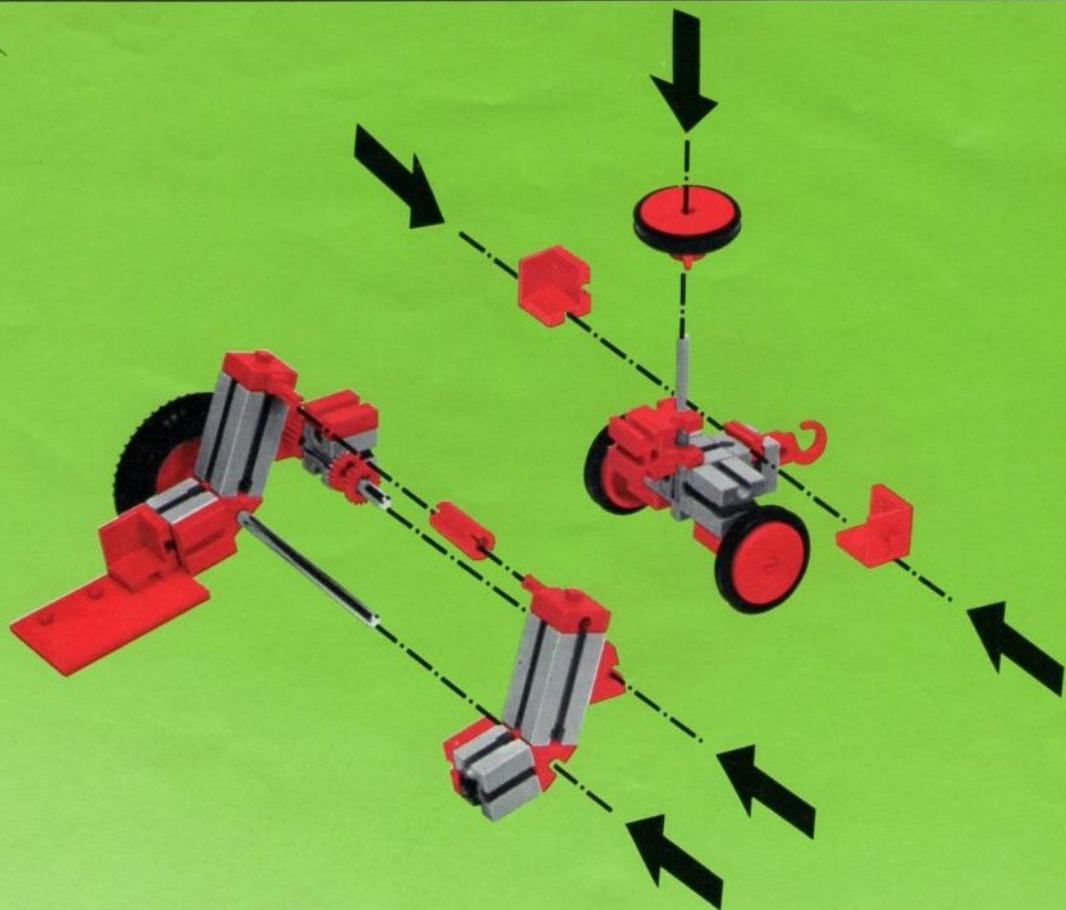





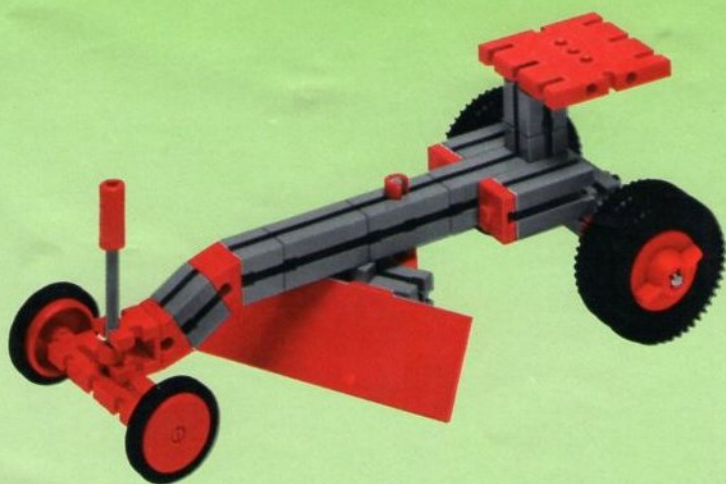
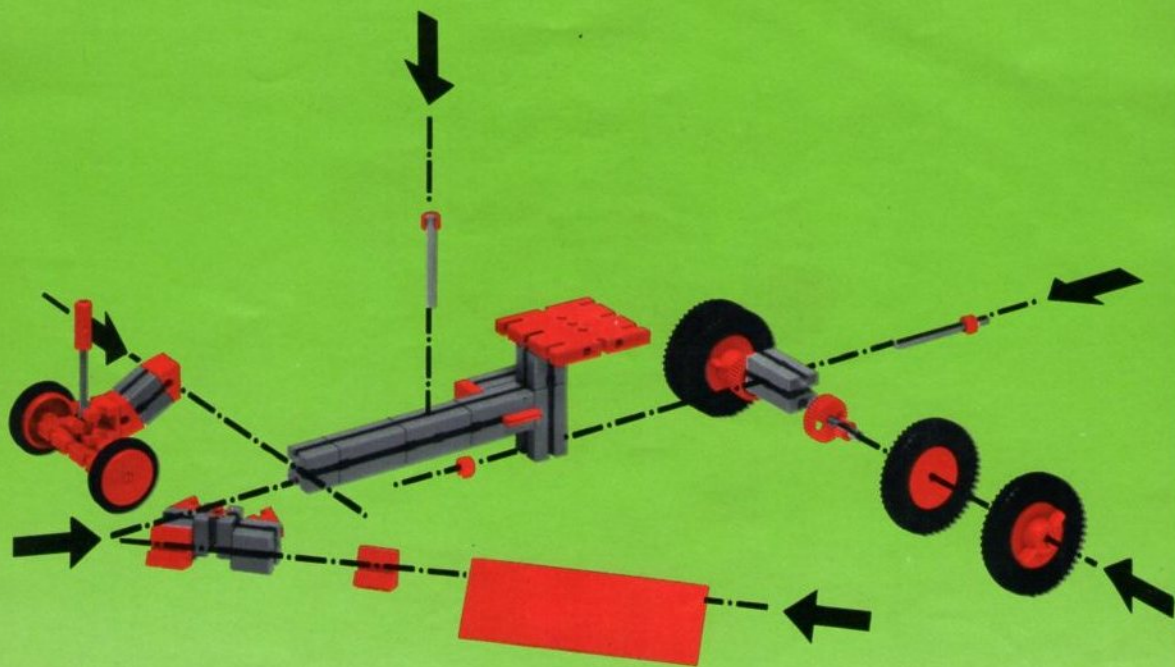



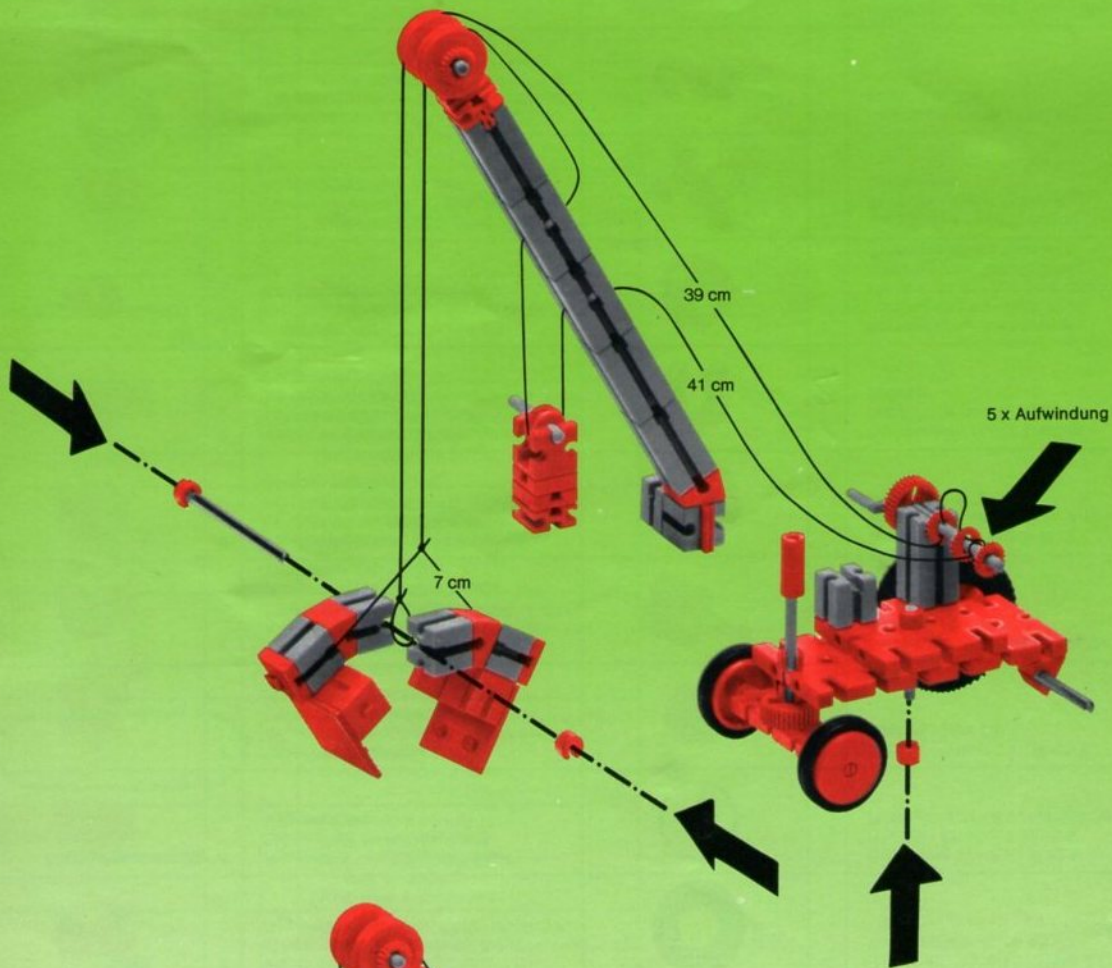



























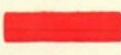



















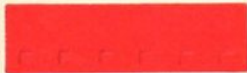



Stückliste · Part List · Nomenclature · Onderdelenlijst · Detalj översikt

	1	Grundplatte 90×45 · Baseplate 90×45 Plaque de base 90×45 · Basisplaat 90×45 · Bottenplatta 90×45 Art.-Nr. 4365761		1	Nylonseil · Nylon line · Ficelle · Nylon draad · Nylonrep  Art.-Nr. 3310271
	2	Grundplatte 45×45 · Baseplate 45×45 Plaque de base 45×45 · Basisplatte 45×45 · Bottenplatta 45×45 Art.-Nr. 4365931		5	Riegelscheibe · Blocking washer · Disque d'arrêt · Grendelschijf · Regelskiva  Art.-Nr. 4363341
	7	Baustein 30 · Building block 30 · Élément de 30 · Bouwsteen 30 · Byggnadssten 30  Art.-Nr. 3310031		6	Klemmbuchse 5 · Spring clip 5 · Baqe de serrage 5 · Klēmbus 5 · Klāmbussning 5  Art.-Nr. 3376791
	2	Baustein 30 mit Bohrung · Building block 30 with bore · Élément de 30 percé · Bouwsteen 30 met boring · Byggnadssten 30 med borrhål Art.-Nr. 3310041		1	Klemmkupplung · Coupling · Manchon d'accouplement · Klemkoppeling · Klām-koppeling  Art.-Nr. 4310241
	6	Baustein 15 · Building block 15 · Élément de 15 · Bouwsteen 15 · Byggnadssten 15  Art.-Nr. 3310051		4	Flachnabe · Flat hub · Moyeu plat · Platte naaf · Plattnav  Art.-Nr. 3310151
	2	Baustein 15 mit rundem Zapfen · Building block 15 with round lug Élément de 15 à tourillon · Bouwsteen 15 met ronde nokken Byggnadssten 15 med runda tappar Art.-Nr. 3310591		6	Reifen 30 · Tyre 30 · Pneu 30 · Wielband 30 · Däck 30  Art.-Nr. 4310171
	2	Baustein 7,5 · Building block 7,5 · Élément de 7,5 · Bouwsteen 7,5 · Byggnadssten 7,5  Art.-Nr. 4374681		4	Reifen 45 · Tyre 45 · Pneu 45 · Wielband 45 · Däck 45  Art.-Nr. 4310181
	4	Baustein 5 · Building block 5 · Élément de 5 · Bouwsteen 5 · Byggnadssten 5  Art.-Nr. 4372371		2	Gummiring 37×2,5 · Rubber ring 37×2,5 · Elastique 37×2,5 · Rubbering 37×2,5 · Gummiring 37×2,5  Art.-Nr. 4360517
	2	Winkelstein gleichseitig · Angle block, equilateral · Élément angulaire équilateral · Hoeksteen · Vinkelsten, liksidig Art.-Nr. 4310101		6	Rad 23 · Wheel 23 · Roue 23 · Wiel 23 · Hjul 23  Art.-Nr. 4365811
	4	Winkelstein gleichschenkelig · Angle block, isosceles · Élément angulaire isocèle · Hoeksteen met gelijke benen · Vinkelsten, rätvinklig Art.-Nr. 4310111		4	Radachse · Stub axle · Axe de roue · Wiel as · Hjul axel  Art.-Nr. 4365861
	6	Verbindungsstück 15 · Connector 15 · Languette d'assemblage 15 · Verbindingsstuk 15 · Förbindningsstycke 15 Art.-Nr. 4310601		2	Seilrolle Ø 21 · Pulley Ø 21 Poulie Ø 21 · Snaarschijf Ø 21 Lintrumma Ø 21  Art.-Nr. 4357951
	2	Verbindungsstück 30 · Connector 30 · Languette d'assemblage 30 · Verbindingsstuk 30 · Förbindningsstycke 30 Art.-Nr. 4310611		1	Rollenlager · Roller bearing · Support de poulie · Rollager · Rullager  Art.-Nr. 4376361
	1	Kupplungsstück 1 · Coupling 1 · Élément d'attelage 1 · Koppelstuk 1 · Kopplingsselement 1  Art.-Nr. 4382541		2	Klemmring für Seiltrommel · Locking ring for winch drum · Flasque de serrage pour tambour · Klemring voor kabeltrommel · Stopping till lintrumma Art.-Nr. 4310201
	2	Kupplungsstück 2 · Coupling 2 · Élément d'attelage 2 · Koppelstuk 2 · Kopplingsselement 2  Art.-Nr. 4382531		1	Seiltrommel · Winch drum · Tambour · Kabel trommel · Linktrumma  Art.-Nr. 4310161
	2	Kupplungsstück 30 · Coupling 30 · Élément d'attelage 30 · Koppelstuk 30 Kopplingsselement 30  Art.-Nr. 4382601		1	Seilhaken · Hook · Crochet · Haak · Linkrok  Art.-Nr. 4382251
	1	Lenkbalken · Link beam · Train avant · Stuurbalk · Styrbalk  Art.-Nr. 4384181		1	Handkurbel · Crank · Manivelle · Handkruk · Handvev  Art.-Nr. 4310261



Stückliste · Part List · Nomenclature · Onderdelenlijst · Detalj översikt

	1	Zahnrad Z 20 · Gearwheel Z 20 · Roue à 20 dents · Tandwiel Z 20 · Kuggjul Z 20  Art.-Nr. 4384761
	1	Zahnrad Z 30 · Gearwheel Z 30 · Couronne à 30 dents m 1,5 · Tandwiel Z 30 · Kuggjul Z 30  Art.-Nr. 4384771
	1	Seilrolle Ø 12 · Pulley Ø 12 · Poulie Ø 12 · Snaarschijf Ø 12 · Lintrumma Ø 12  Art.-Nr. 4382551
	1	Kurbel 60 · Crankshaft 60 · Manivelle grise 60 · Kruk 60 · Vev 60  Art.-Nr. 4382391
	2	Bauplatte 30×90 · Building plate 30×90 · Plaque à tenons 30×90 · Bouwplaat 30×90 · Byggnadsplatta 30×90 Art.-Nr. 4382511
	2	Bauplatte 30×45 · Building plate 30×45 · Plaque à tenons 30×45 · Bouwplaat 30×45 · Byggnadsplatta 30×45 Art.-Nr. 4382481
	2	Bauplatte 30×30 · Building plate 30×30 · Plaque à tenons 30×30 · Bouwplaat 30×30 · Byggnadsplatta 30×30 Art.-Nr. 4382591
	1	Antriebsfeder 270 · Drive spring 270 · Ressort de transmission 270 · Aandrijfveer 270 · Drivande fjäder 270 Art.-Nr. 4310287
	1	Achse mit 4-Kantansatz · Axle with square end · Axe gris à embout carré · As met 4-kantnok · Art.-Nr. Axel med 4-kantskarv 4384121
	1	Seilklemmstift 4×15 · Cord clamp 4×15 · Segment de blocage 4×15 · Draadklem 4×15 · Stift till kabelklämma 4×15 Art.-Nr. 4382261
	4	Kunststoffachse 30 · Plastic axle 30 · Axe gris 30 · K-as 30 · Axel av syntetmaterial 30  Art.-Nr. 4384131
	4	Baustein V-15-Eck · Building block V 15 corner · Pierre V 15 d'angle · Hoekbouwsteen V 15 · Hörnbyggsten V 15 Art.-Nr. 4382401
	2	Achse 110 · Axle 4 1/4" approx. · Axe 110 · As 110 · Axel 110  Art.-Nr. 4310313
	1	Achse 80 · Axle 3" approx. · Axe 80 · As 80 · Axel 80  Art.-Nr. 4373843
	1	Achse 60 · Axle 2 1/2" approx. · Axe 60 · As 60 · Axel 60  Art.-Nr. 4310323
	2	Achse 50 · Axle 2" approx. · Axe 50 · As 50 · Axel 50  Art.-Nr. 4310333



