

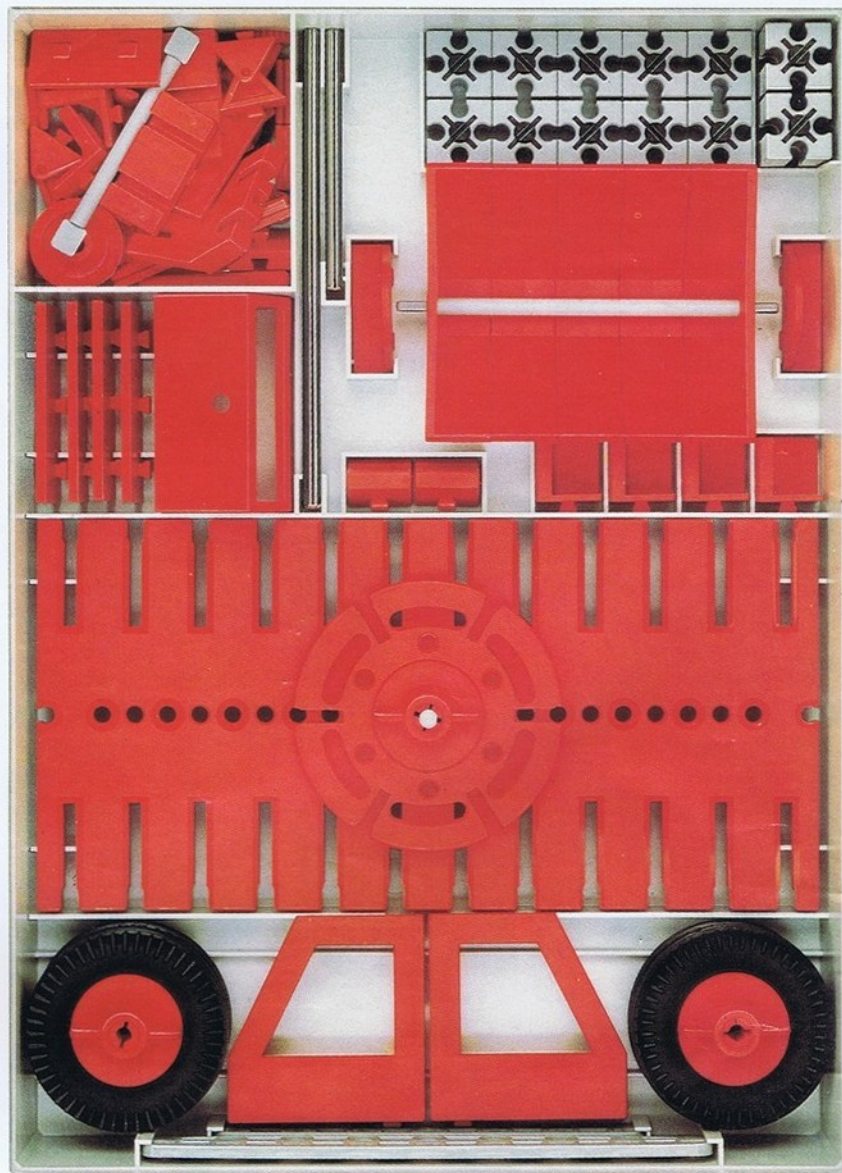

Start

fischertechnik®

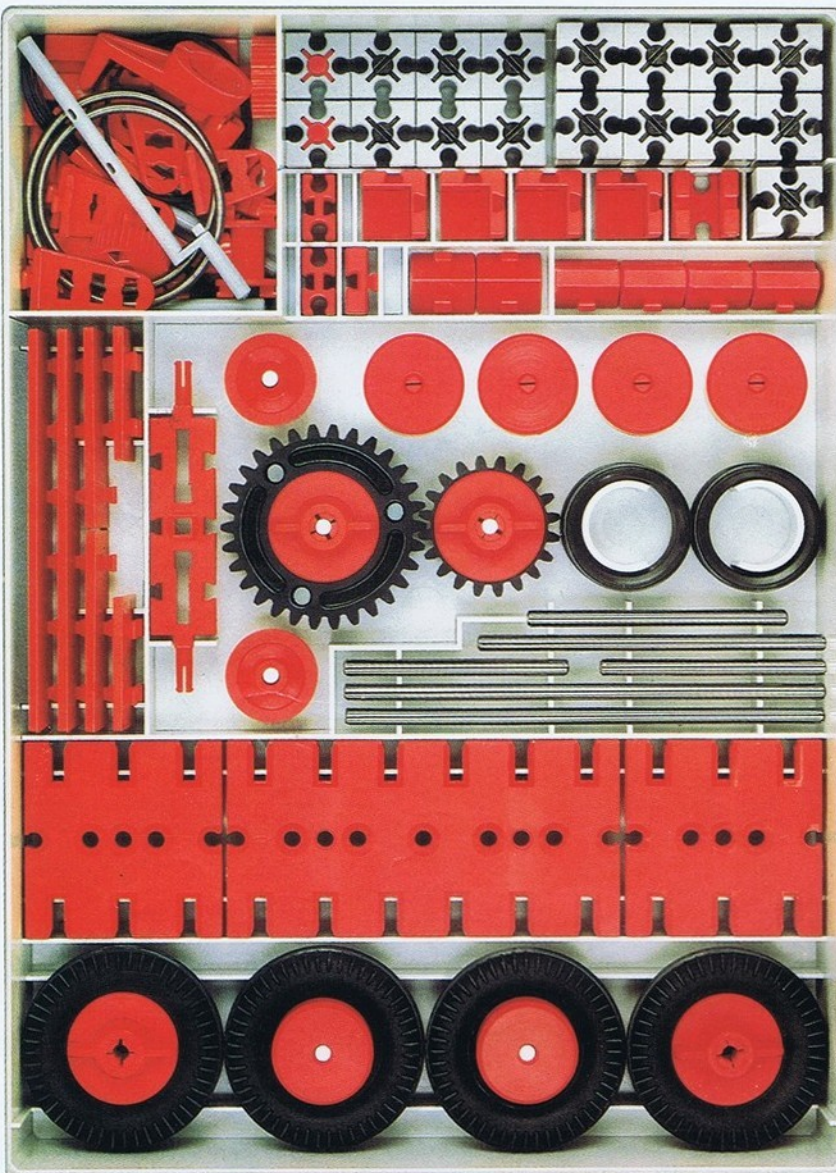



Start 100

Start 200



fischertechnik beginnt mit Start 100 (100 verschiedene Modelle) oder Start 200 (200 verschiedene Modelle).

Start 100 wird erweitert durch Start 100/1 (50/2) auf Start 200.

Start 200 wird erweitert durch Start 200/1 (50/3). Es ergeben sich viele neue interessante Baumöglichkeiten.



fischertechnik begins with either "Start 100" (100 different models) or "Start 200" (200 different models).

"Start 100" may be converted into "Start 200" by using "Start 100/1" (50/2).

"Start 200" may be converted using "Start 200/1" (50/3). Many new and interesting construction ideas result.



fischertechnik débute avec «Start 100» (100 modèles différents) ou «Start 200» (200 modèles différents).

«Start 100» peut se compléter en version «Start 200» moyennant «Start 100/1» (50/2).

«Start 200» peut se compléter moyennant «Start 200/1» (50/3). Il en résulte de nombreuses nouvelles possibilités de construction particulièrement intéressantes.



fischertechnik begint met „Start 100“ (100 verschillende modellen) of „Start 200“ (200 verschillende modellen).

„Start 100“ kan door „Start 100/1“ (50/2) uitgebreid worden.

„Start 200“ kan door „Start 200/1“ (50/3) uitgebreid worden. Daardoor ontstaan talloze nieuwe bouw mogelijkheden.

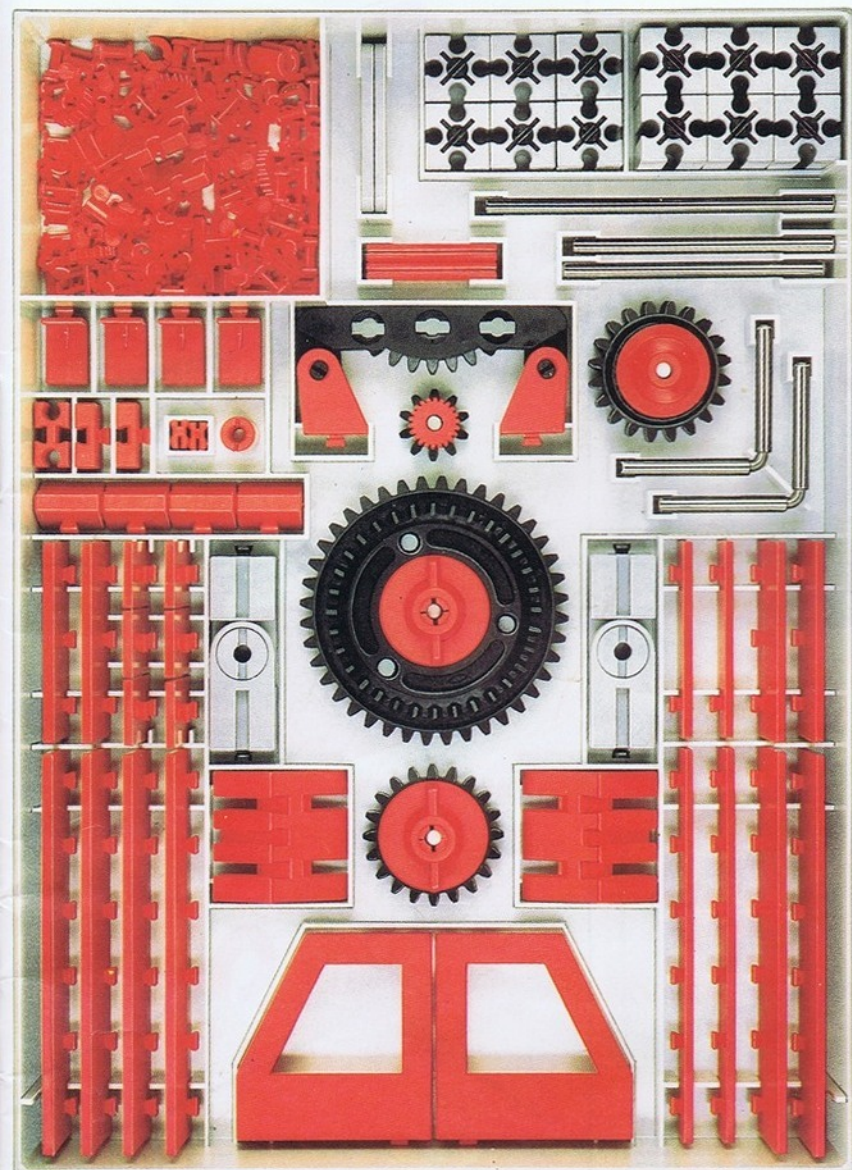

Start 100/1 (50/2)

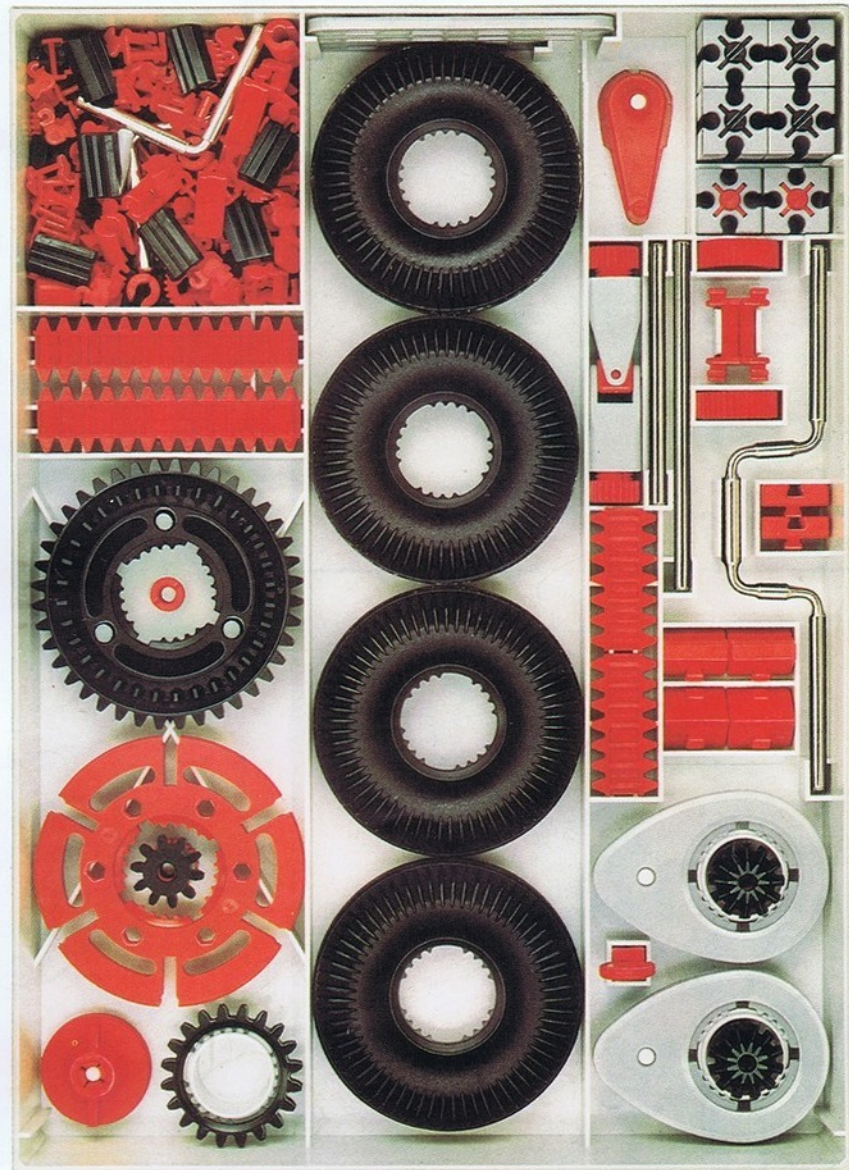

Start 200/1 (50/3)



fischertechnik comienza con «Start 100» (100 modelos diferentes) o con «Start 200» (200 modelos diferentes).

«Start 100» puede ser ampliado por «Start 100/1» (50/2) a «Start 200».

«Start 200» puede ser ampliado por «Start 200/1» (50/3). La caja ofrece muchas nuevas posibilidades de construcción muy interesantes.



Il gioco fischertechnik ha inizio con: «Start 100» (100 diversi modelli) oppure «Start 200» (200 diversi modelli).

Aggiungendo allo «Start 100» la cassetta di ampliamento «Start 100/1» (50/2) si compone lo «Start 200».

Lo «Start 200» può essere ulteriormente perfezionato con la cassetta «Start 200/1» (50/3) per avere molte altre possibilità di costruzione.



fischertechnik börjar med »Start 100» (100 olika modeller) eller »Start 200» (200 olika modeller).

»Start 100» bygges ut med »Start 100/1» (50/2) till »Start 200».

»Start 200» bygges ut med »Start 200/1» (50/3). Det ger många nya intressanta byggmöjligheter.



200

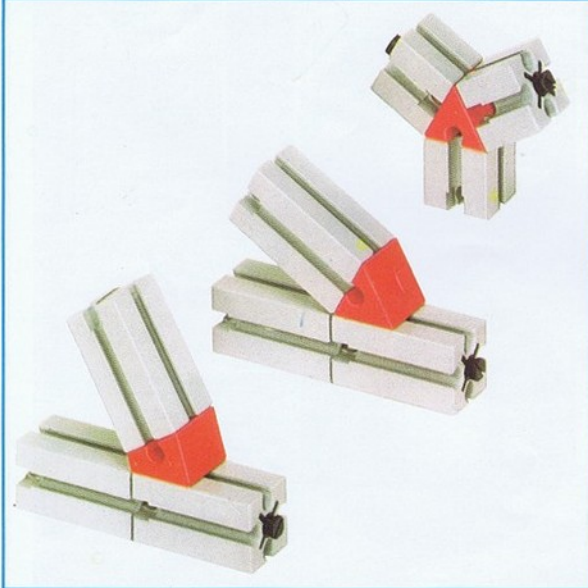
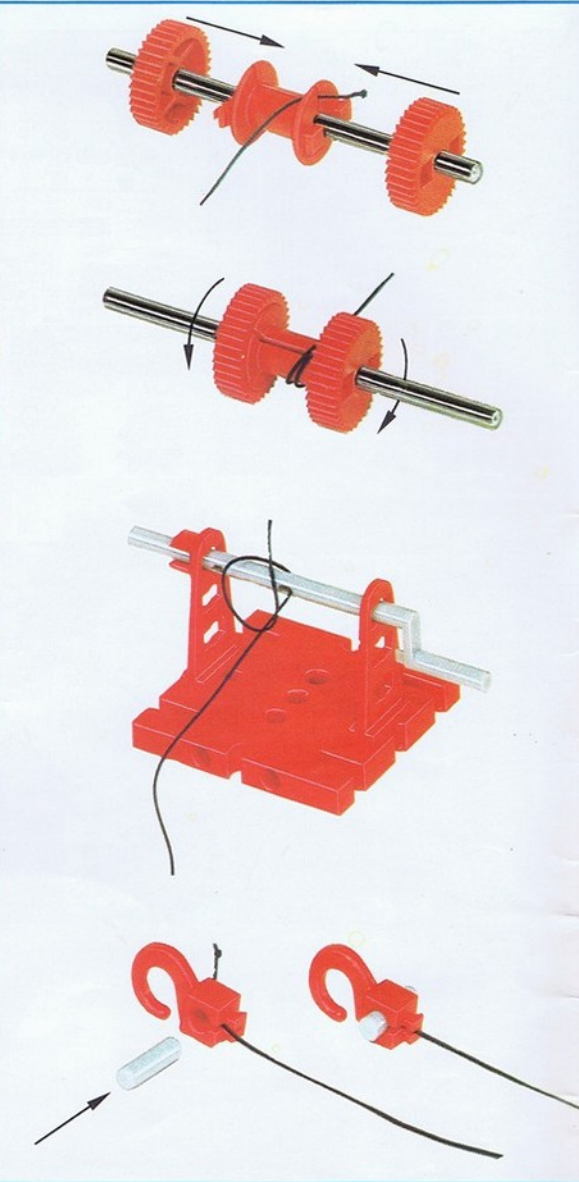
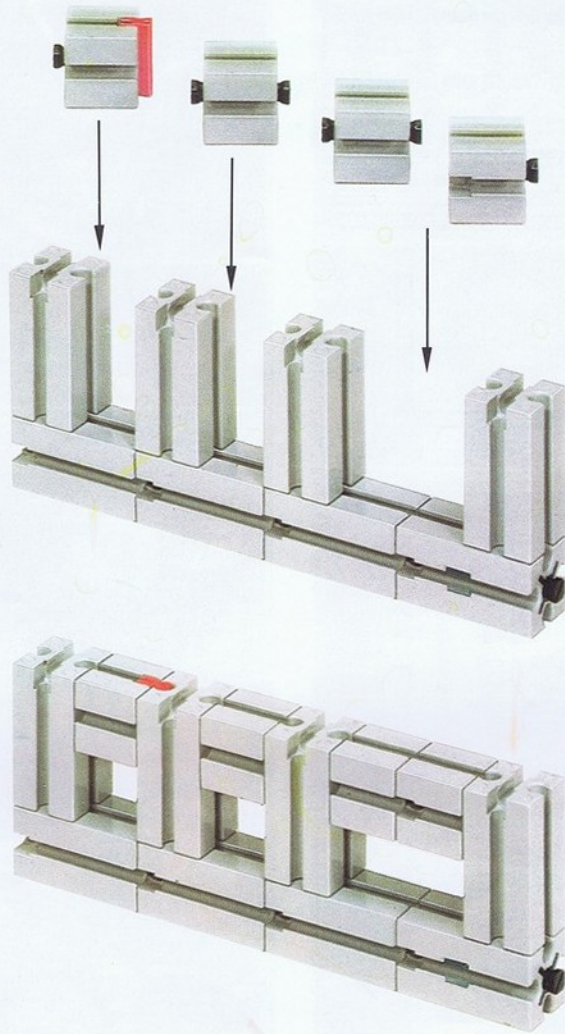

200

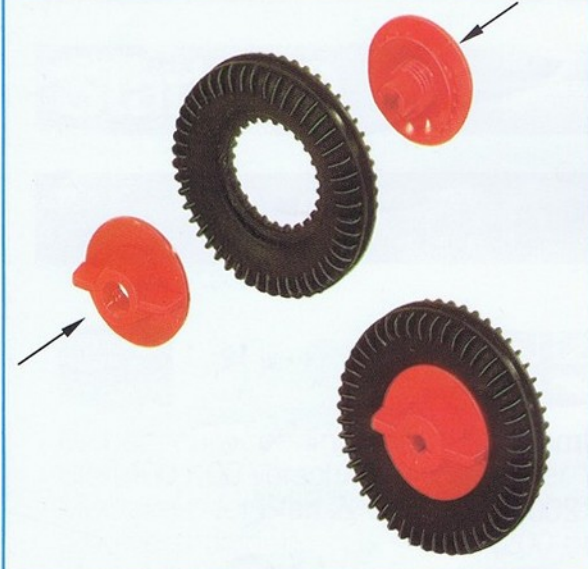
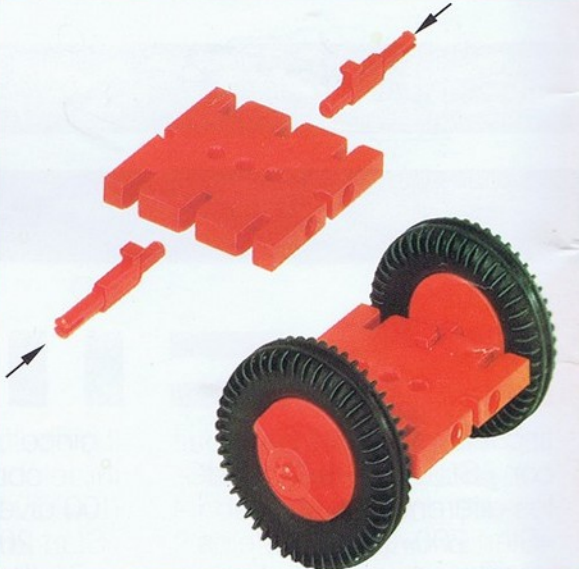
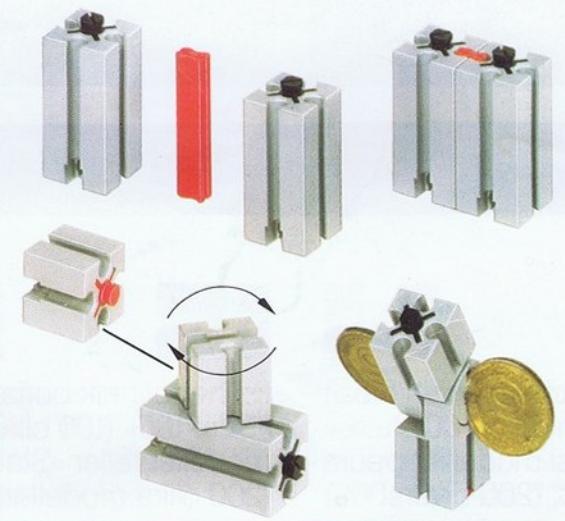

200/1

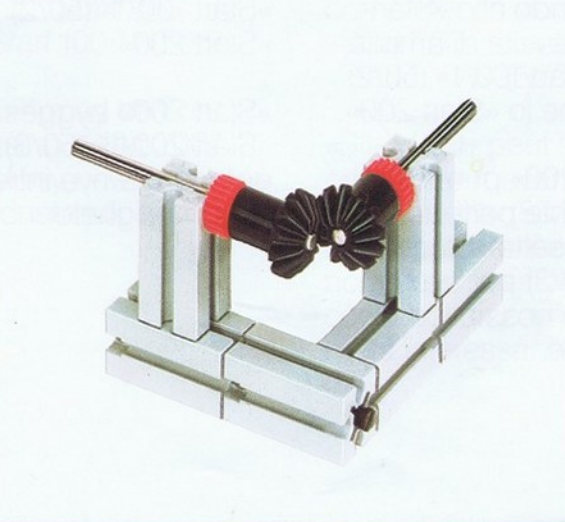

200/1

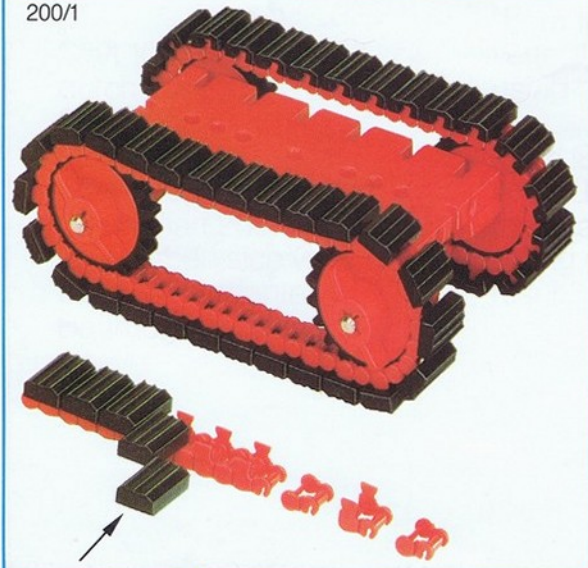
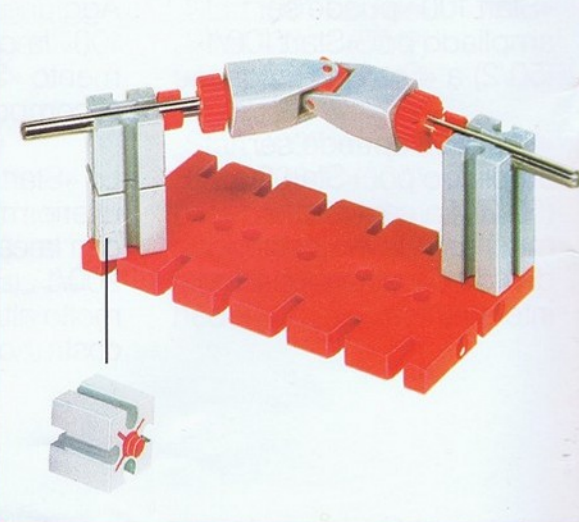

Start

Handhabung · Handling · Mode d'emploi · Gebruiksaanwijzing · Manipulación · Istruzioni di montaggio · Handledning

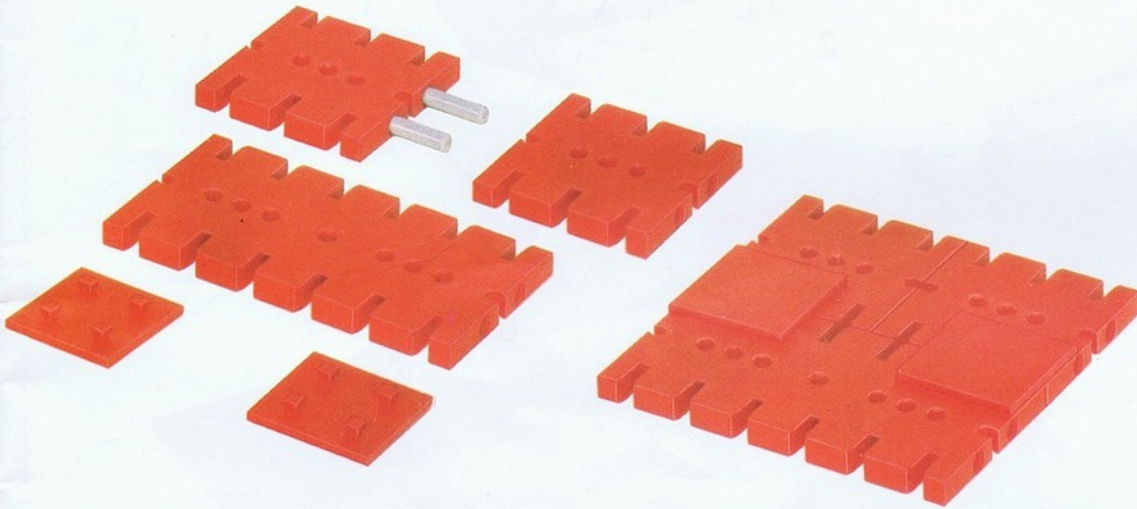
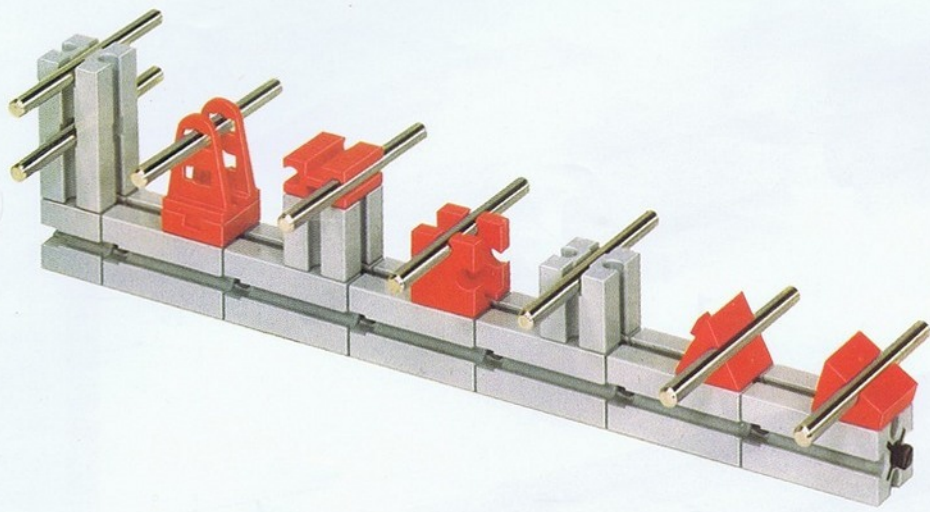

200



200

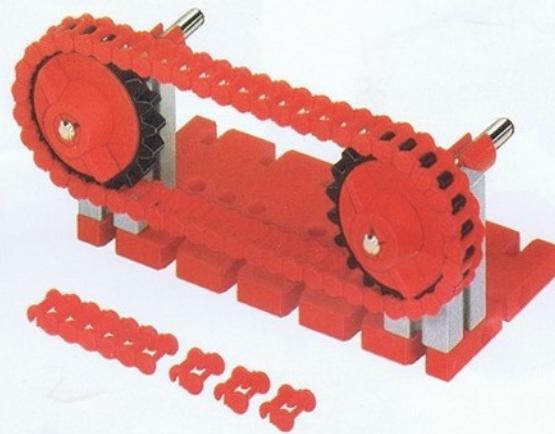

200/1

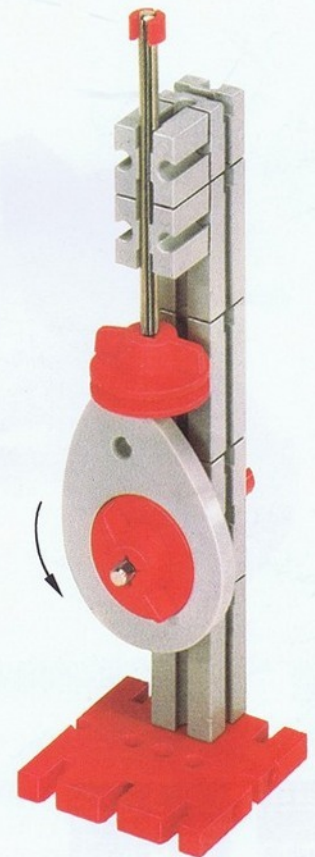

200/1

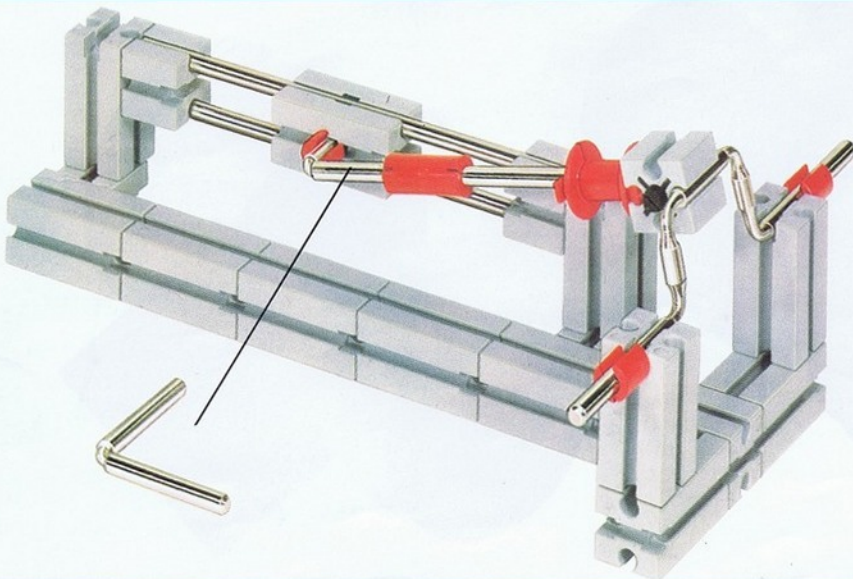

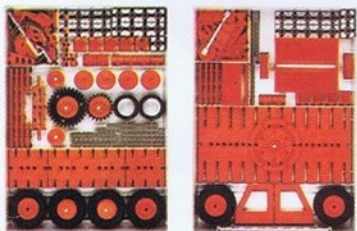
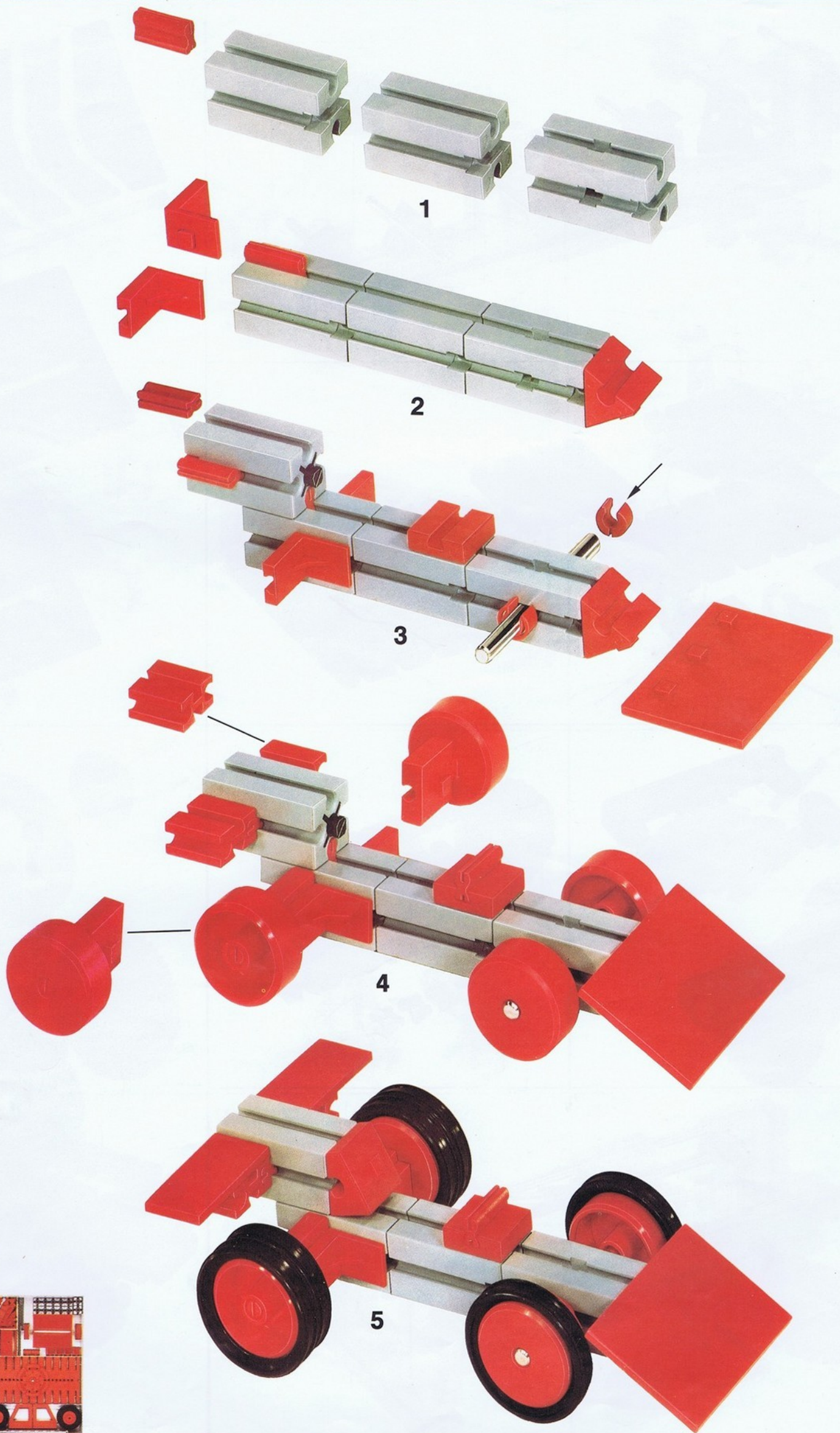

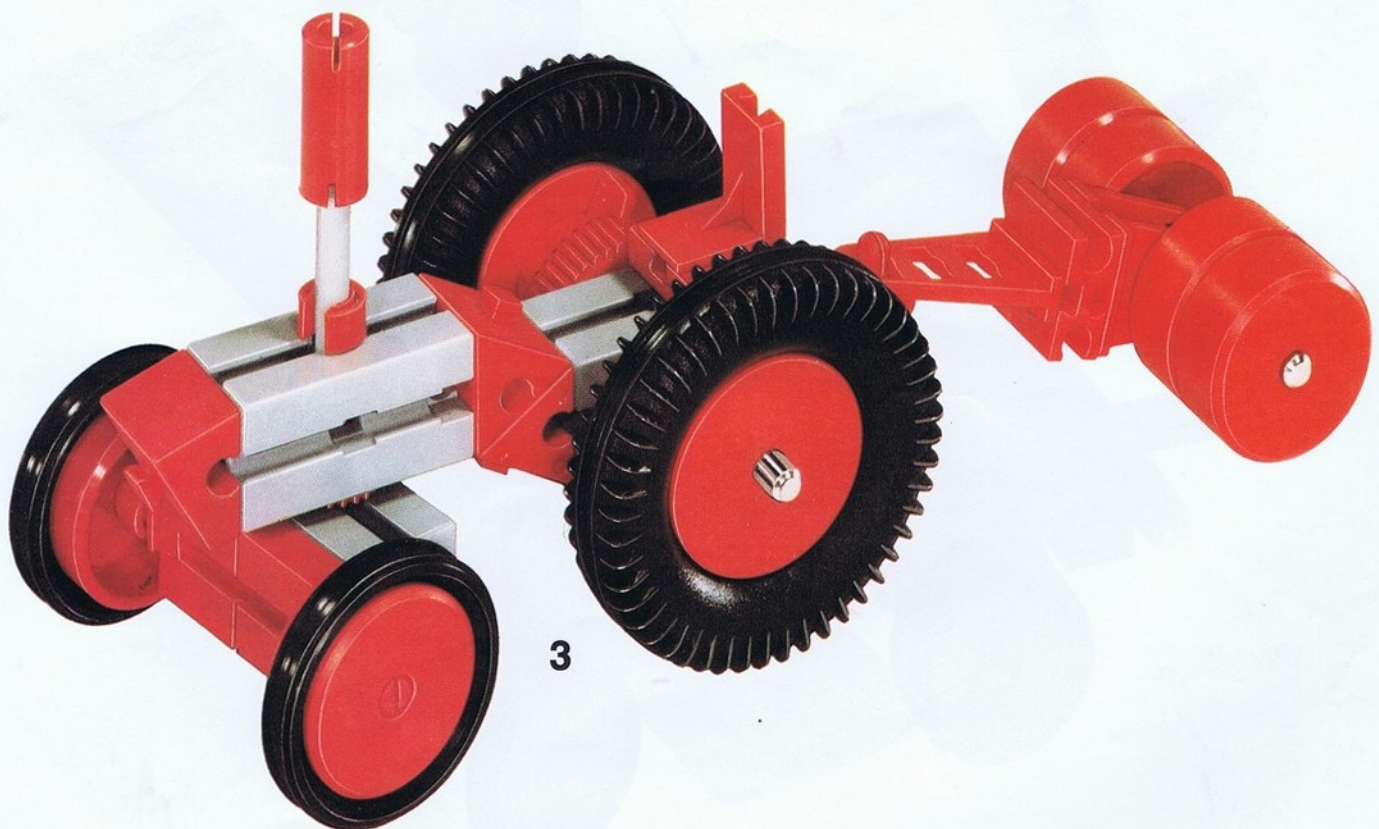
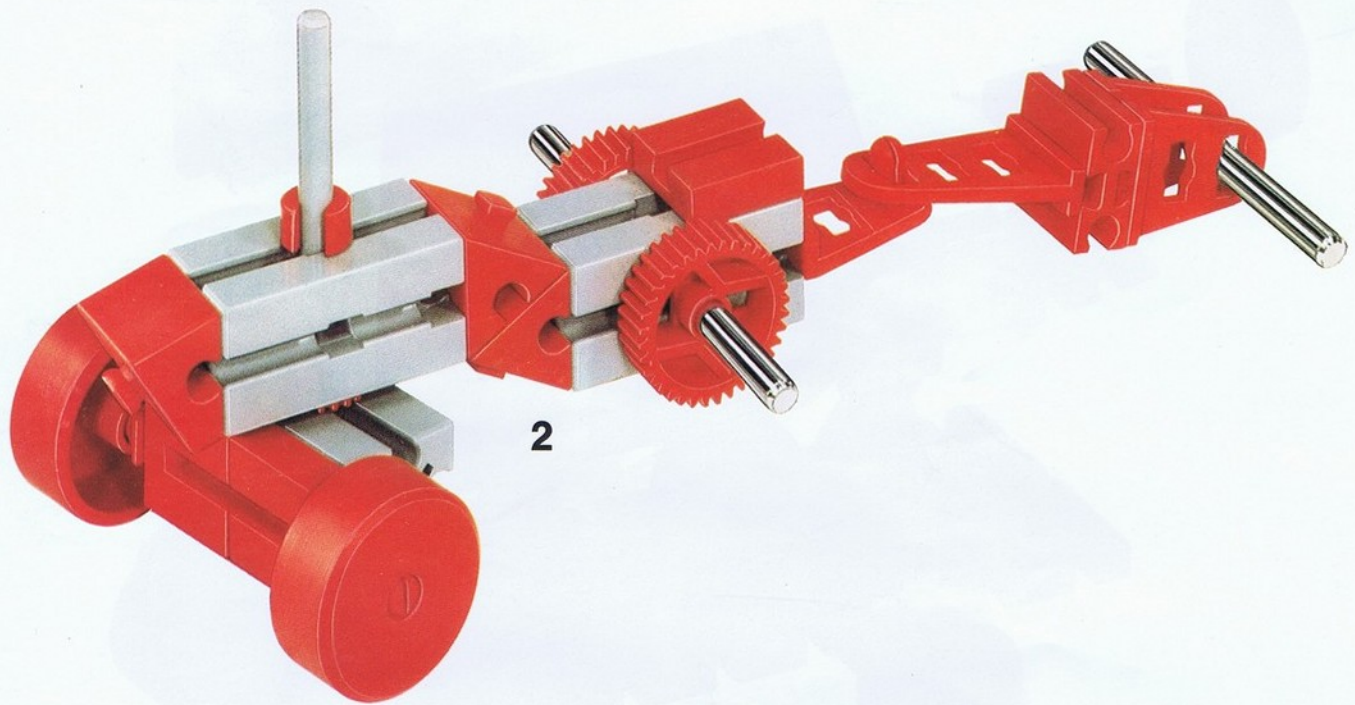
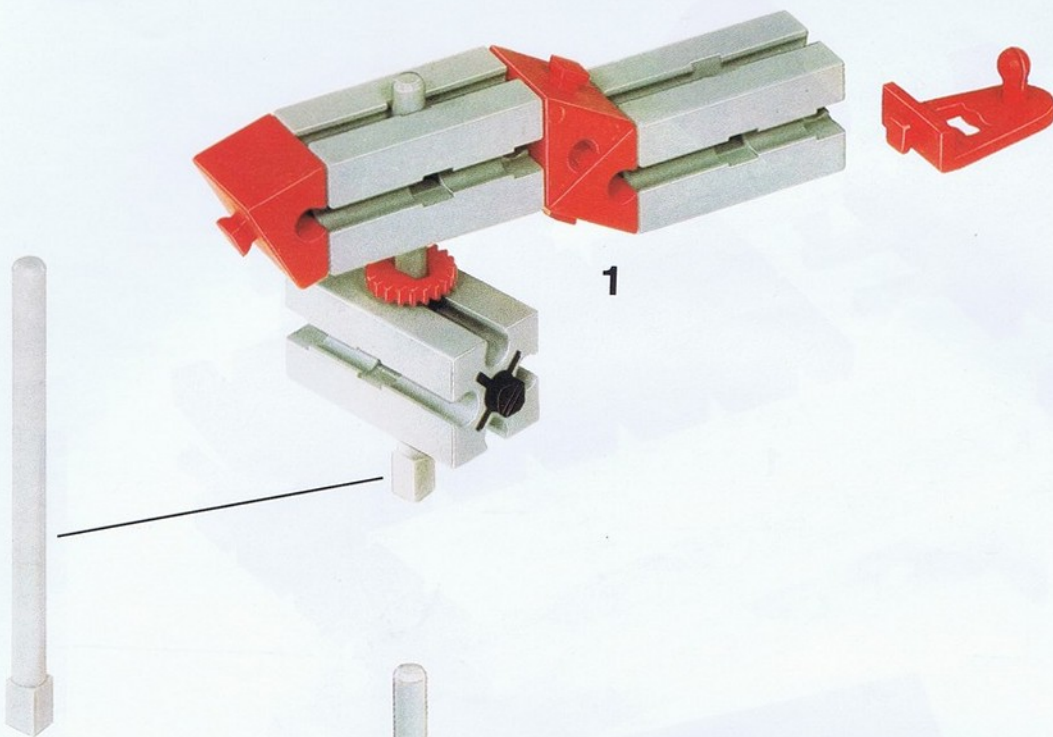

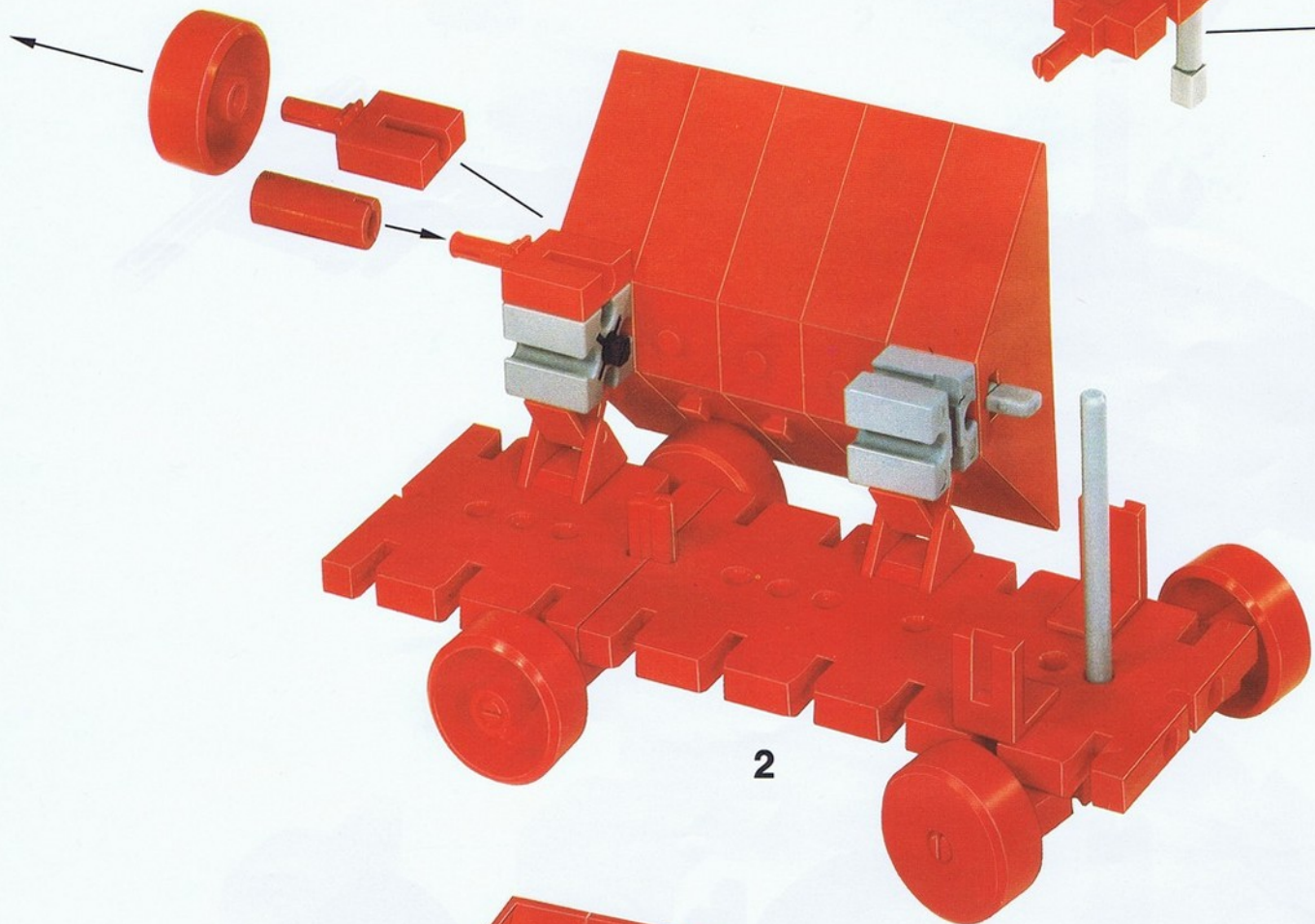
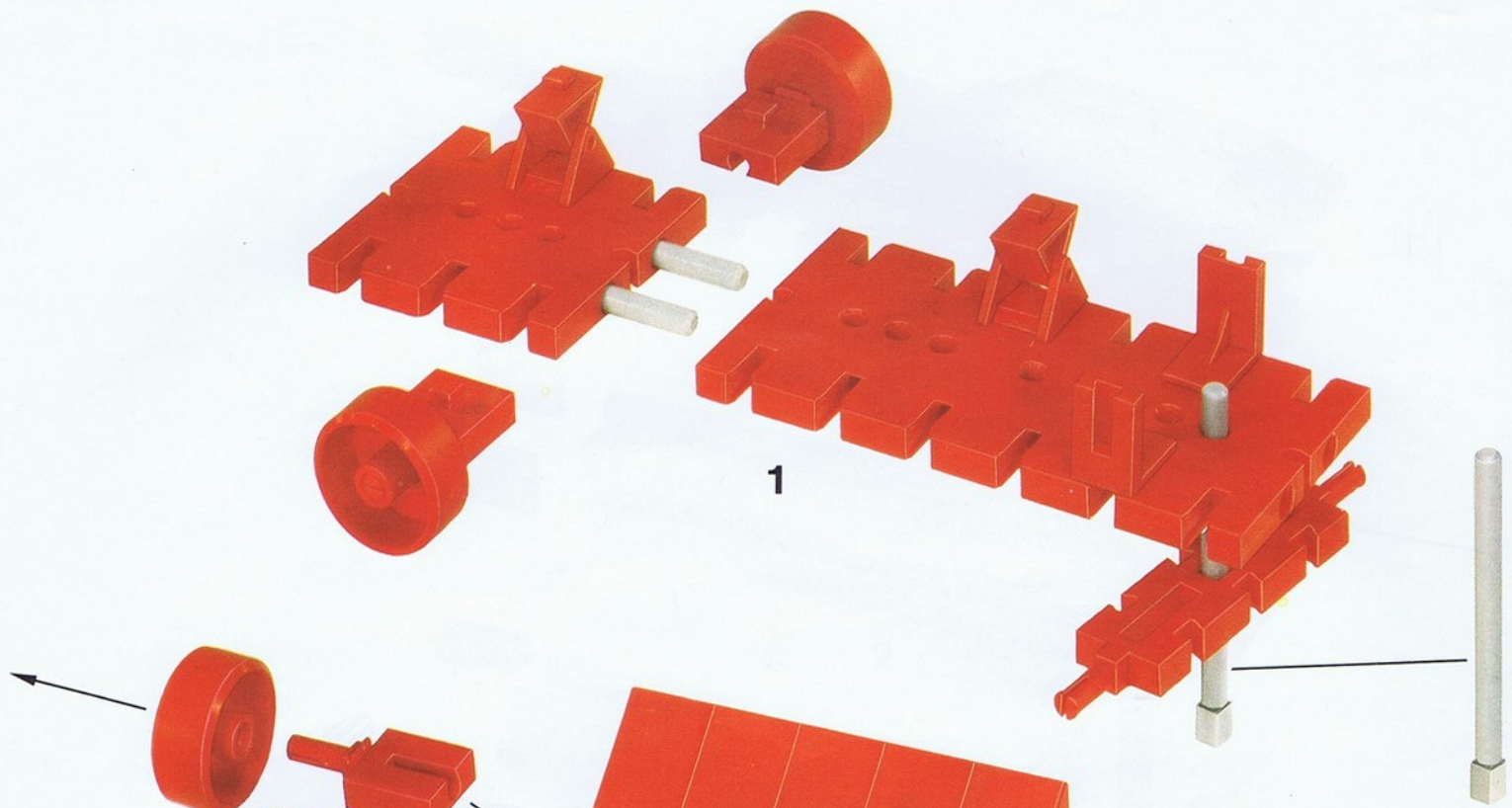

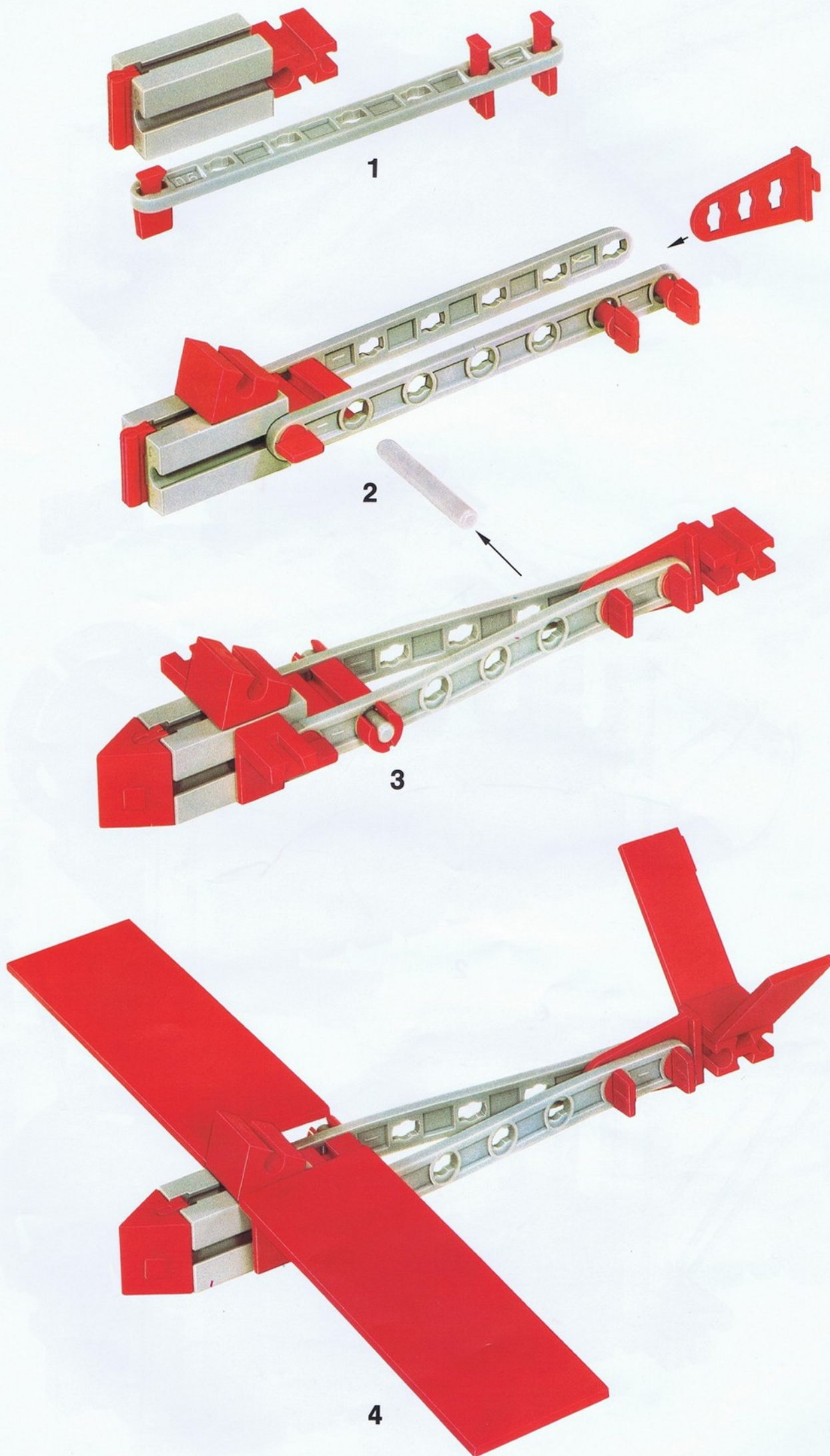

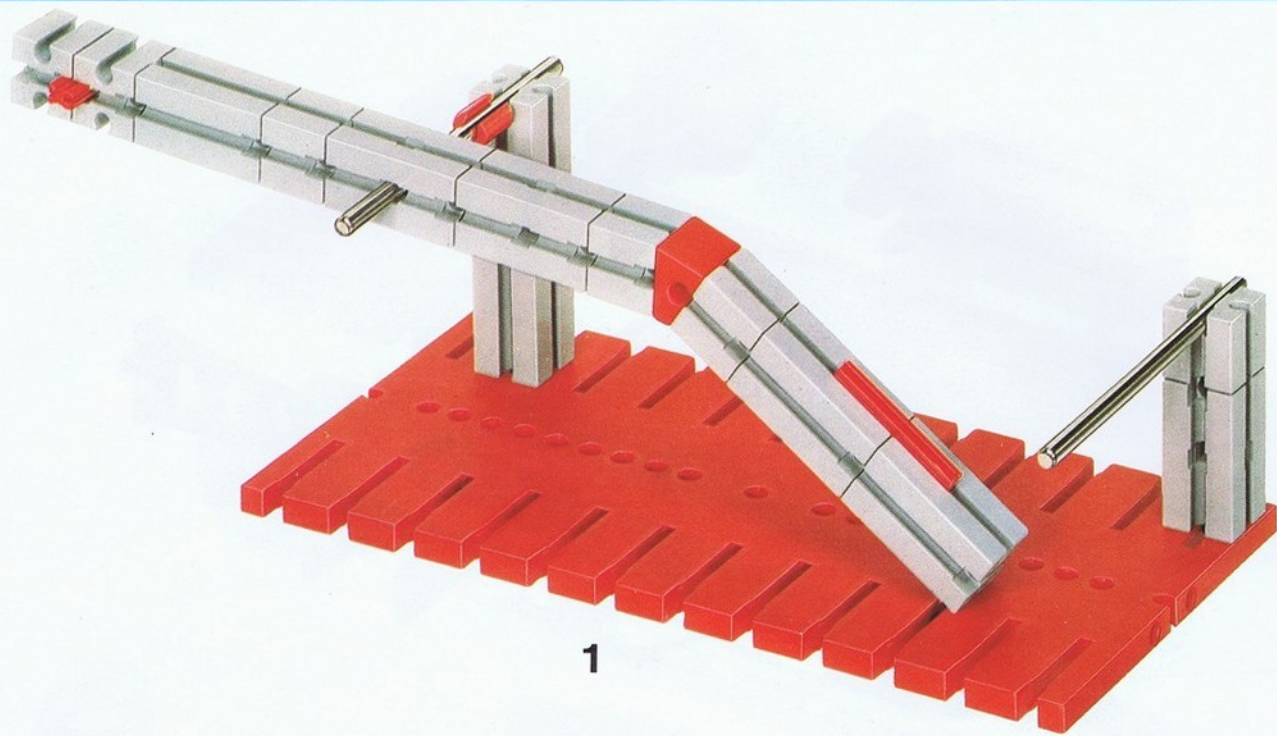

1

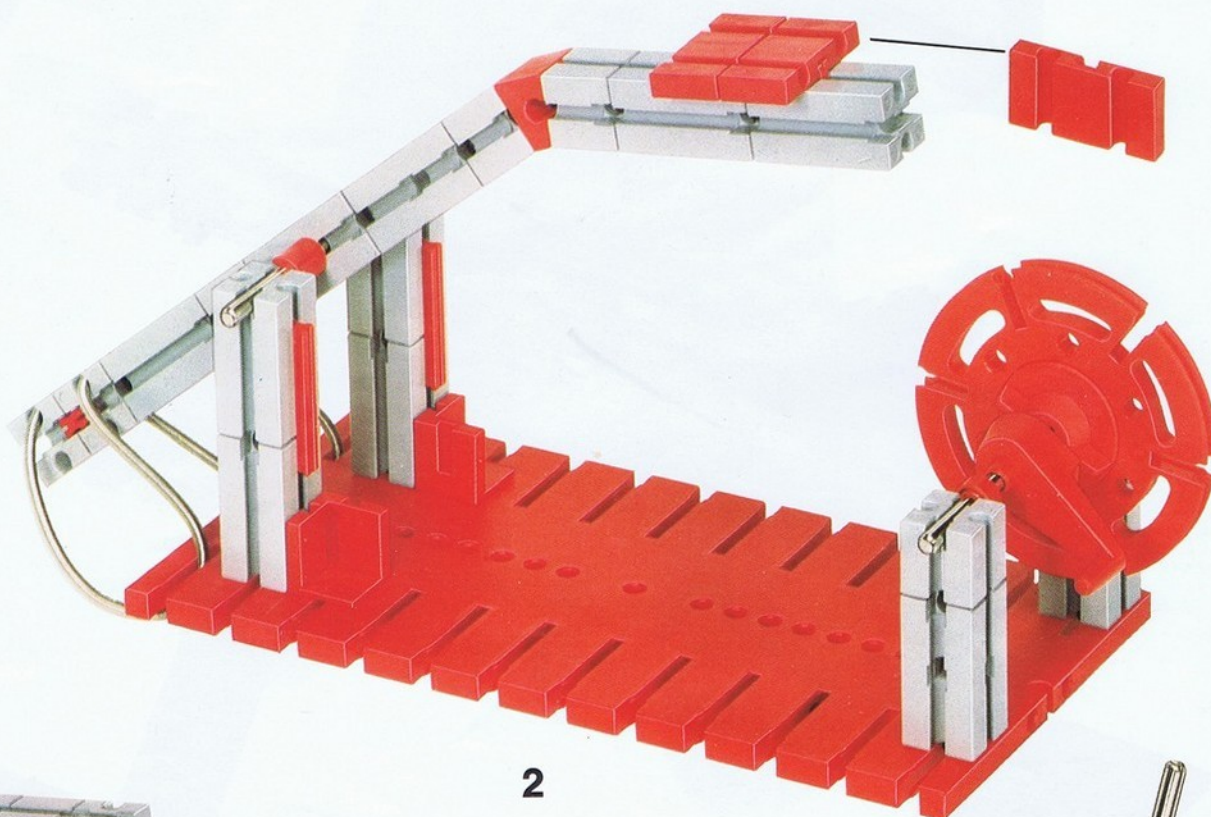

2

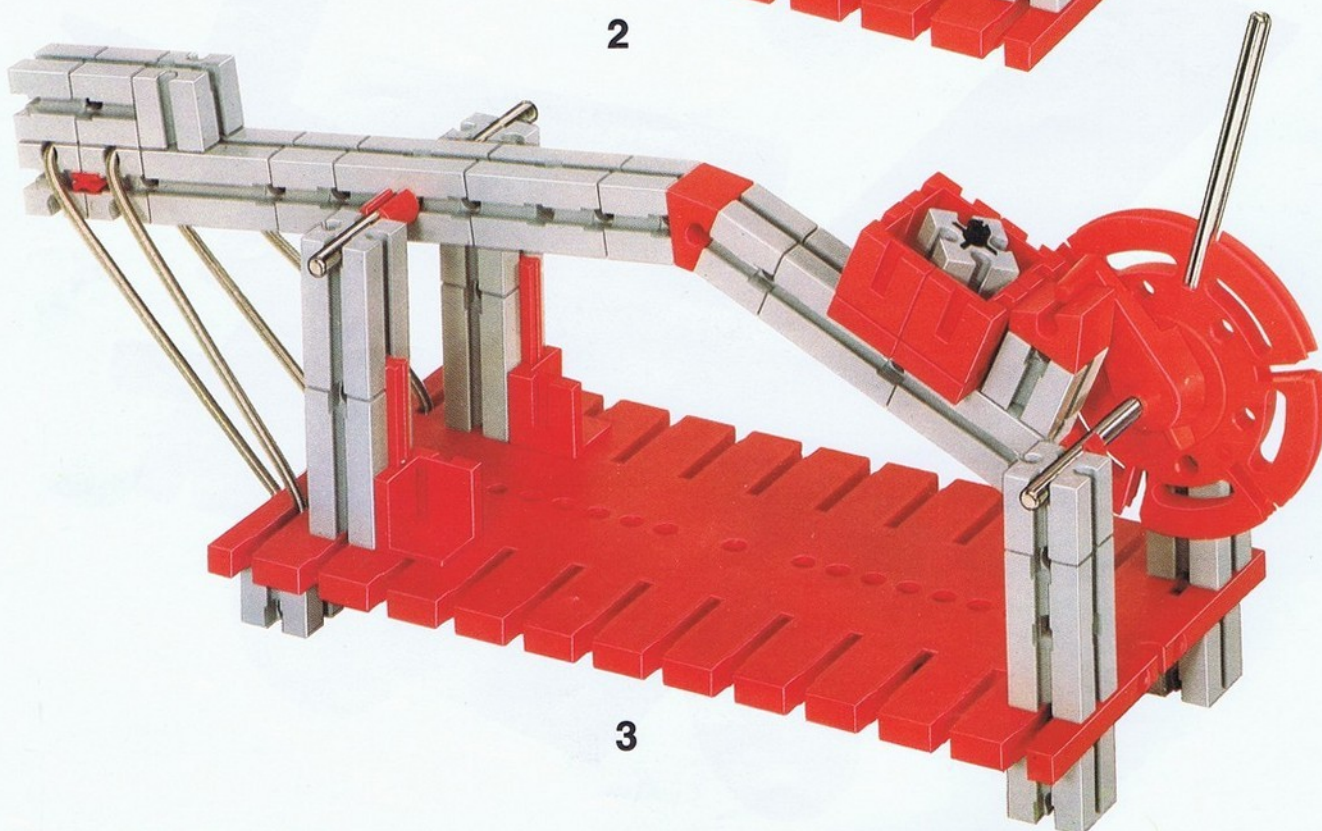

3

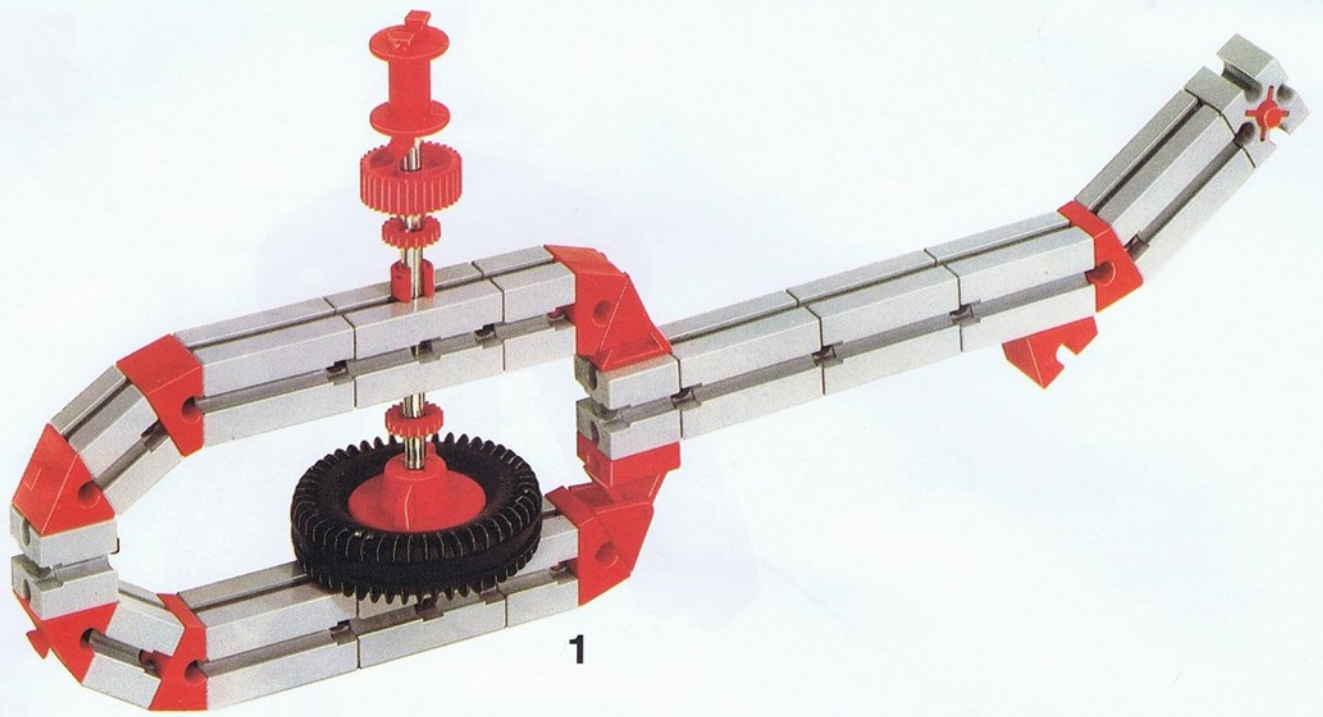

1

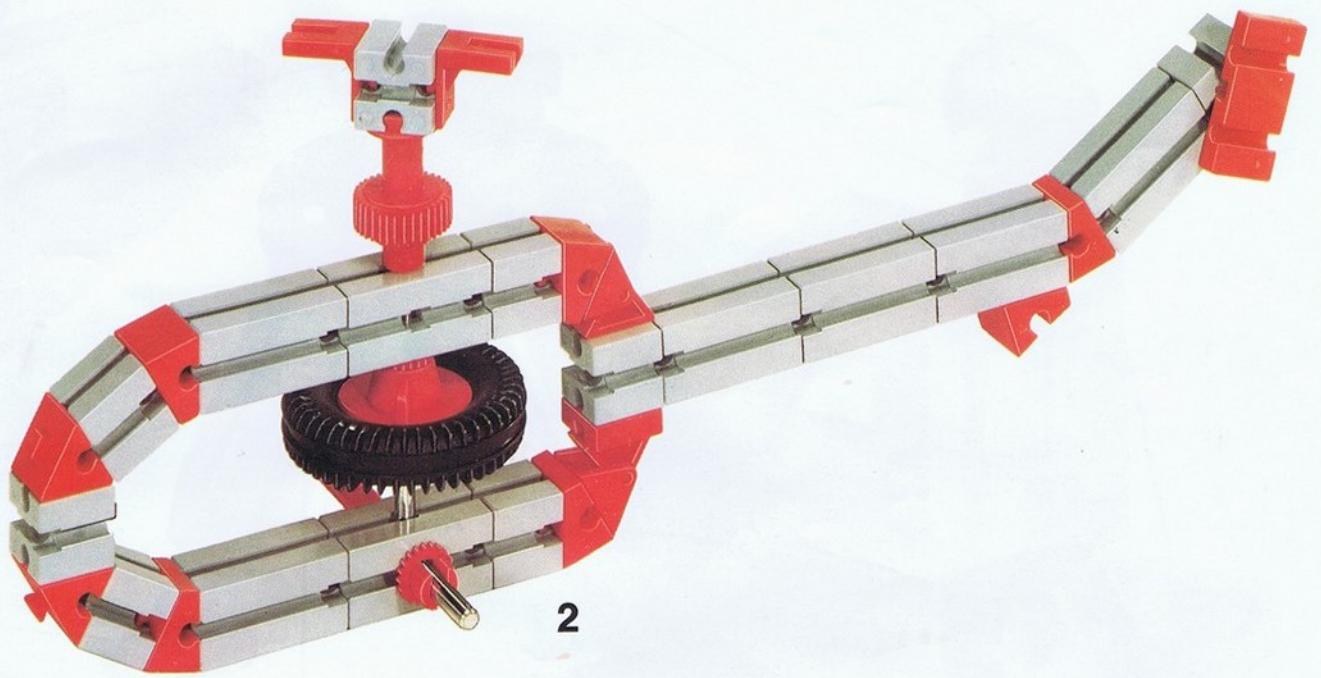

2

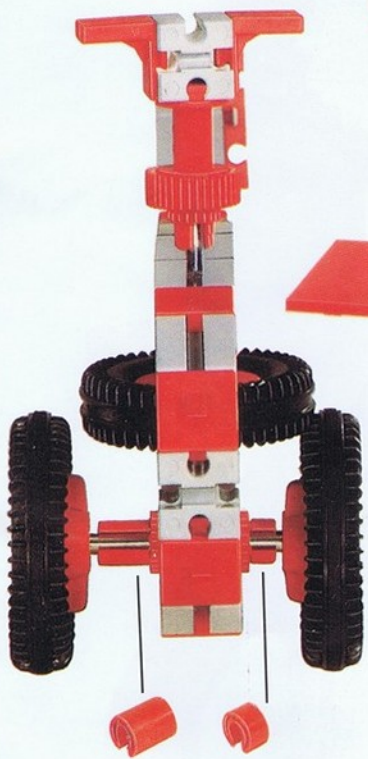

von vorne
front view
de devant
van voren
por delante
davanti
framifrån



3

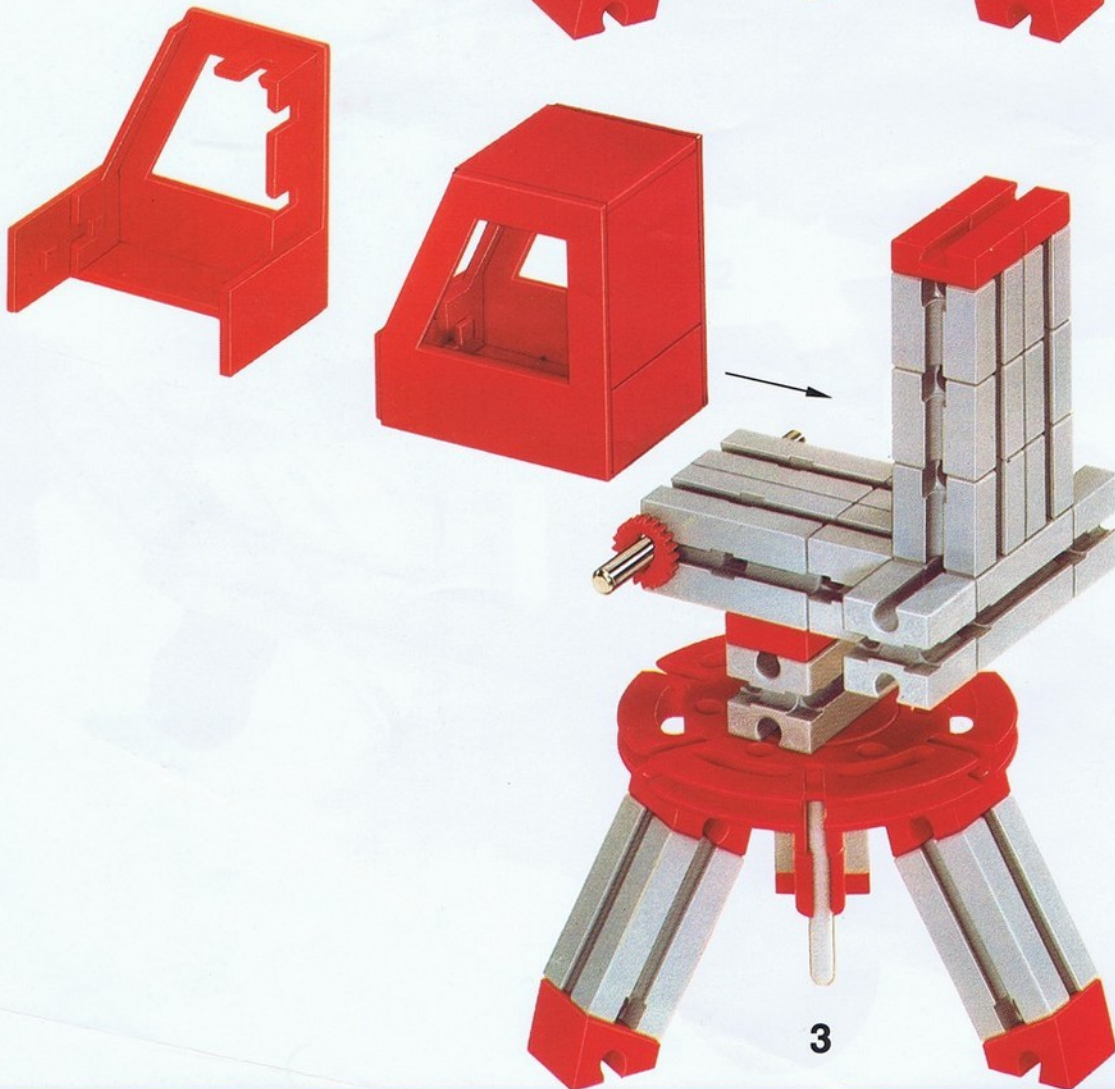
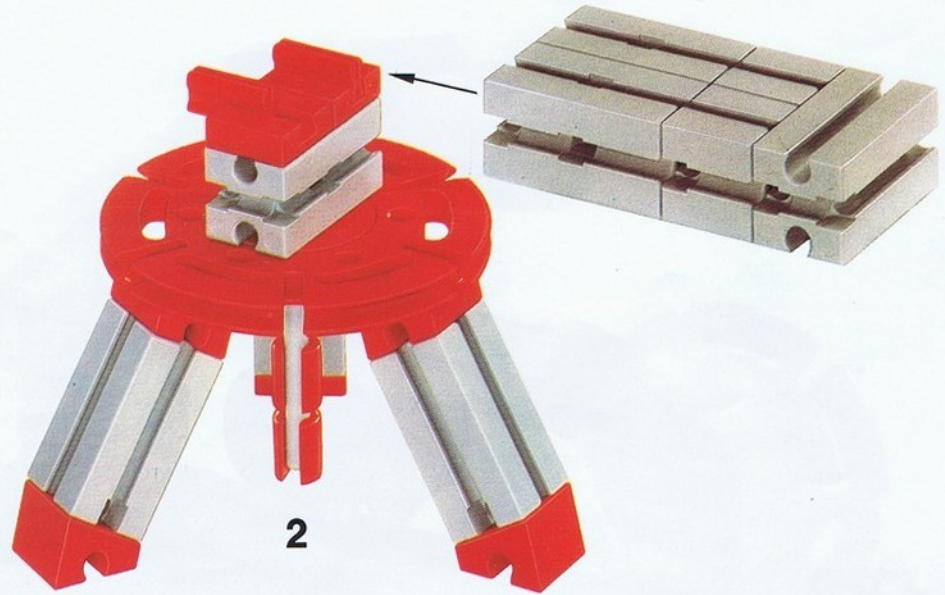
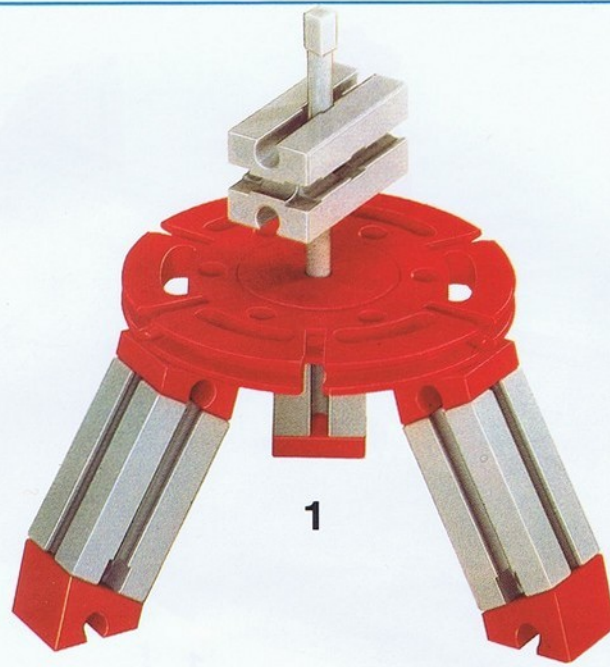



4

4

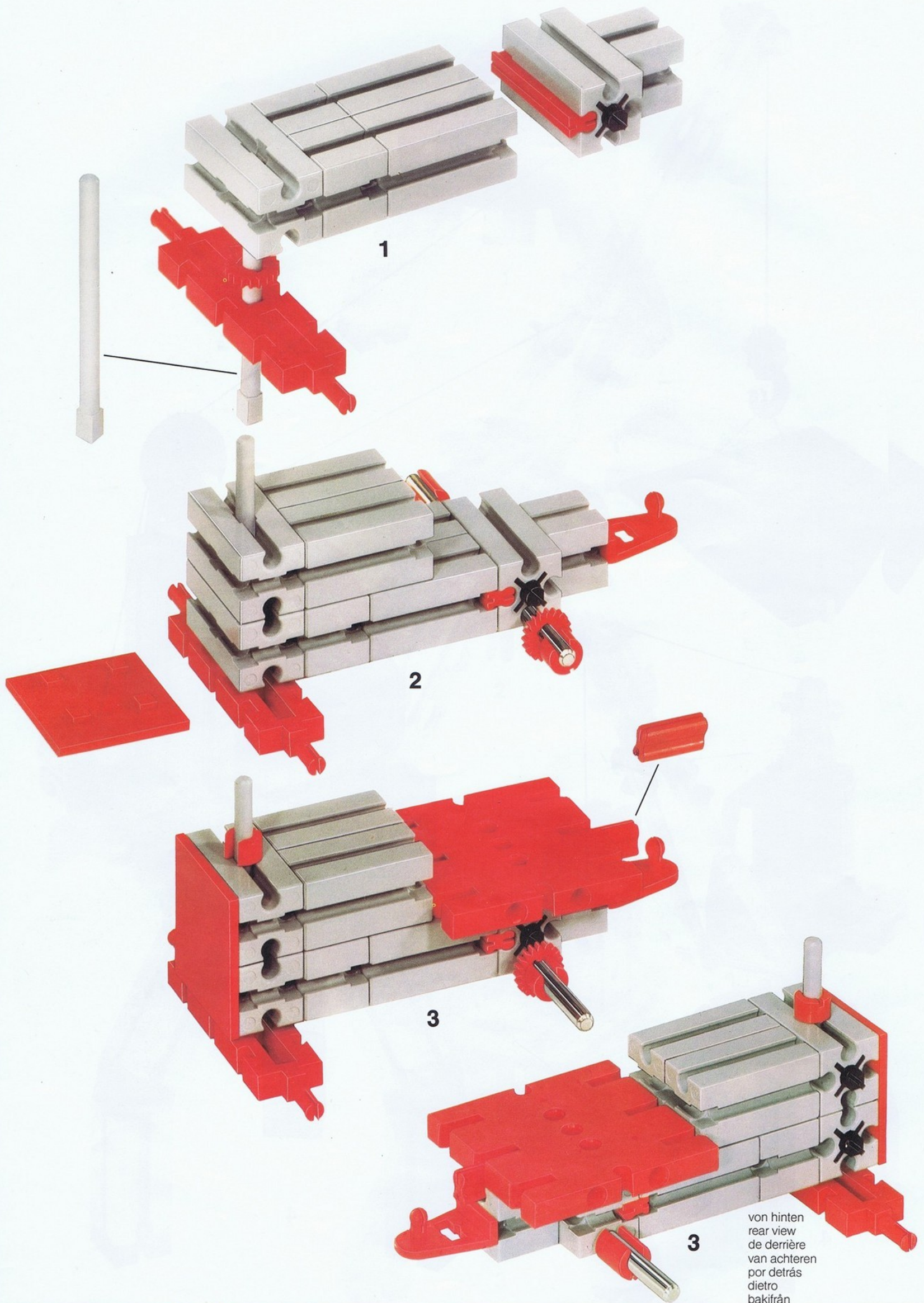

1

2

3

3

von hinten
 rear view
 de derrière
 van achteren
 por detrás
 dietro
 bakifrån



4

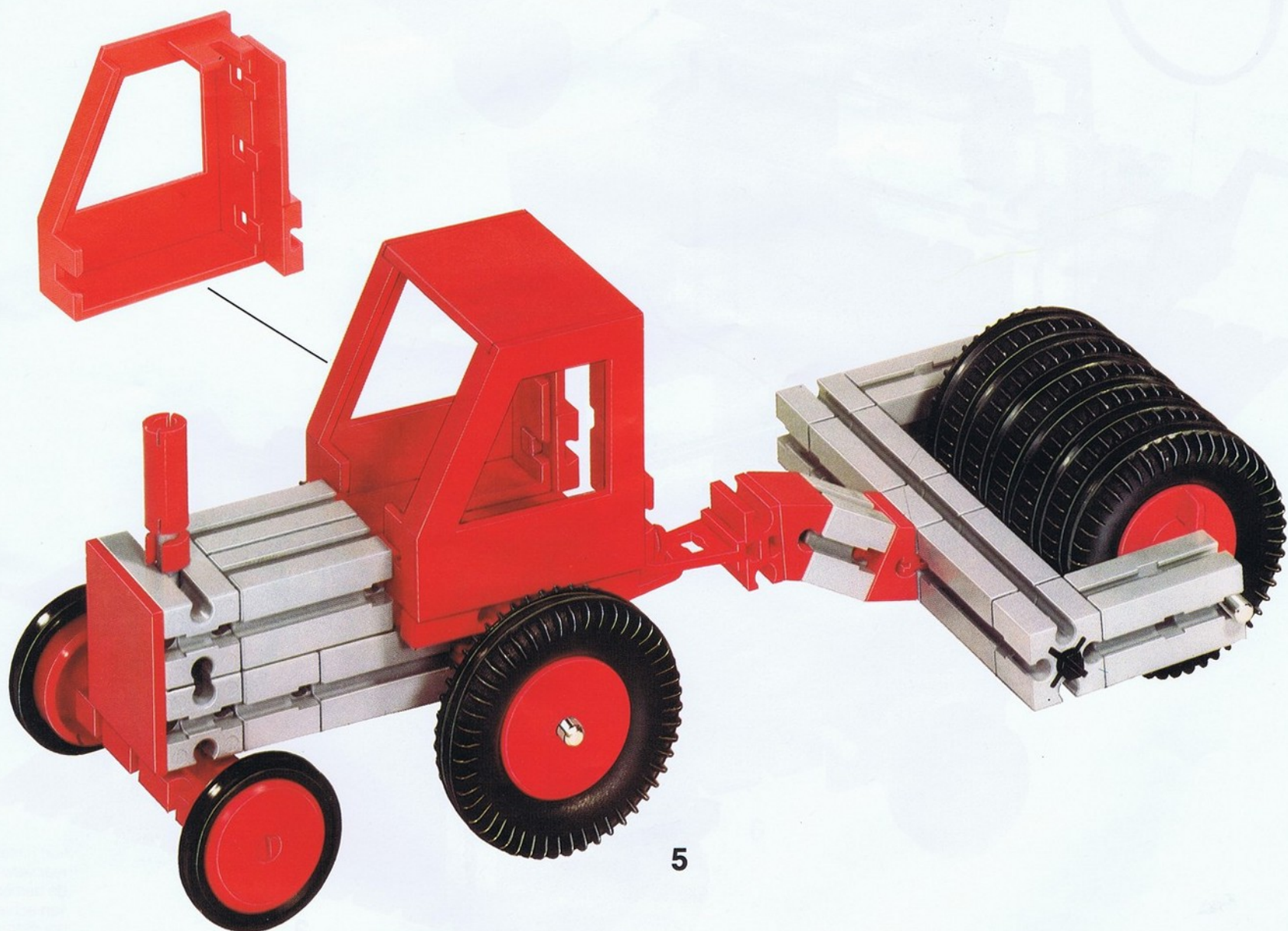

5

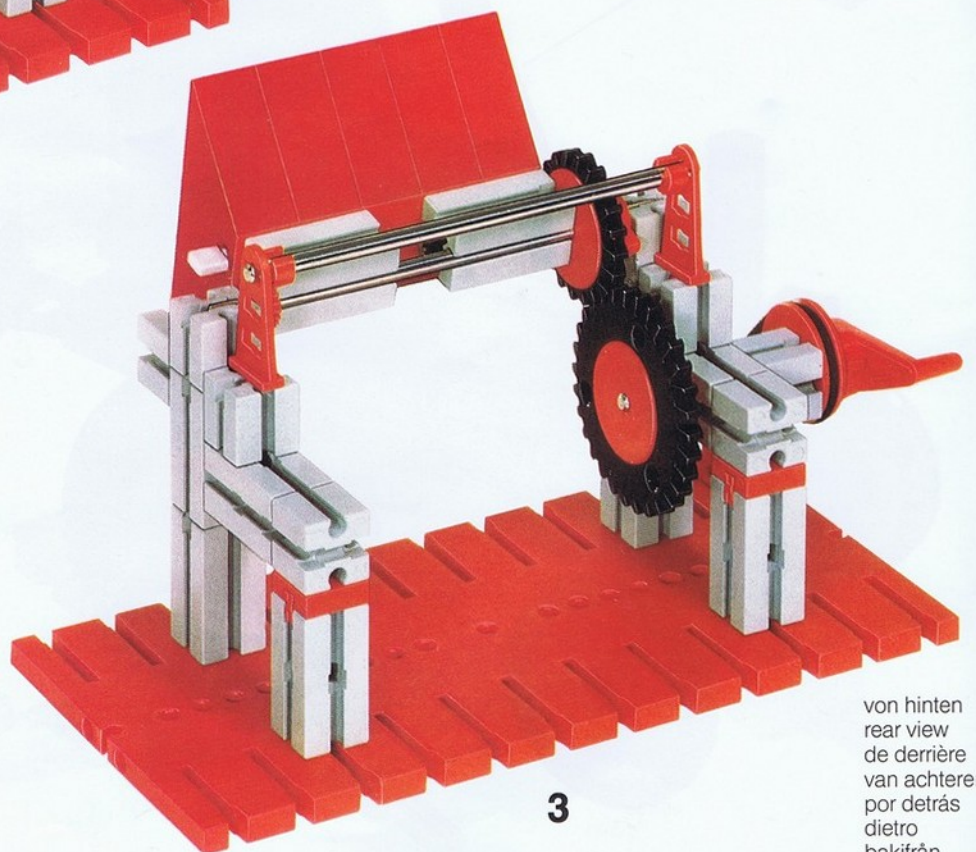
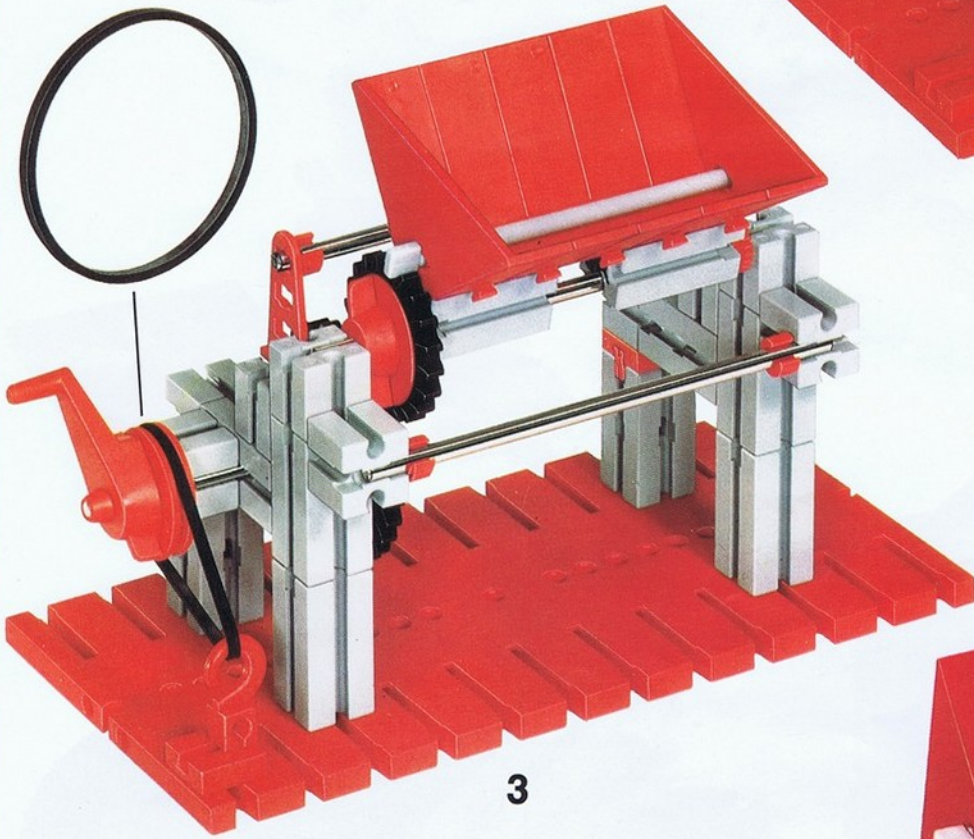
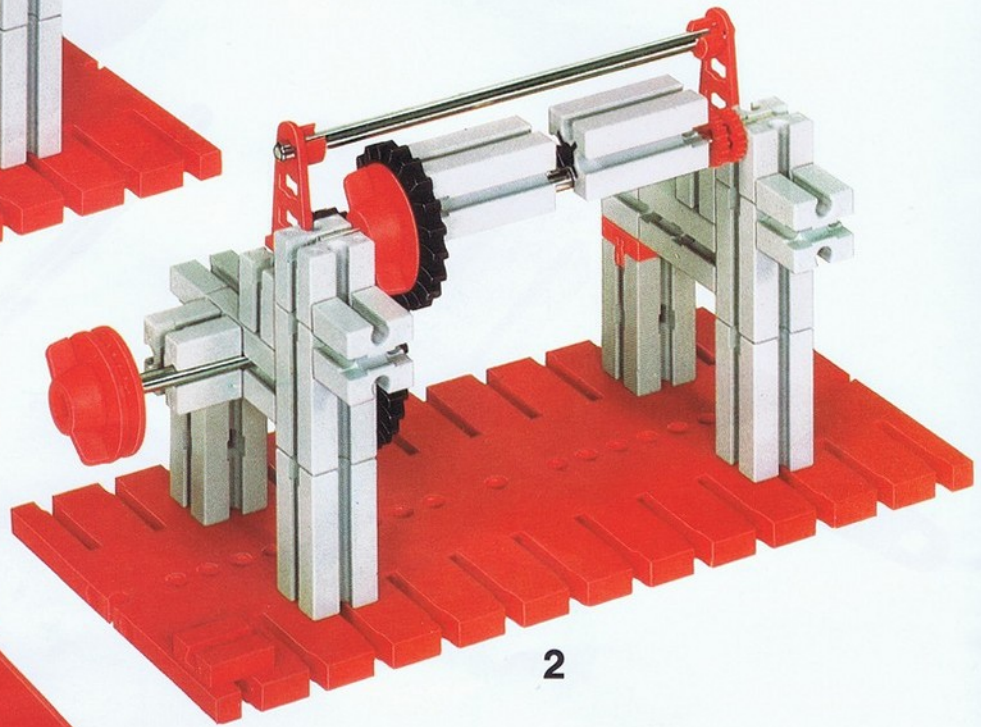
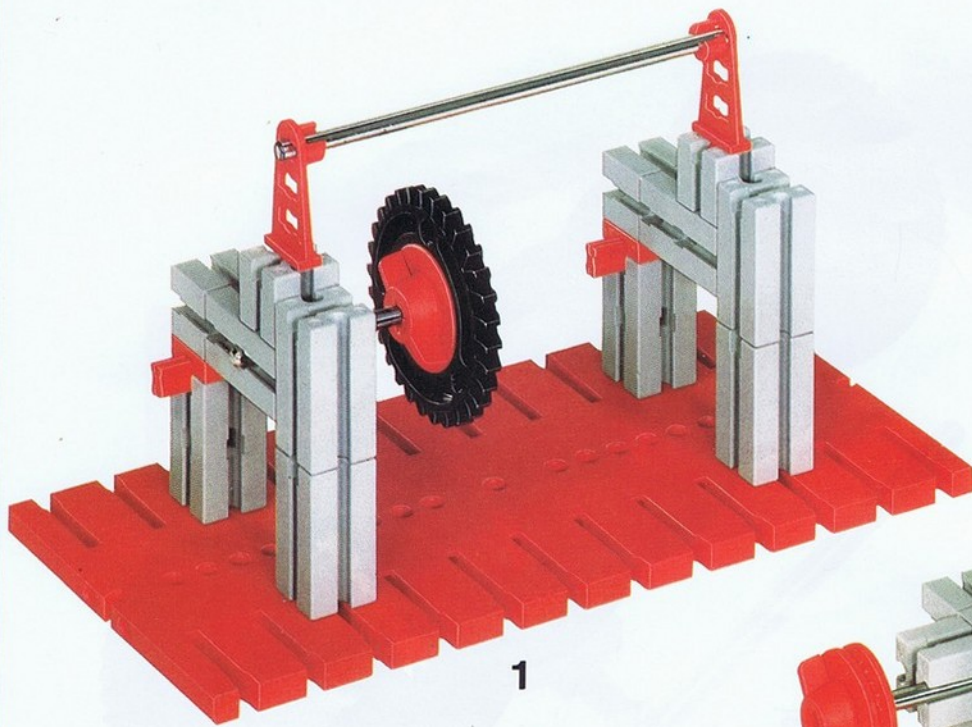

von hinten
rear view
de derrière
van achteren
por detrás
dietro
bakifrån

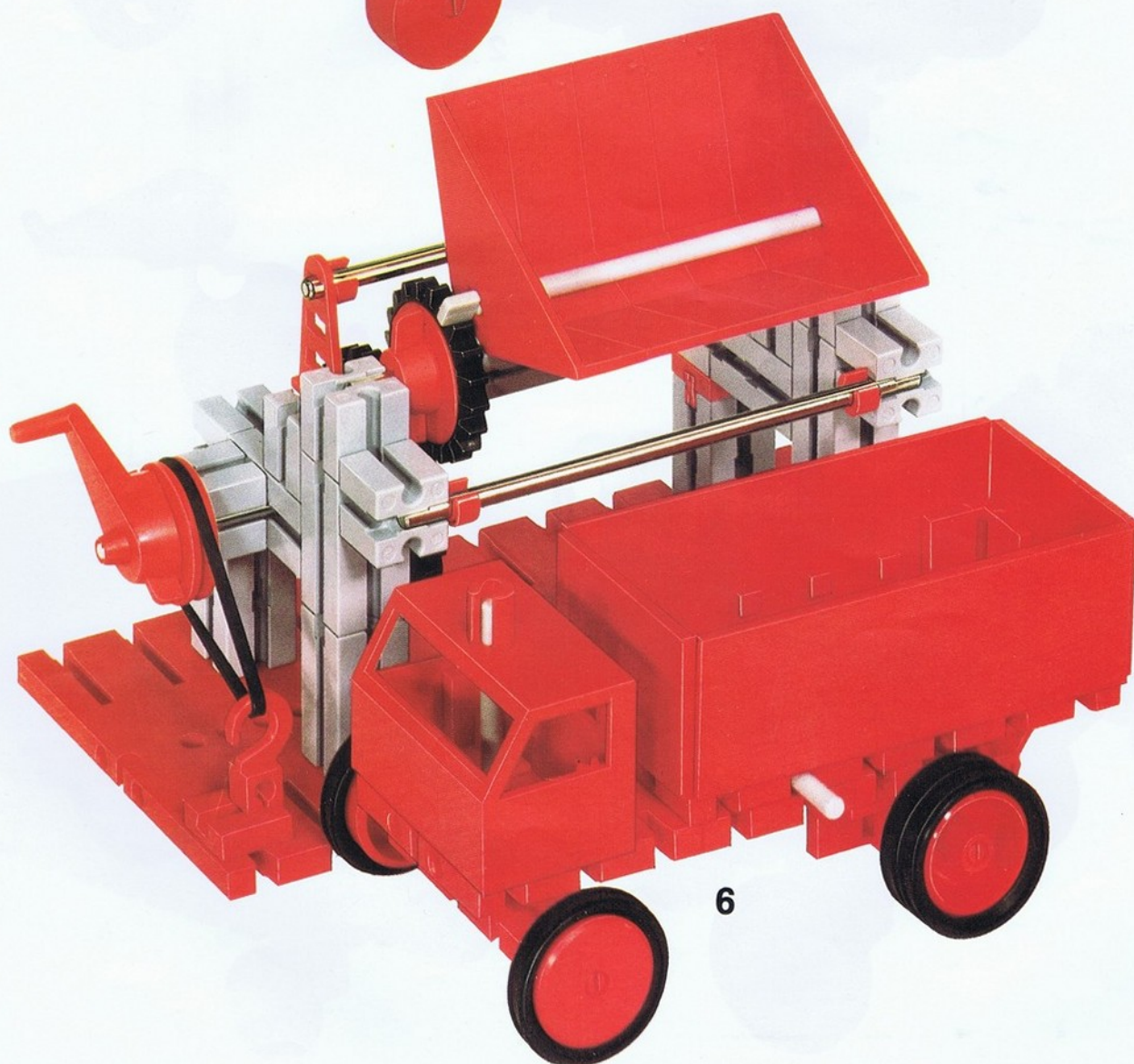
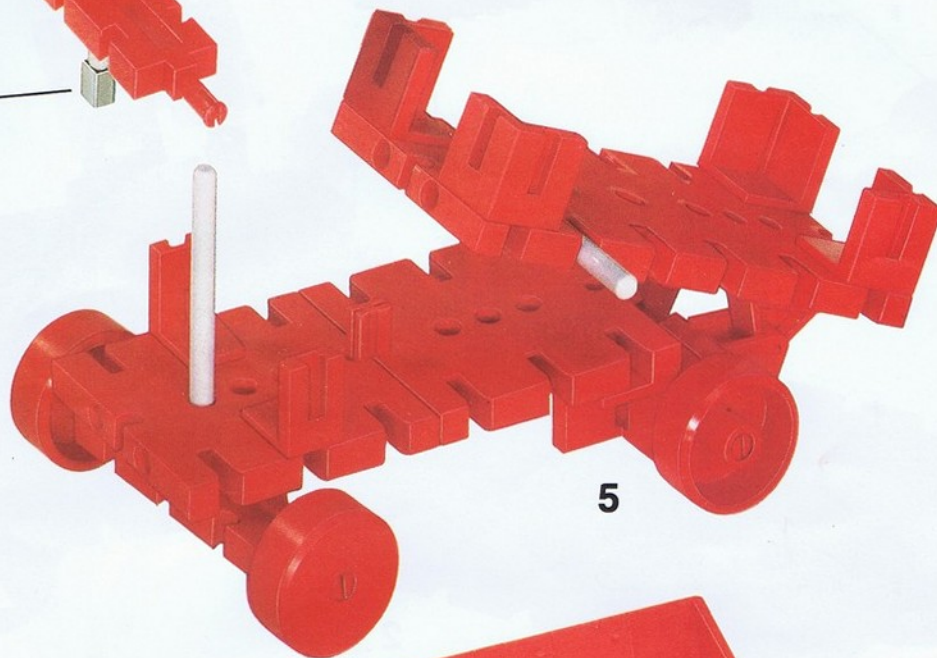
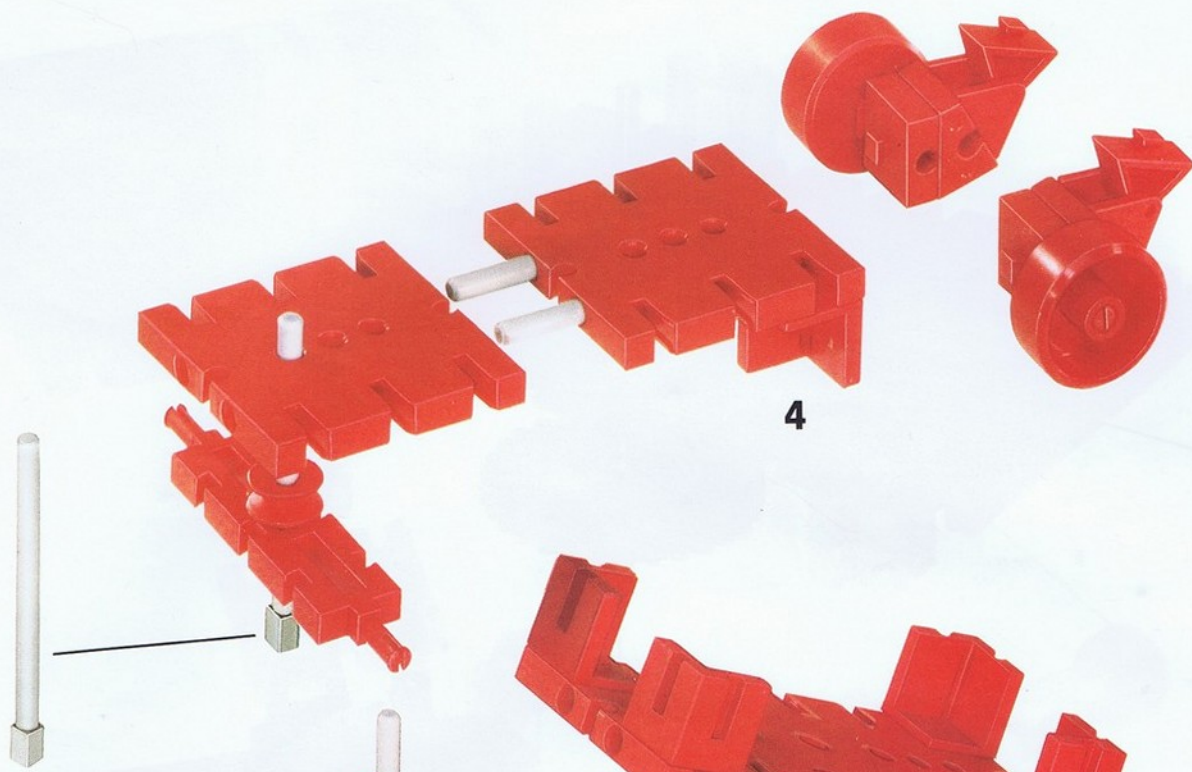

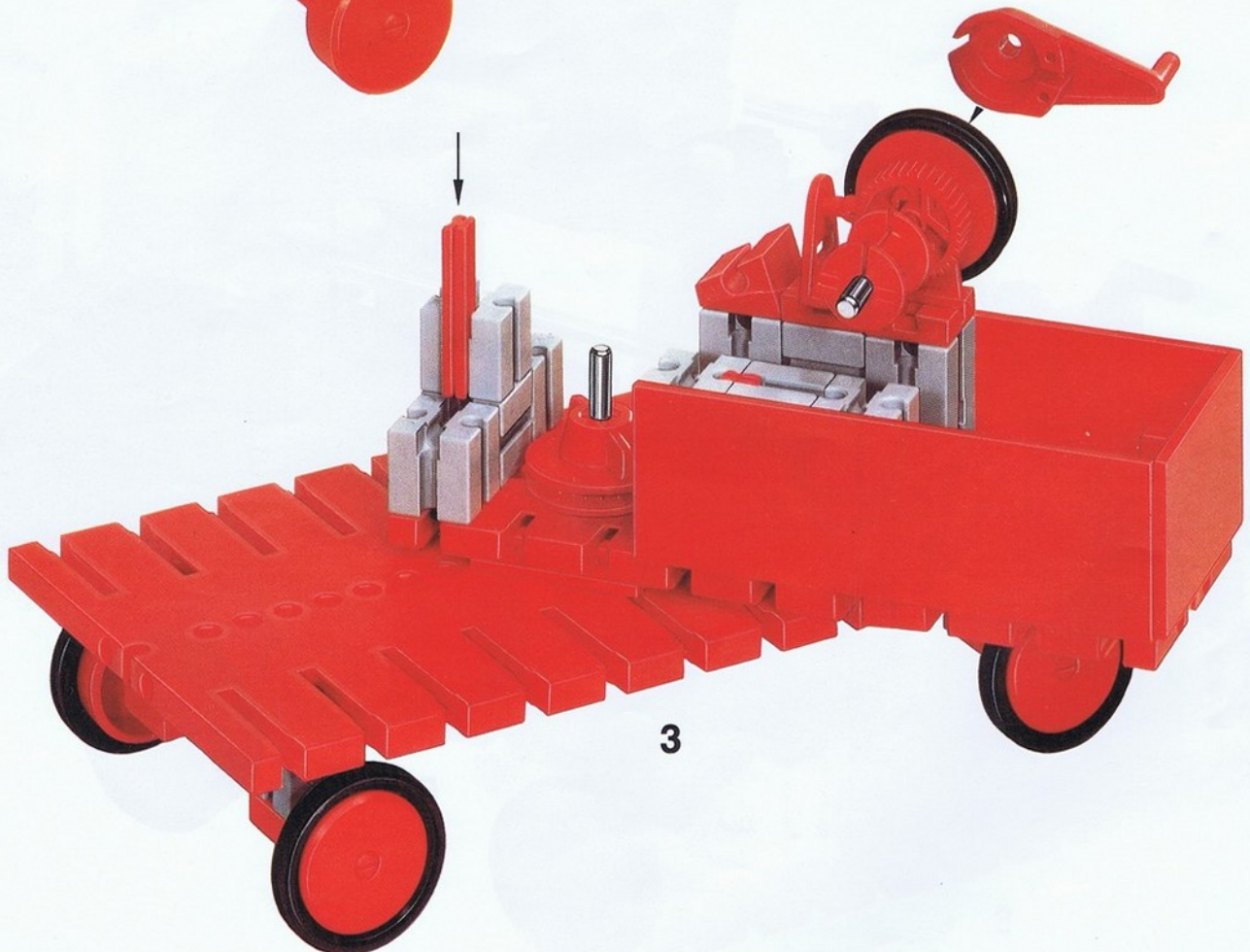
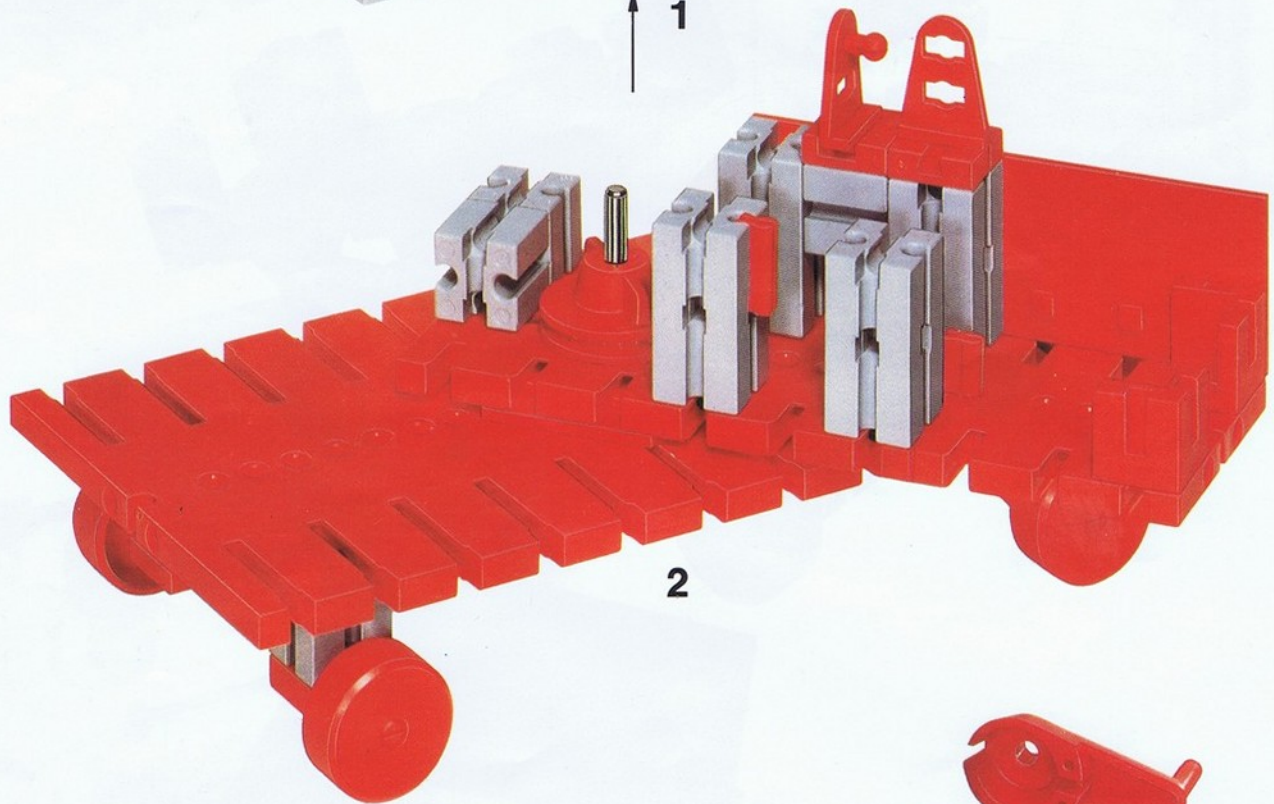
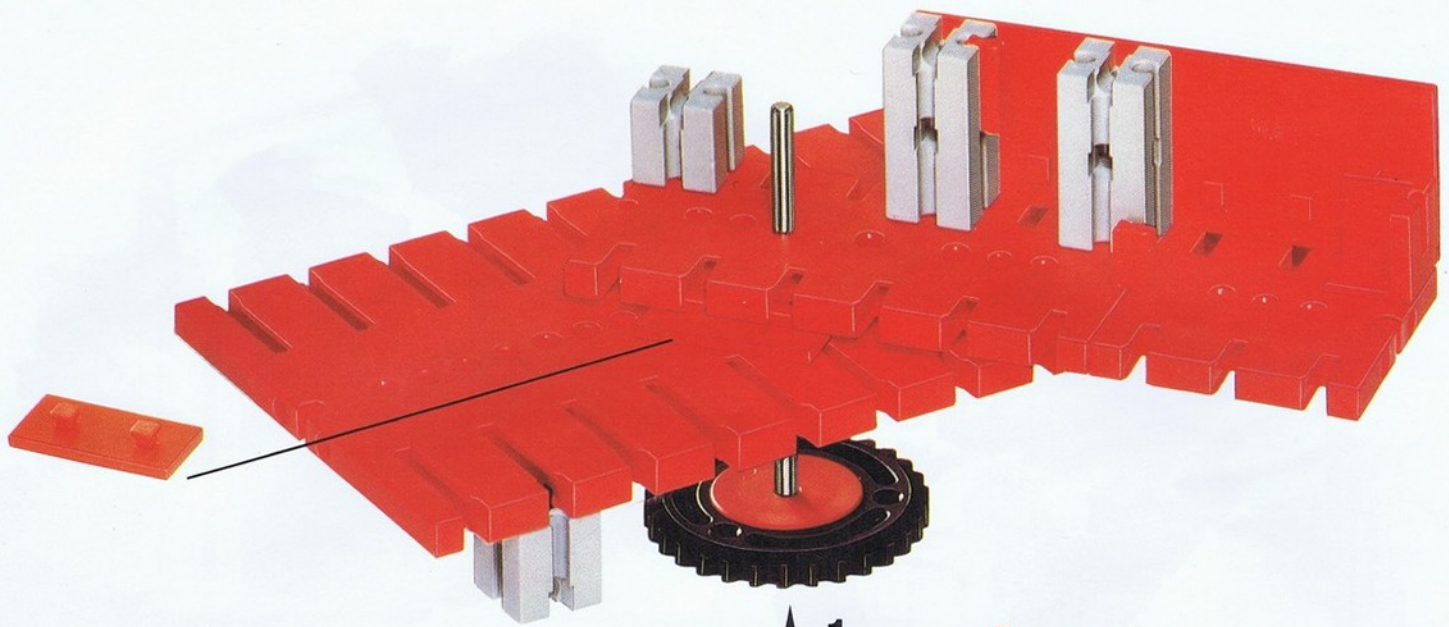



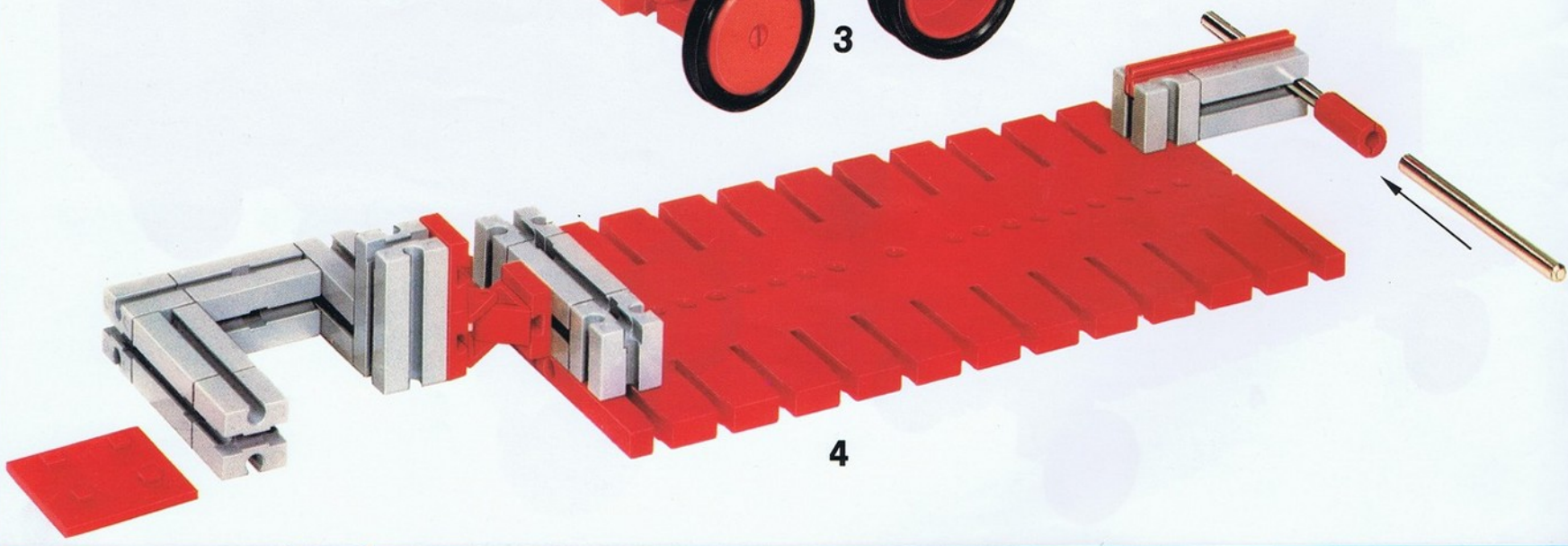
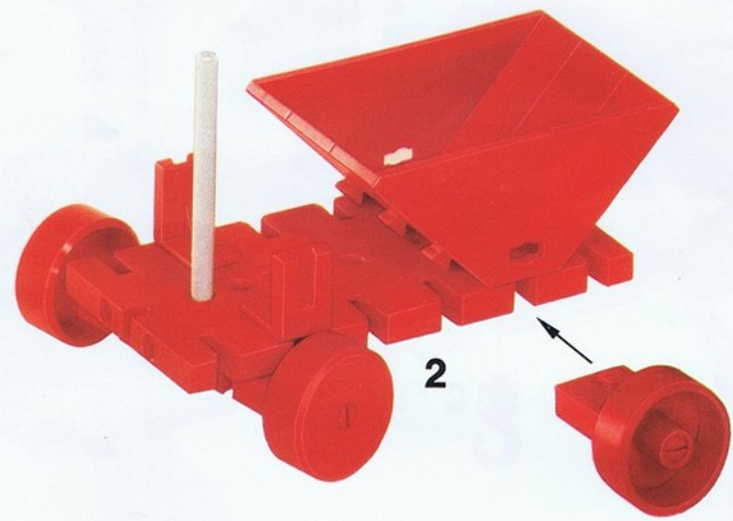
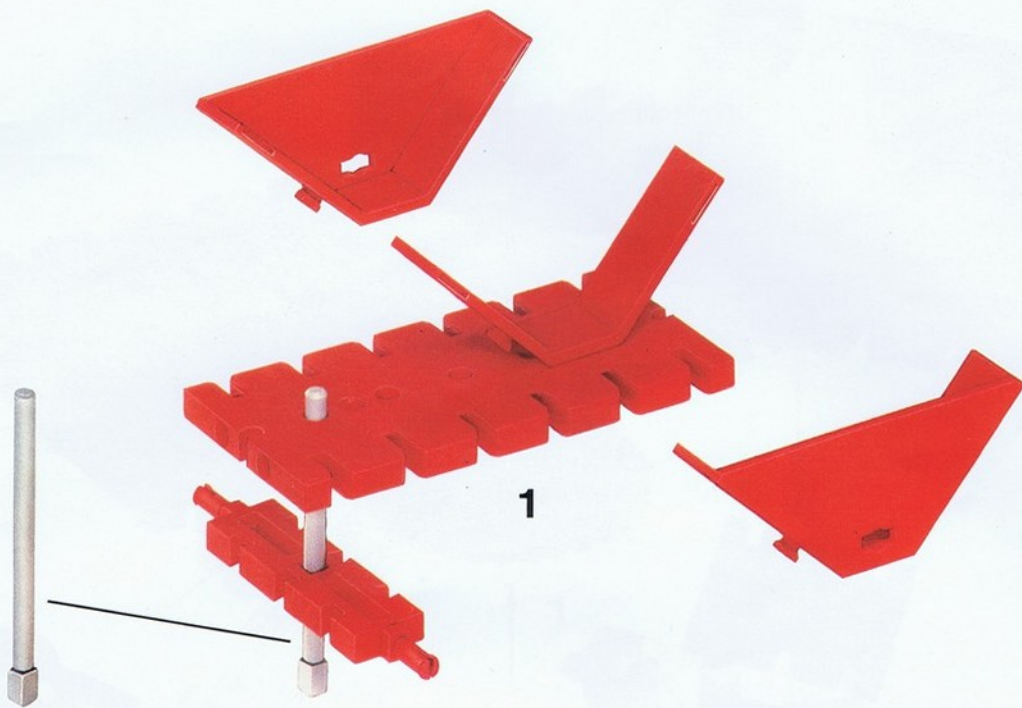

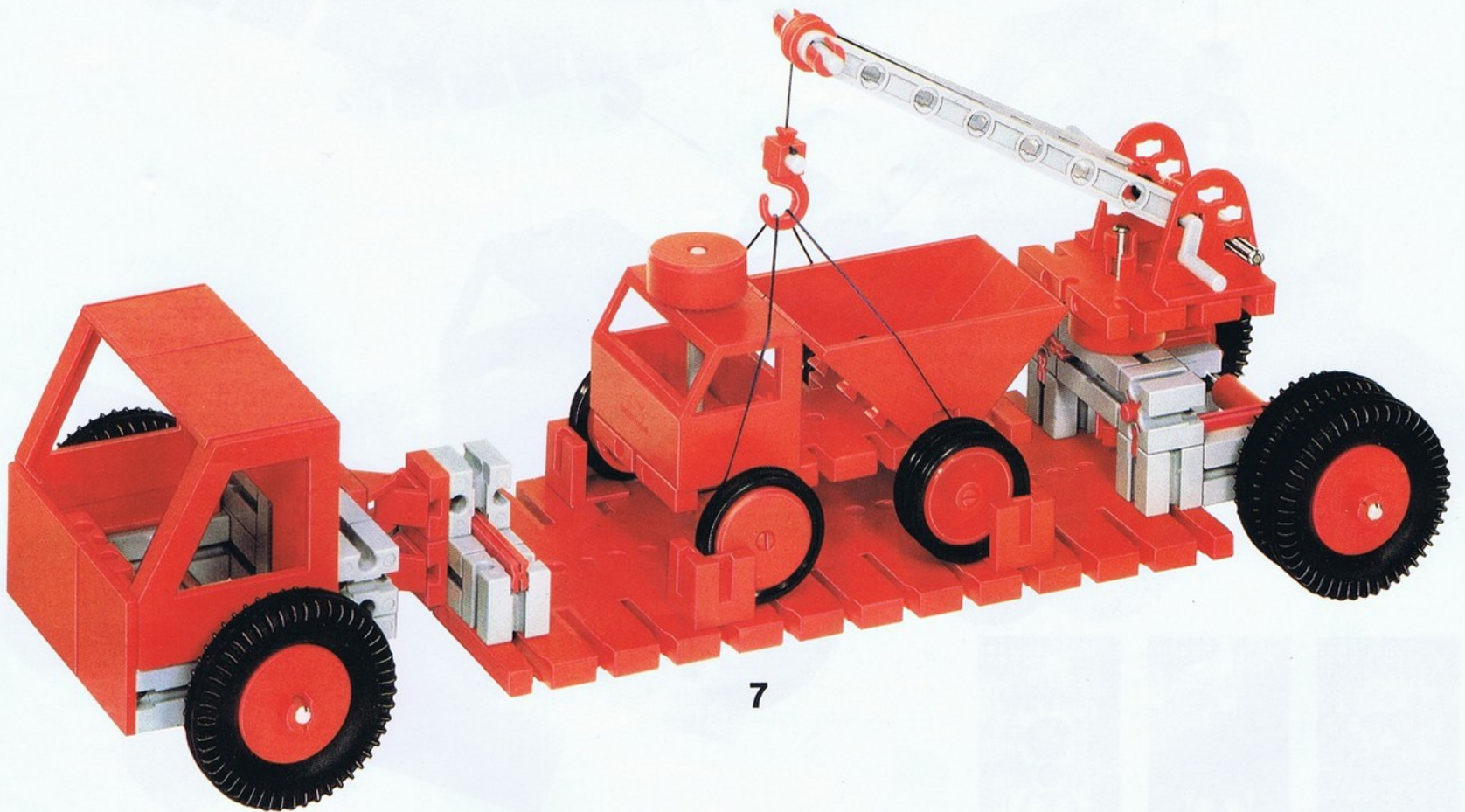
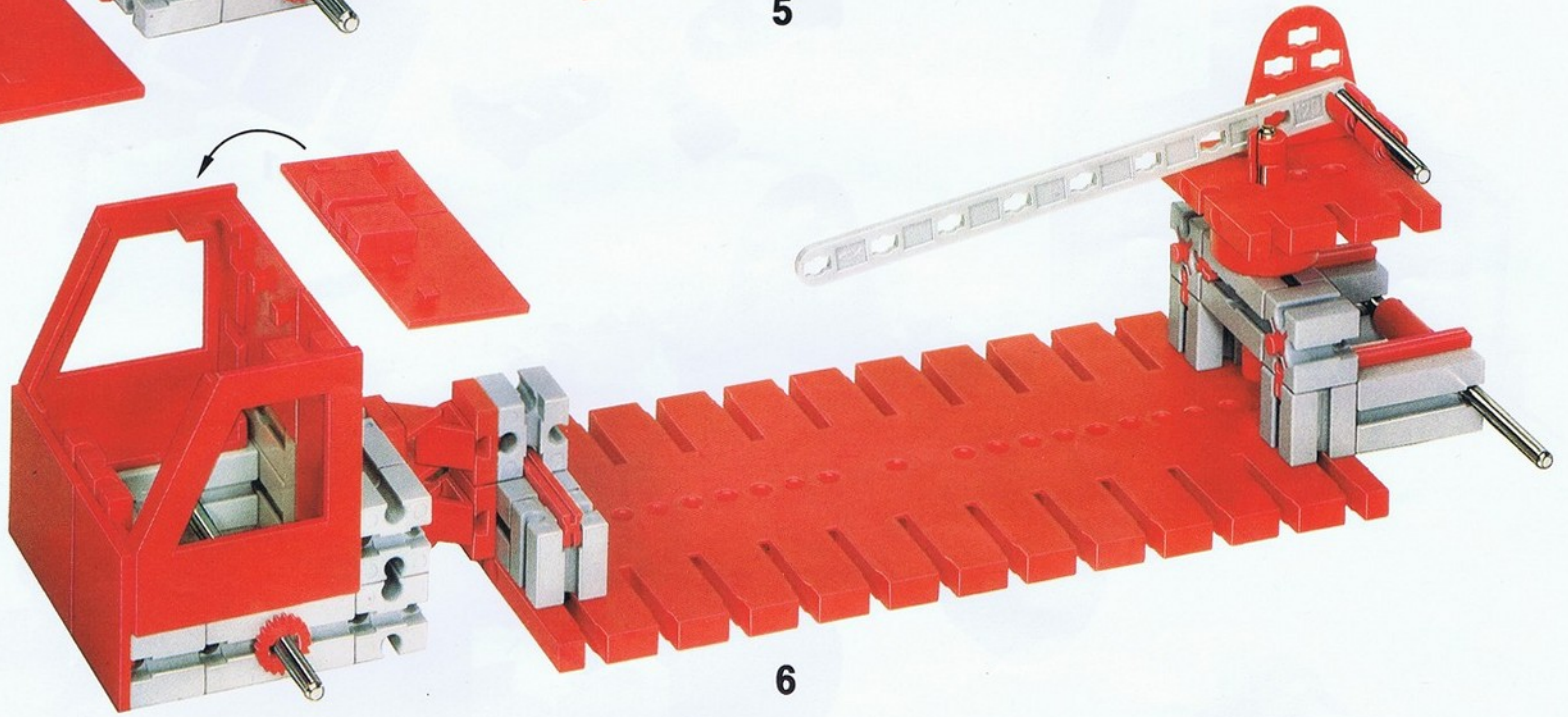
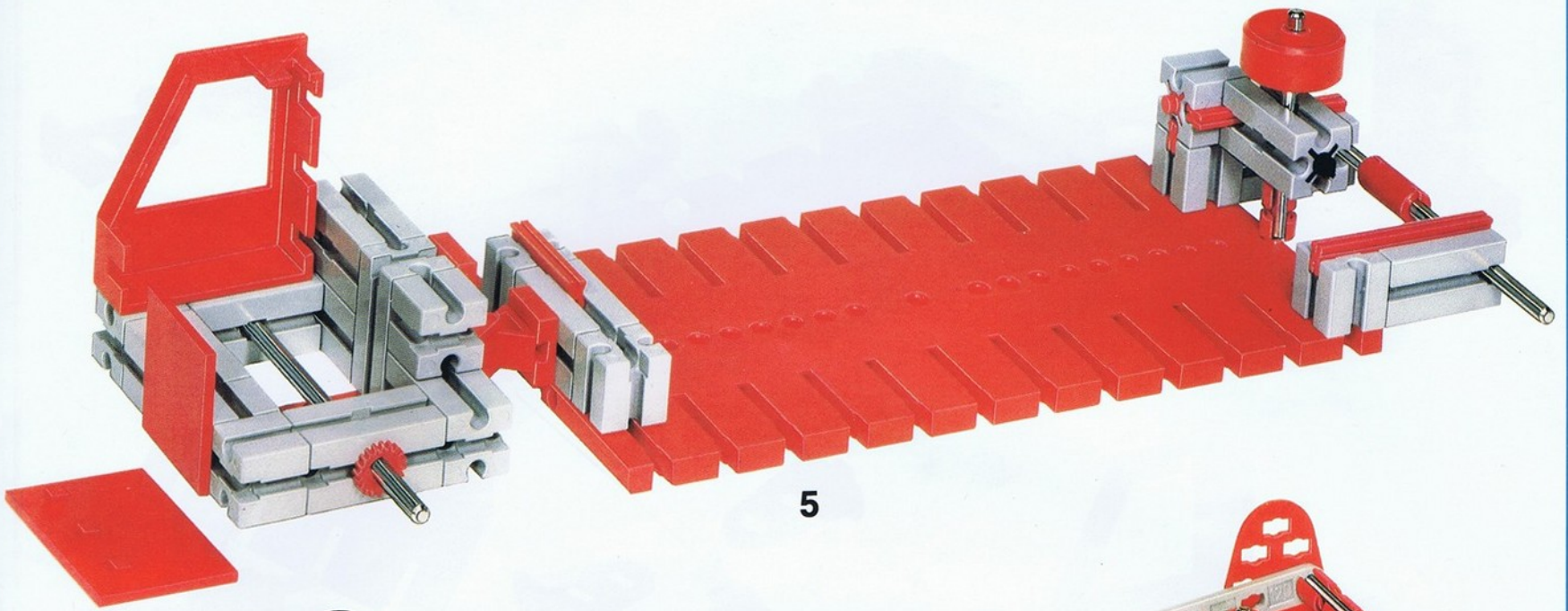

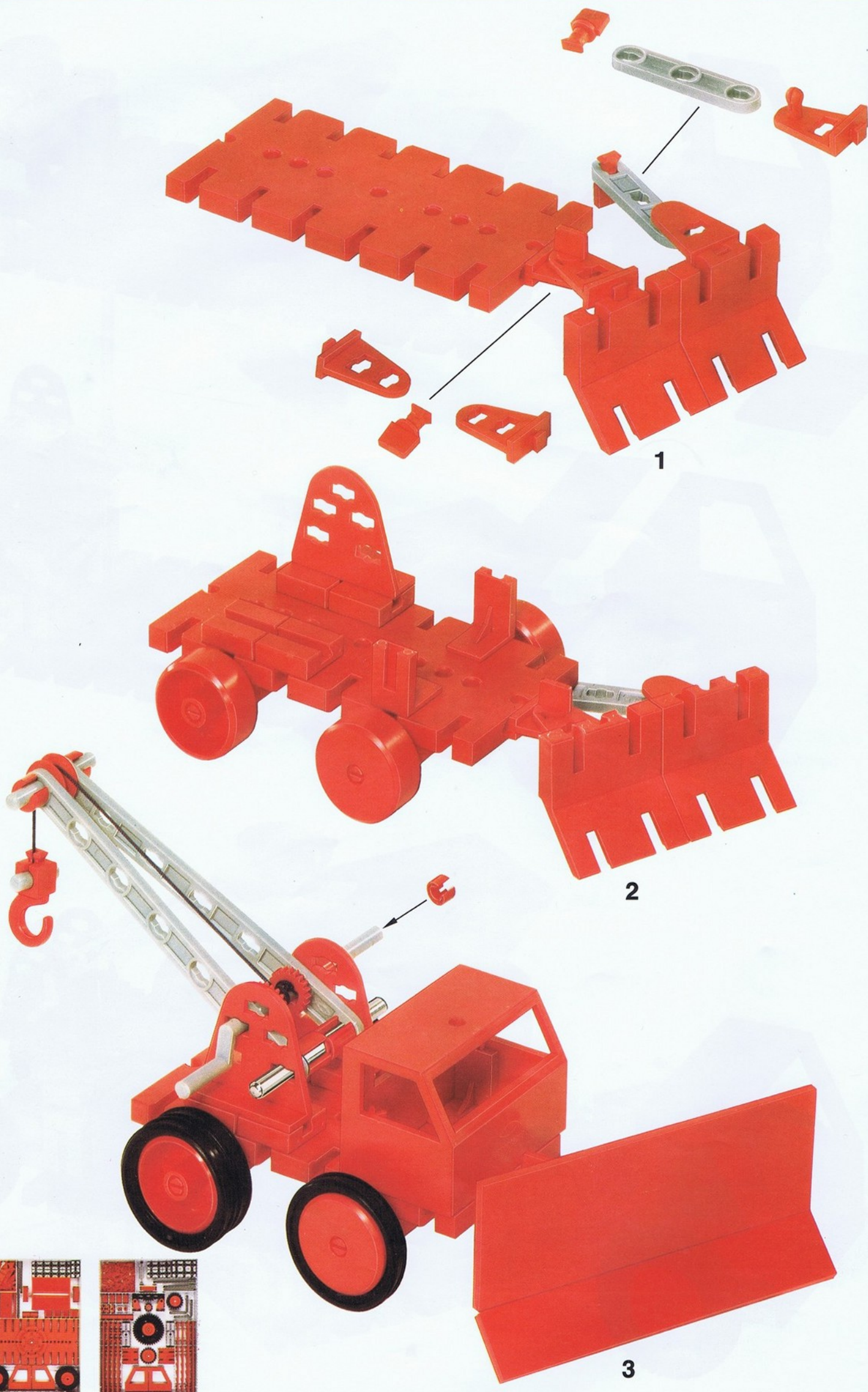

1

2

3

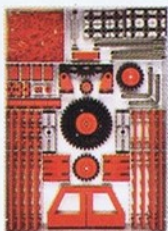
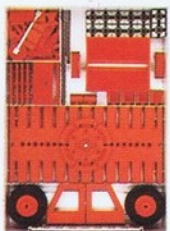



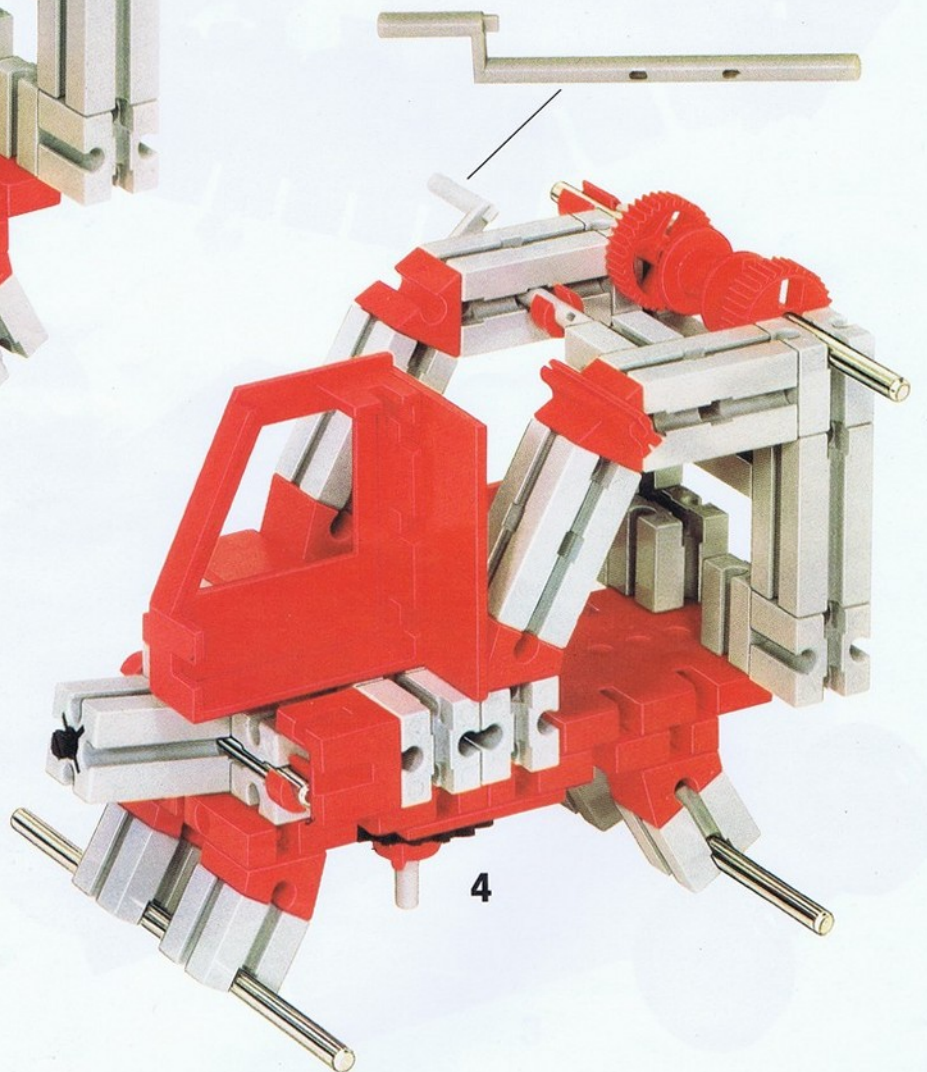
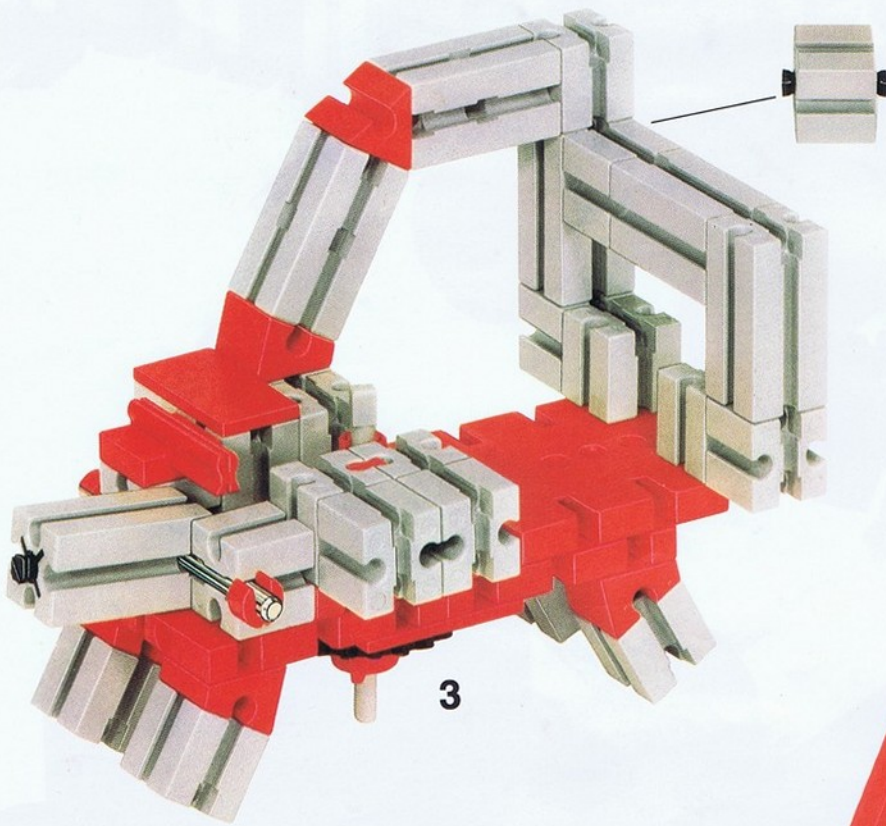
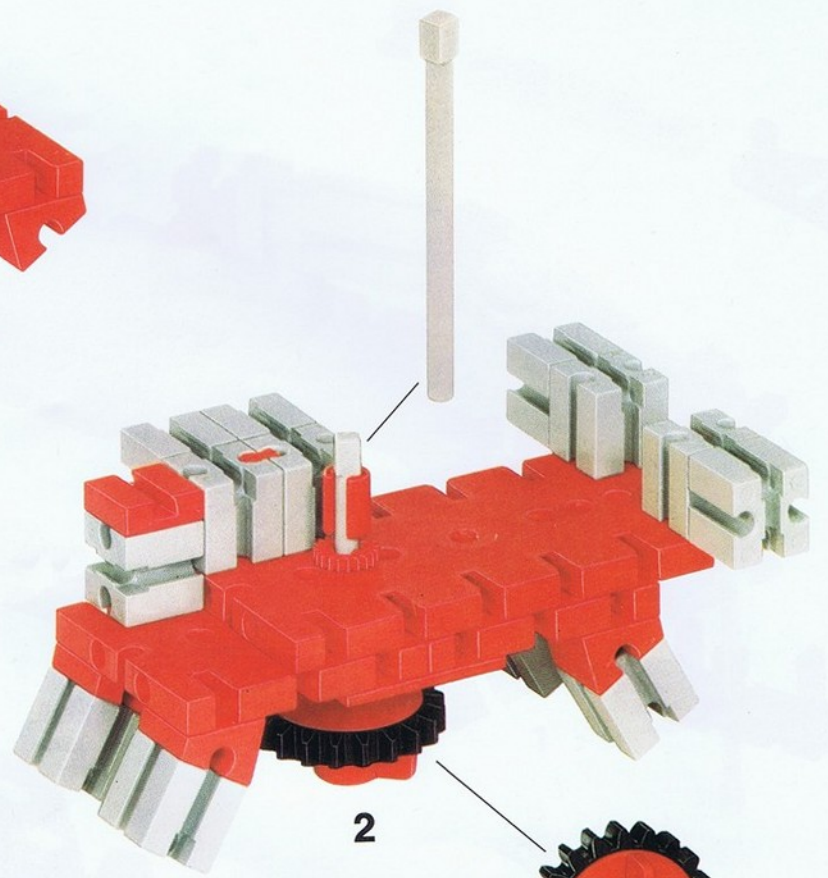
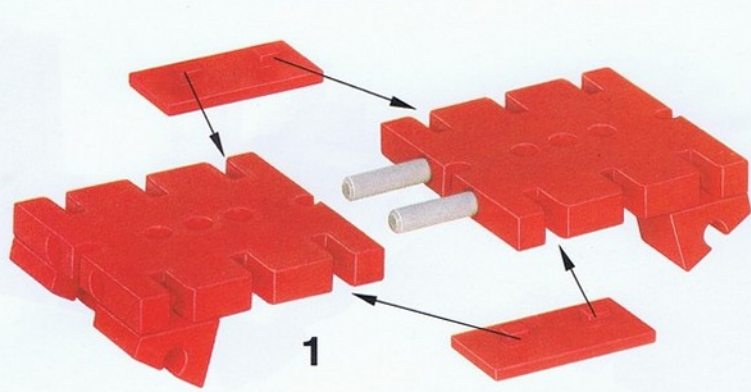



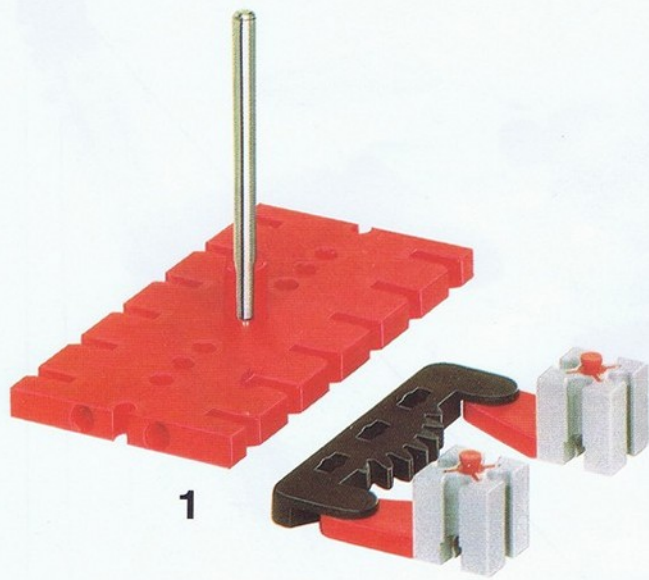

1

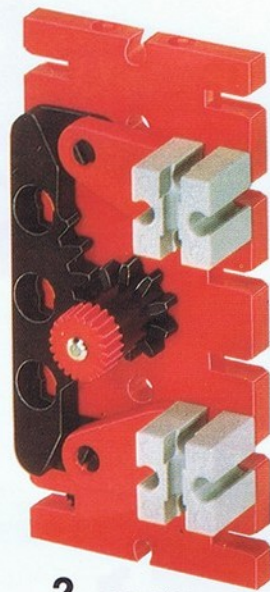

2

von unten
underside
d'en bas
van onderen
de abajo
sotto
underifrån

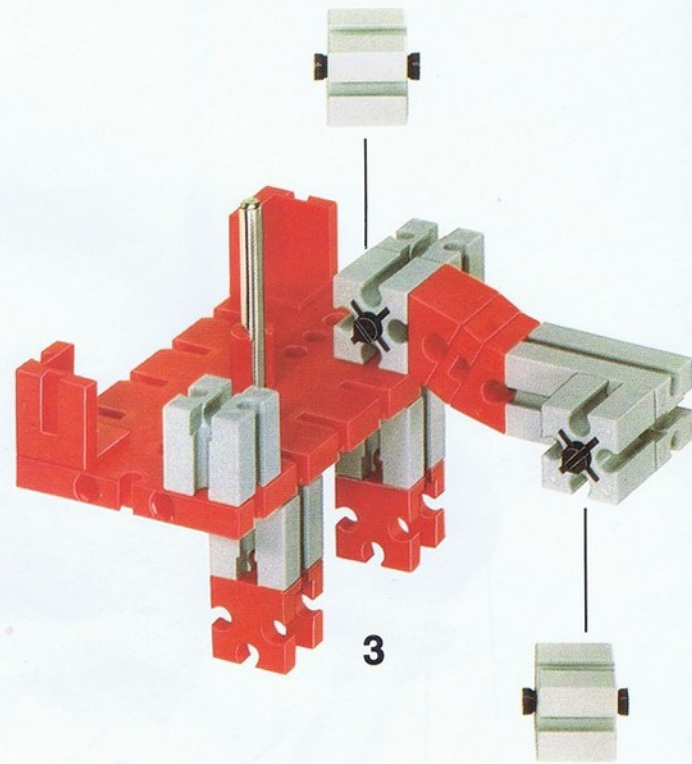

3

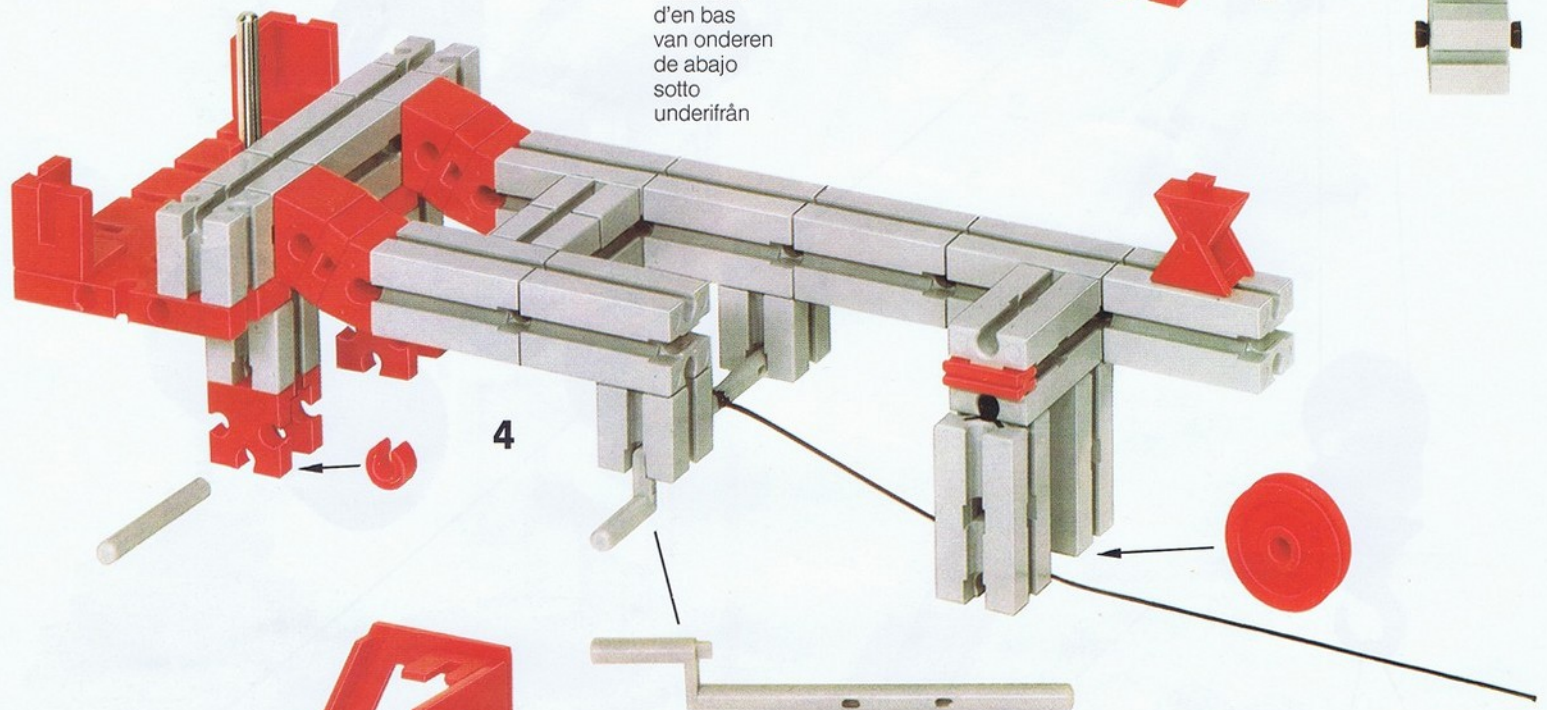

4

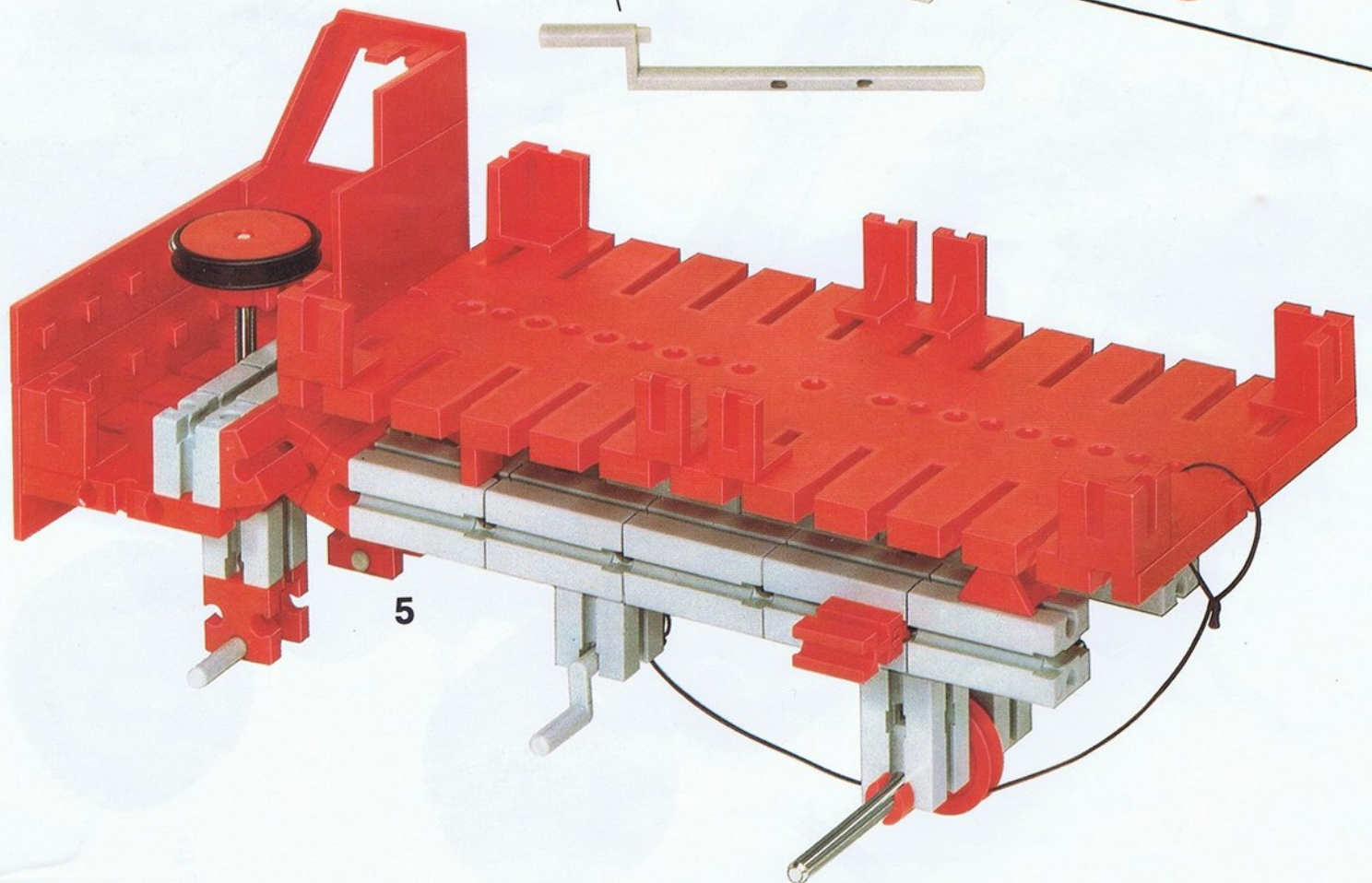

5



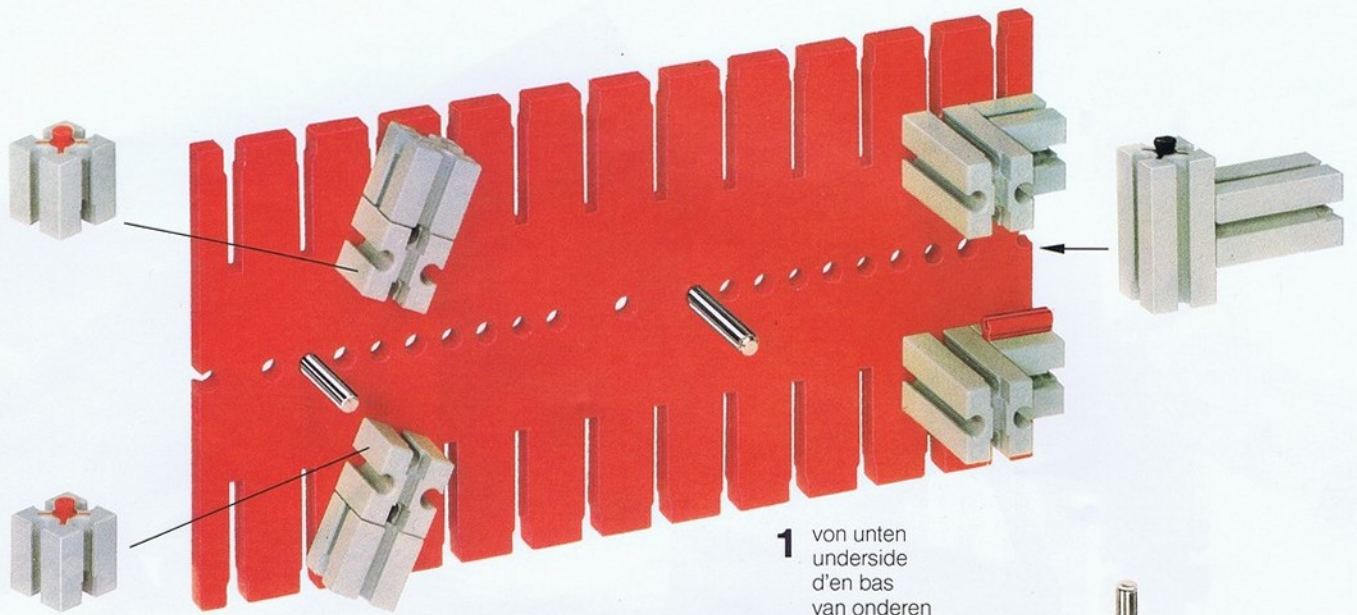

1 von unten
underside
d'en bas
van onderen
de abajo
sotto
underifrån

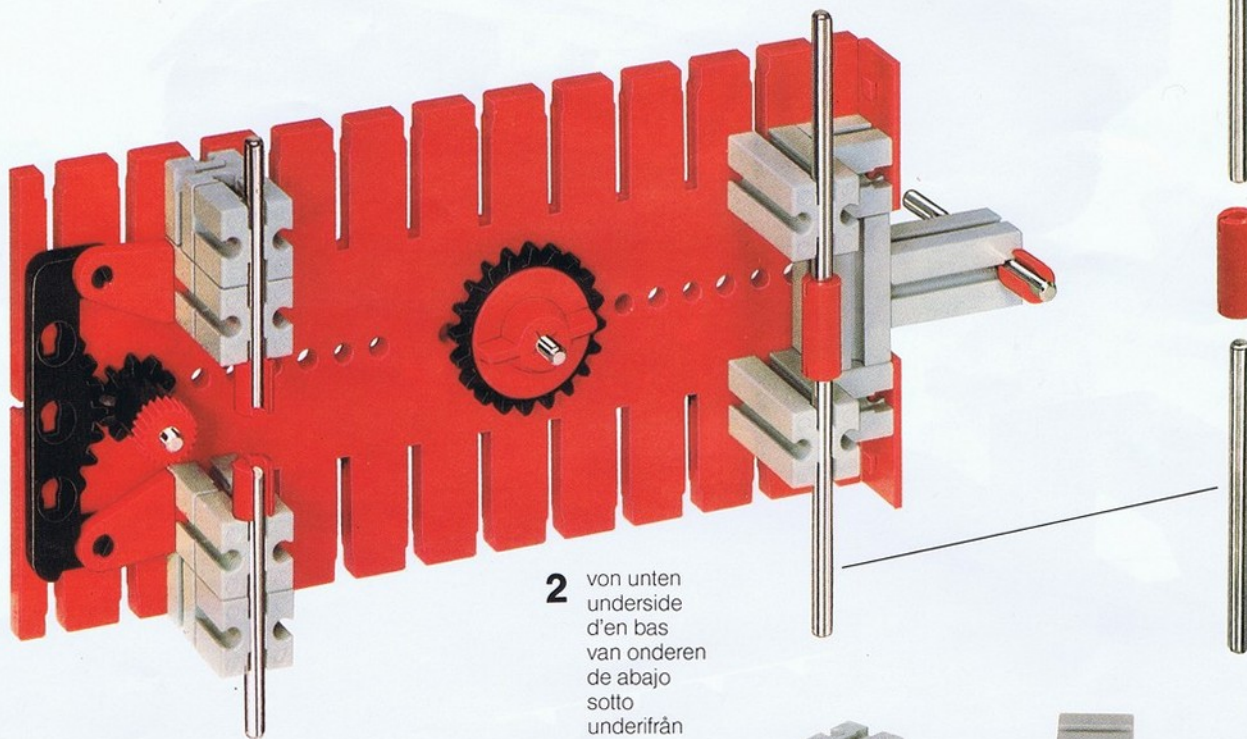

2 von unten
underside
d'en bas
van onderen
de abajo
sotto
underifrån

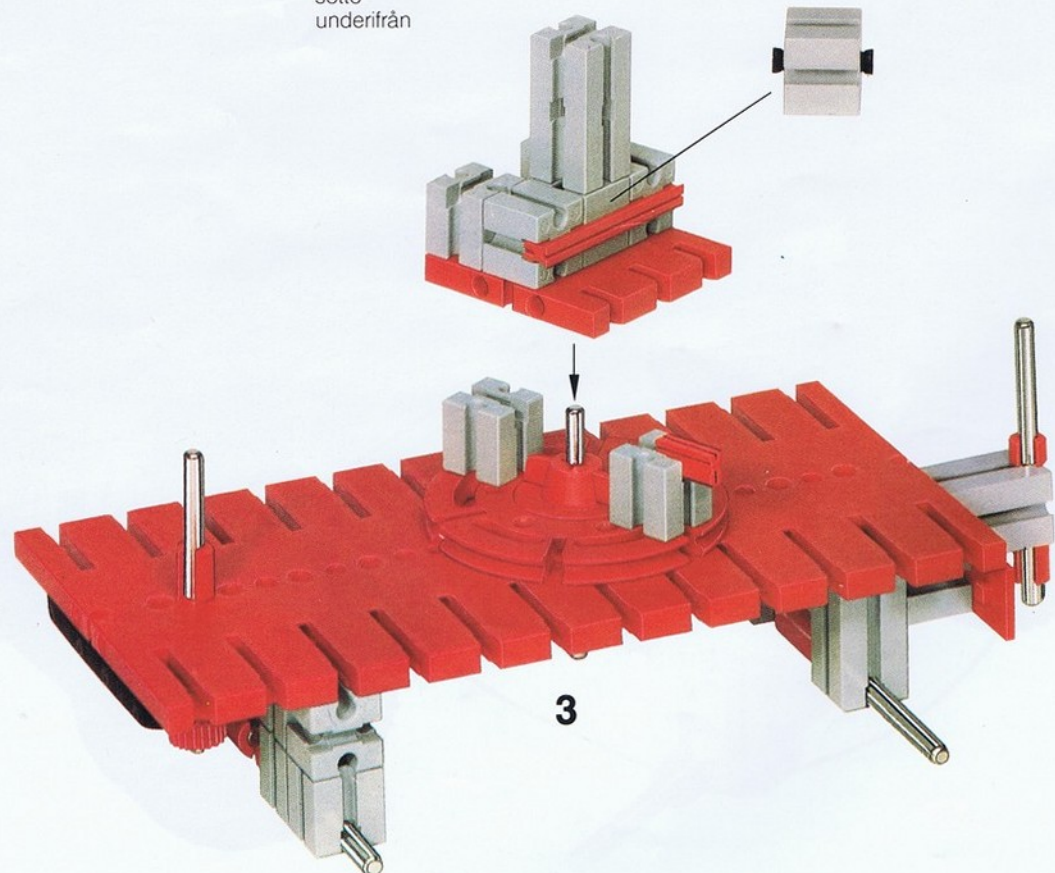

3

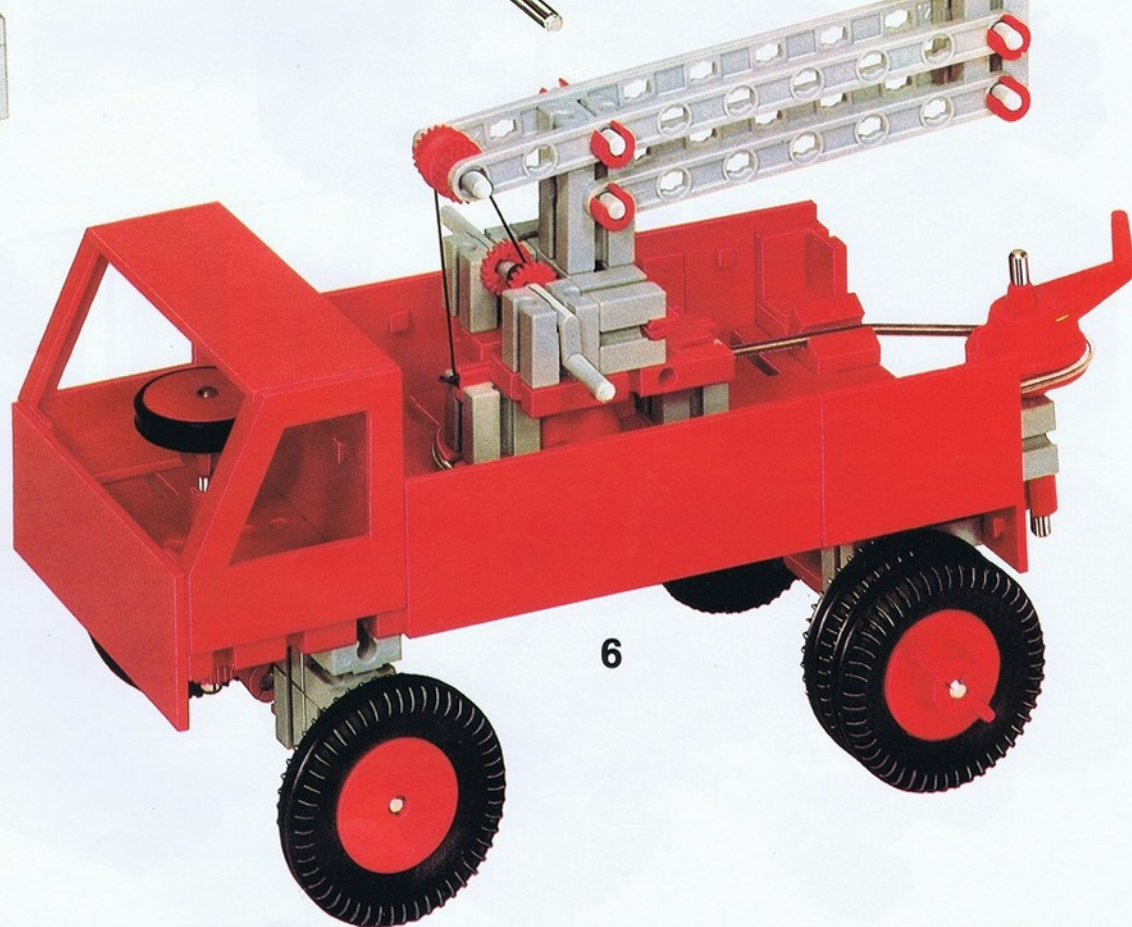
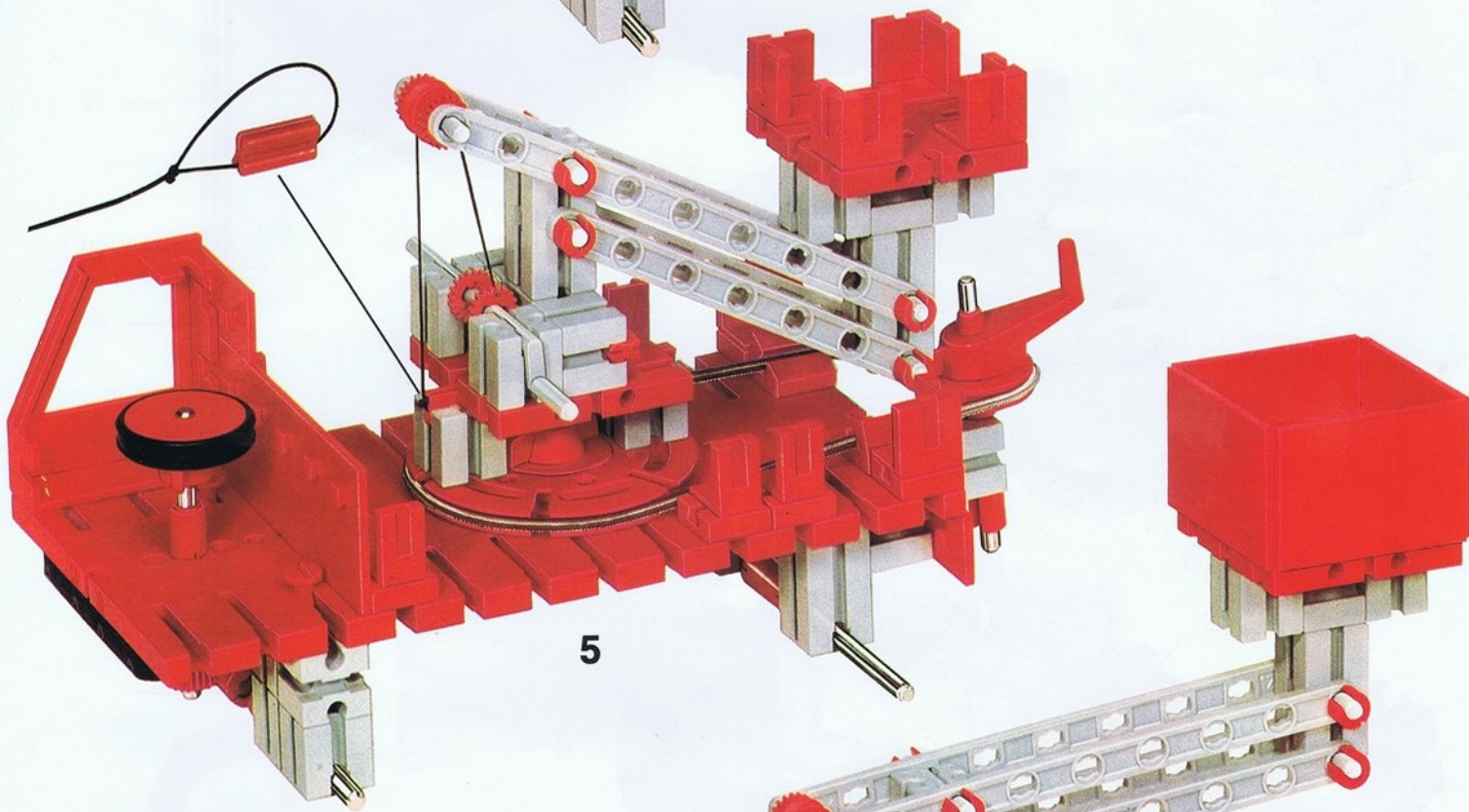
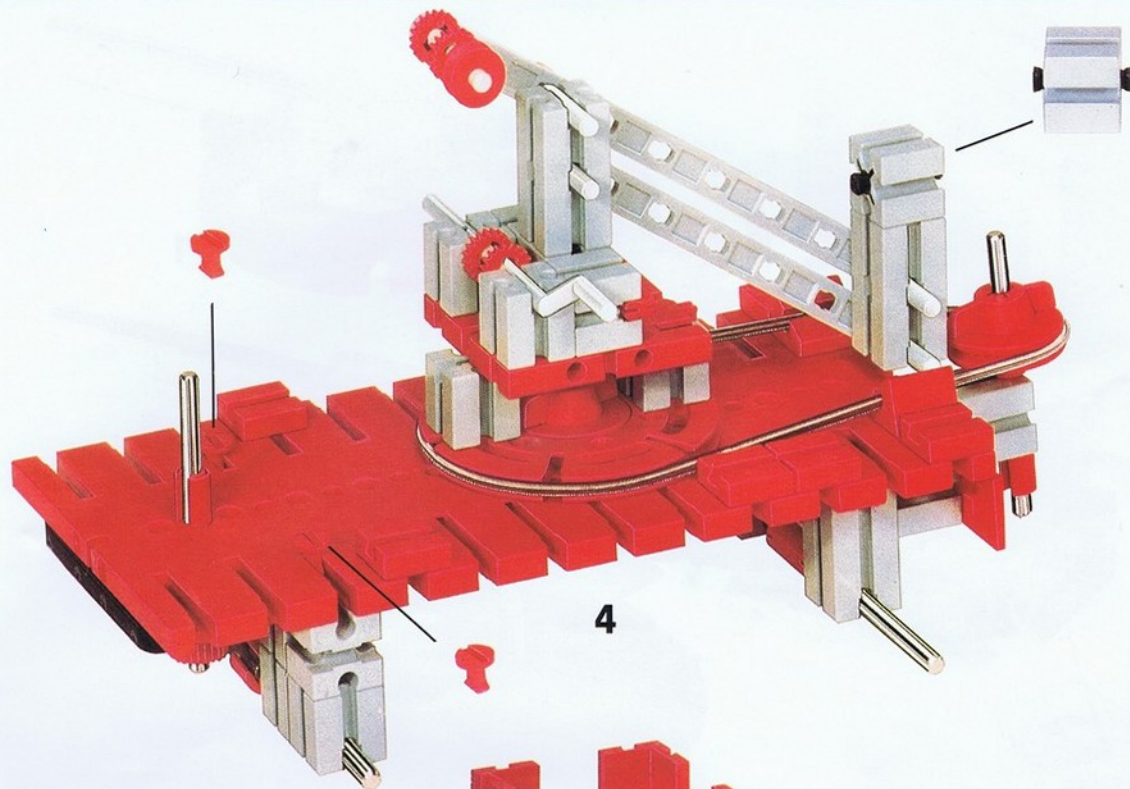

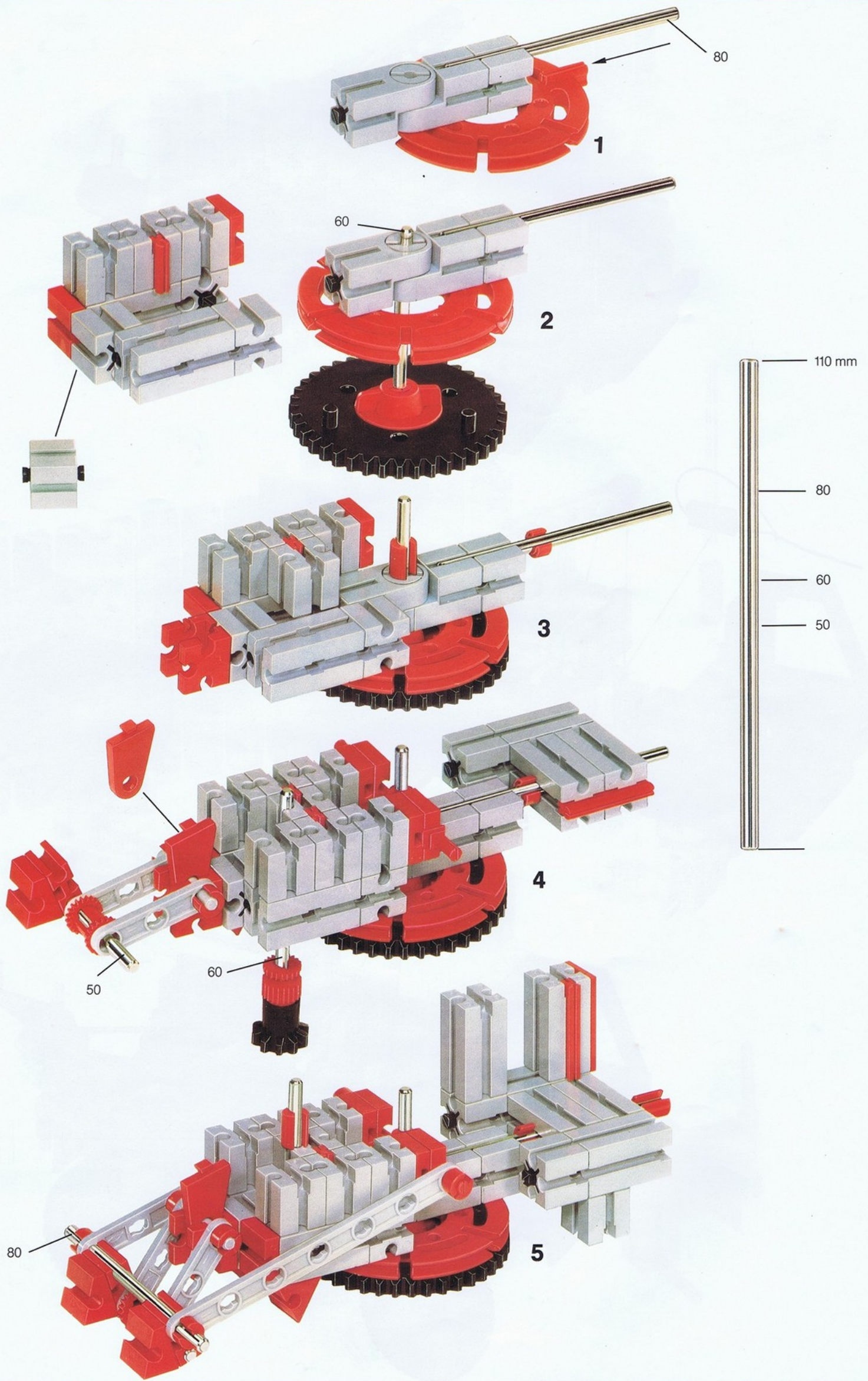

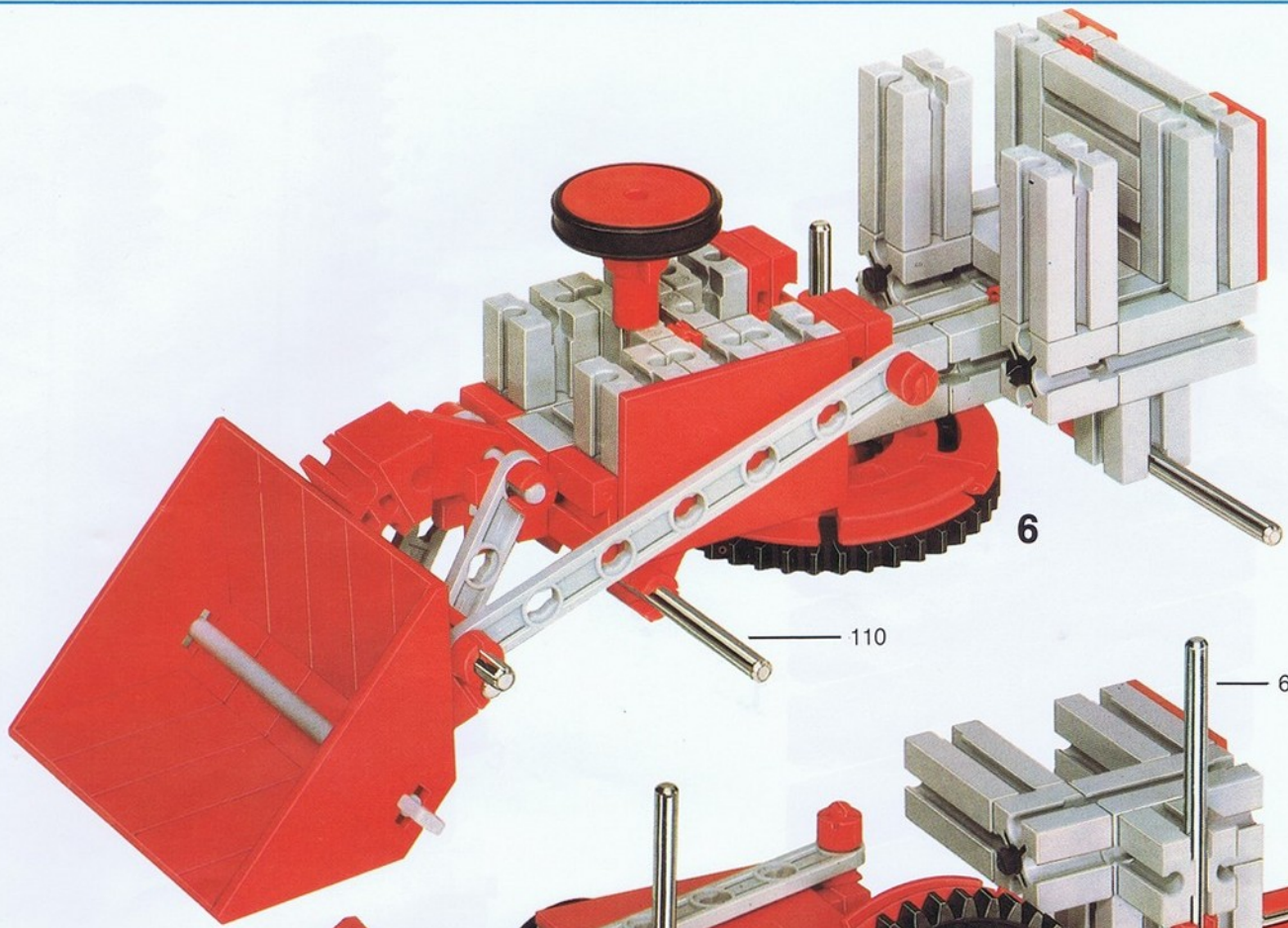

6

110

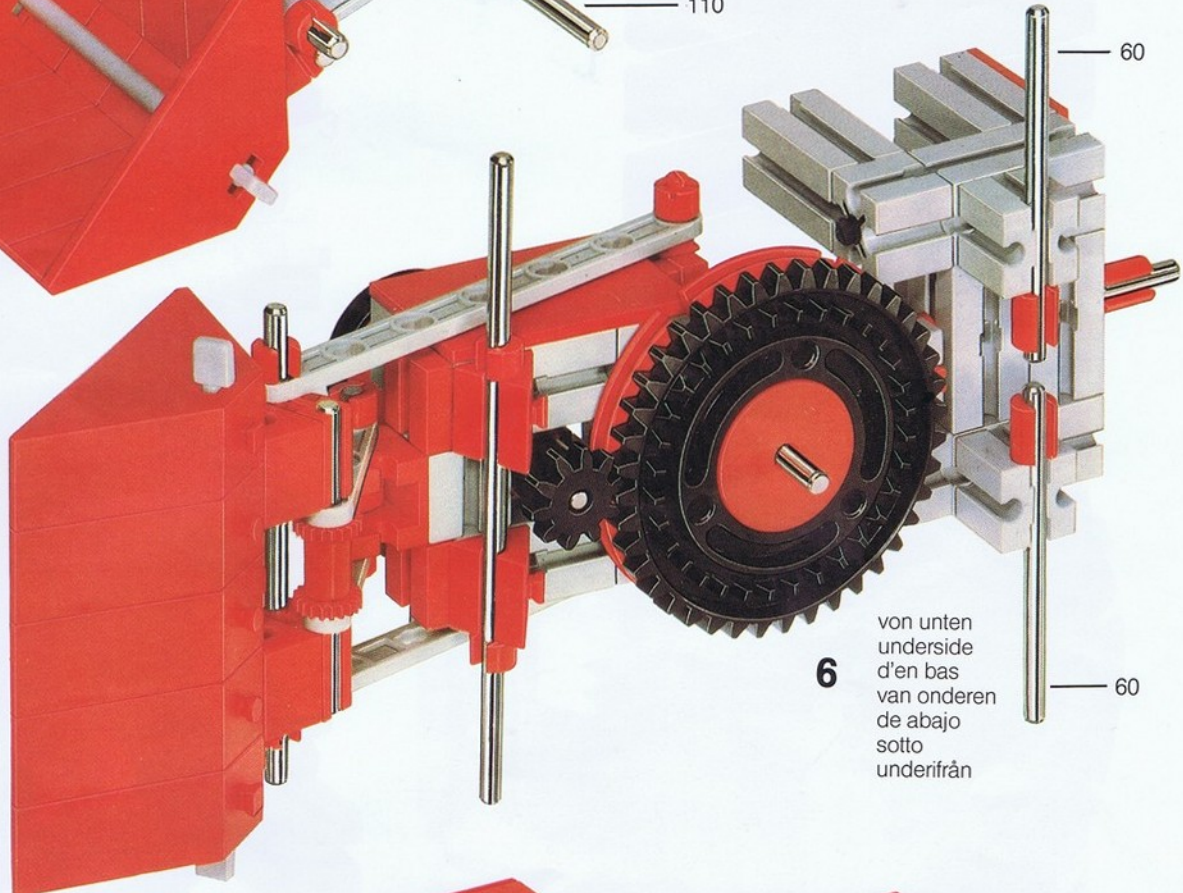

60

6

von unten
underside
d'en bas
van onderen
de abajo
sotto
underifrån

60

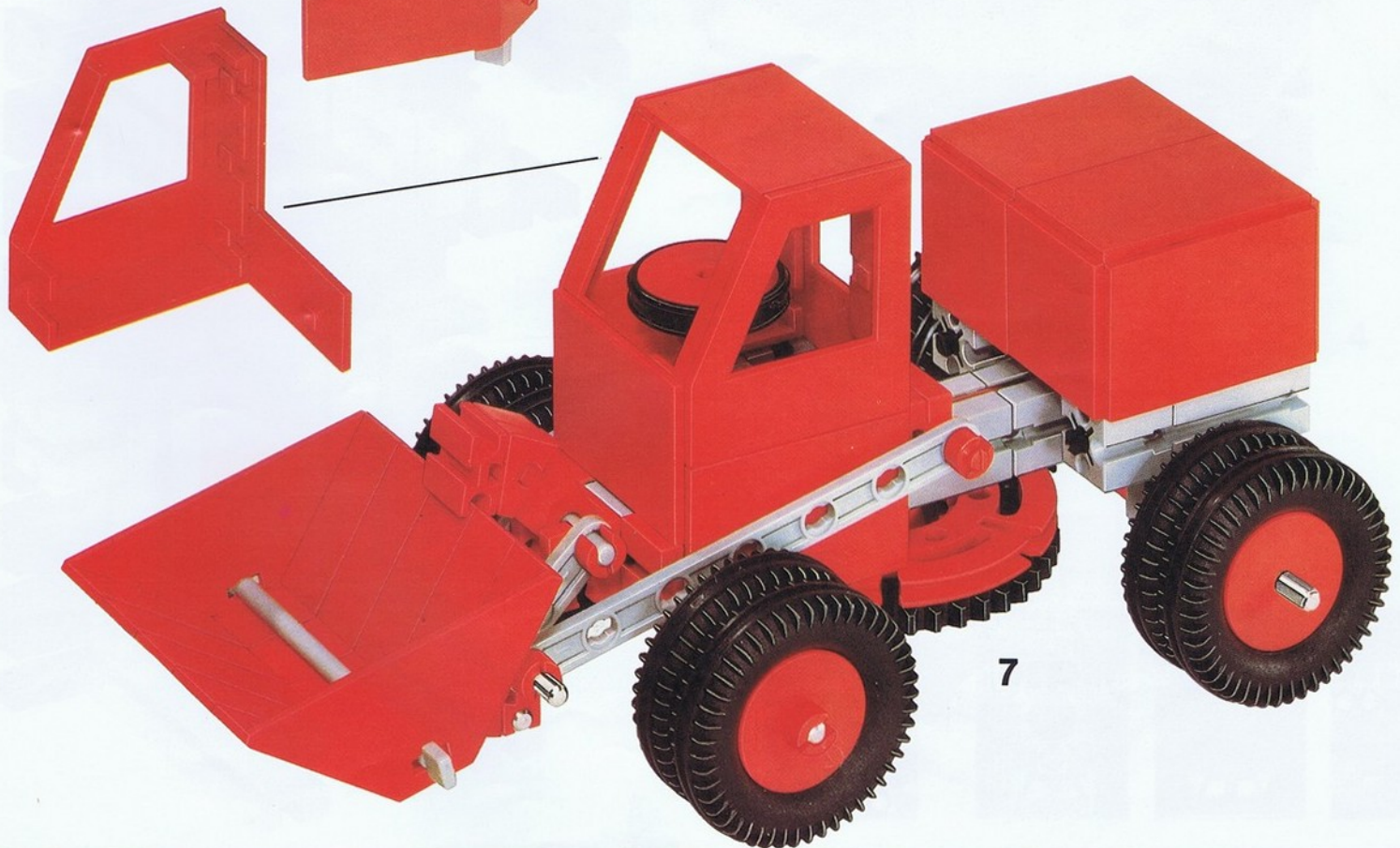

7

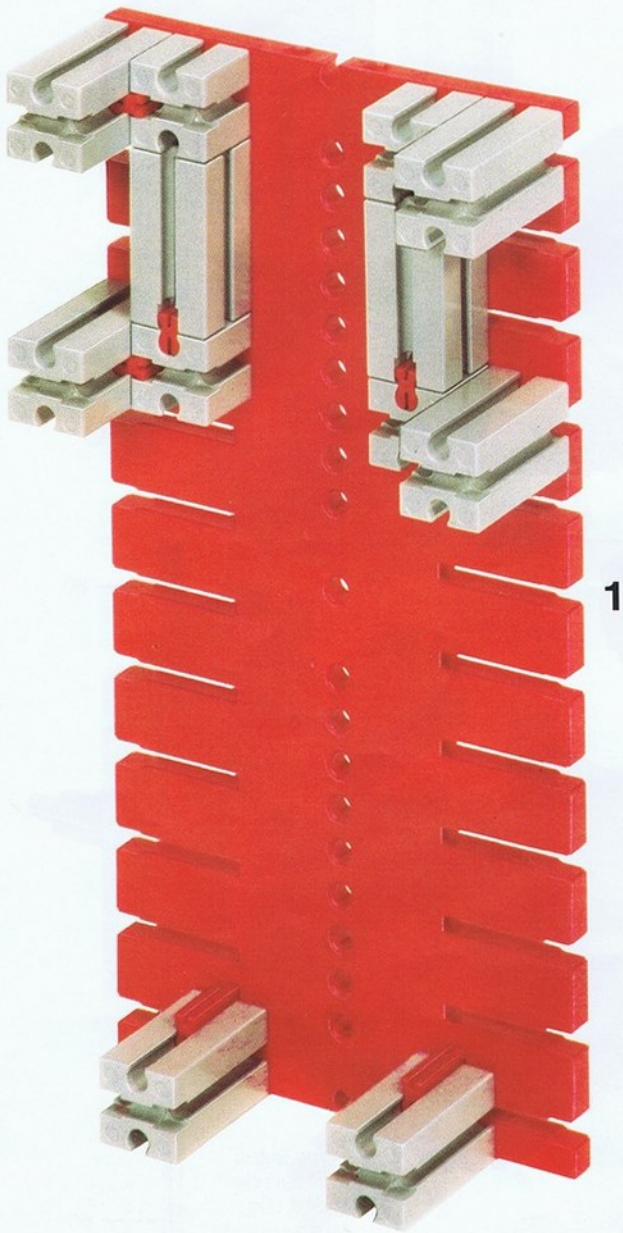

1

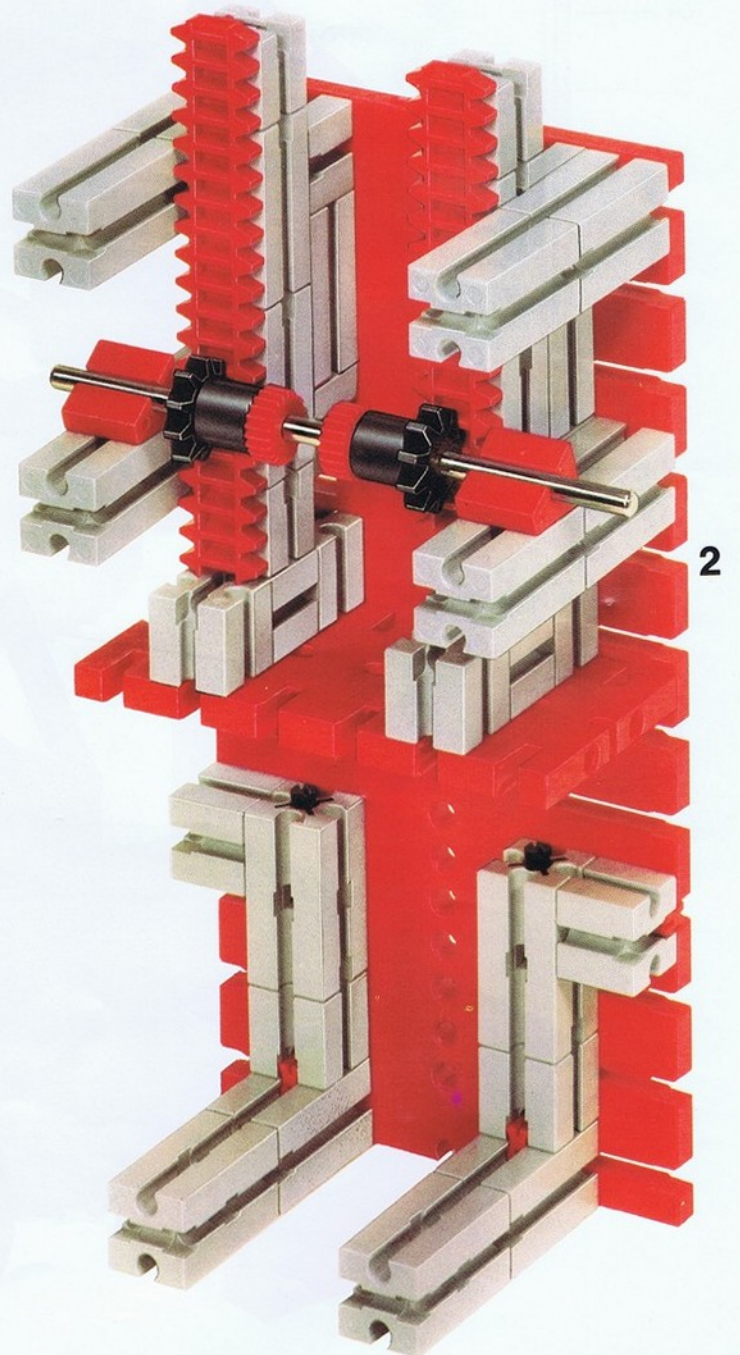
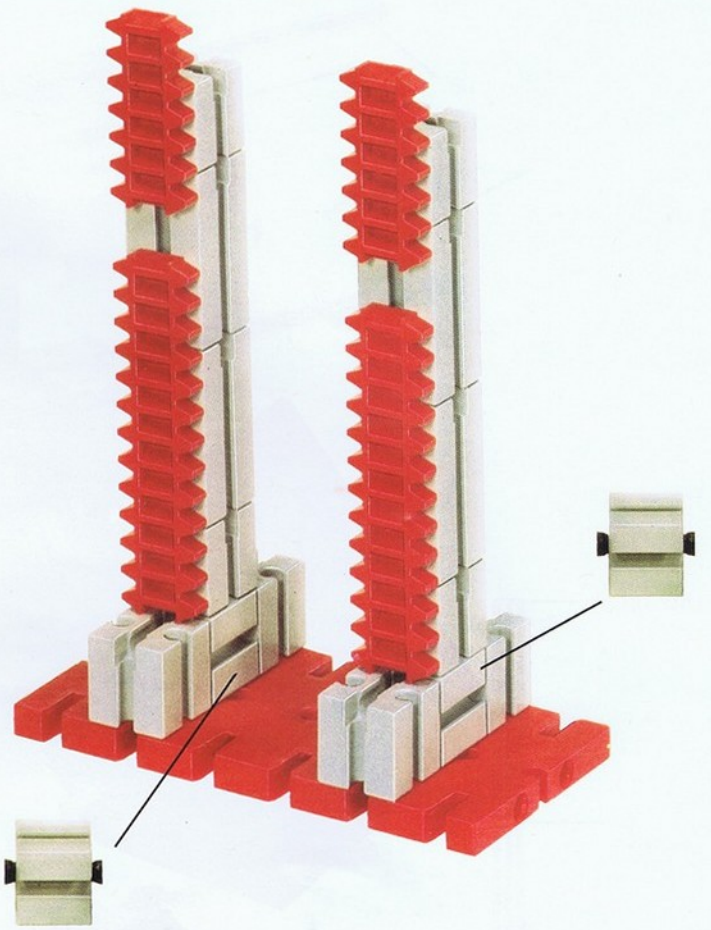

2

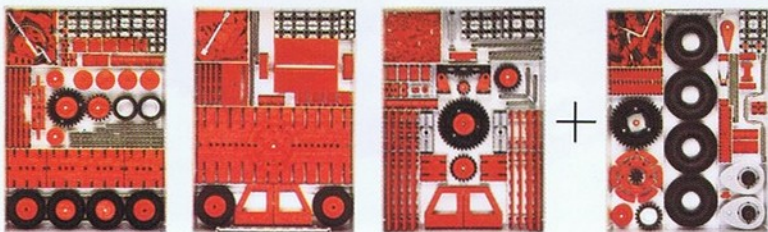

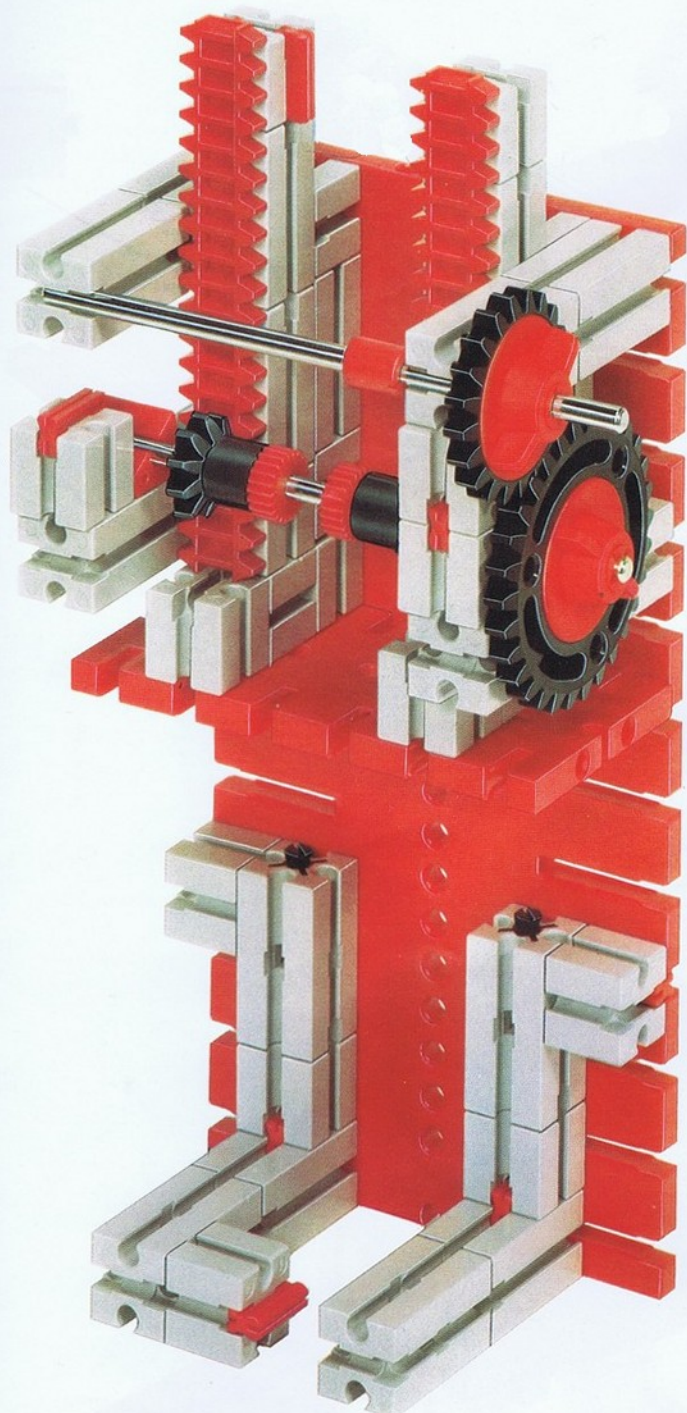

3

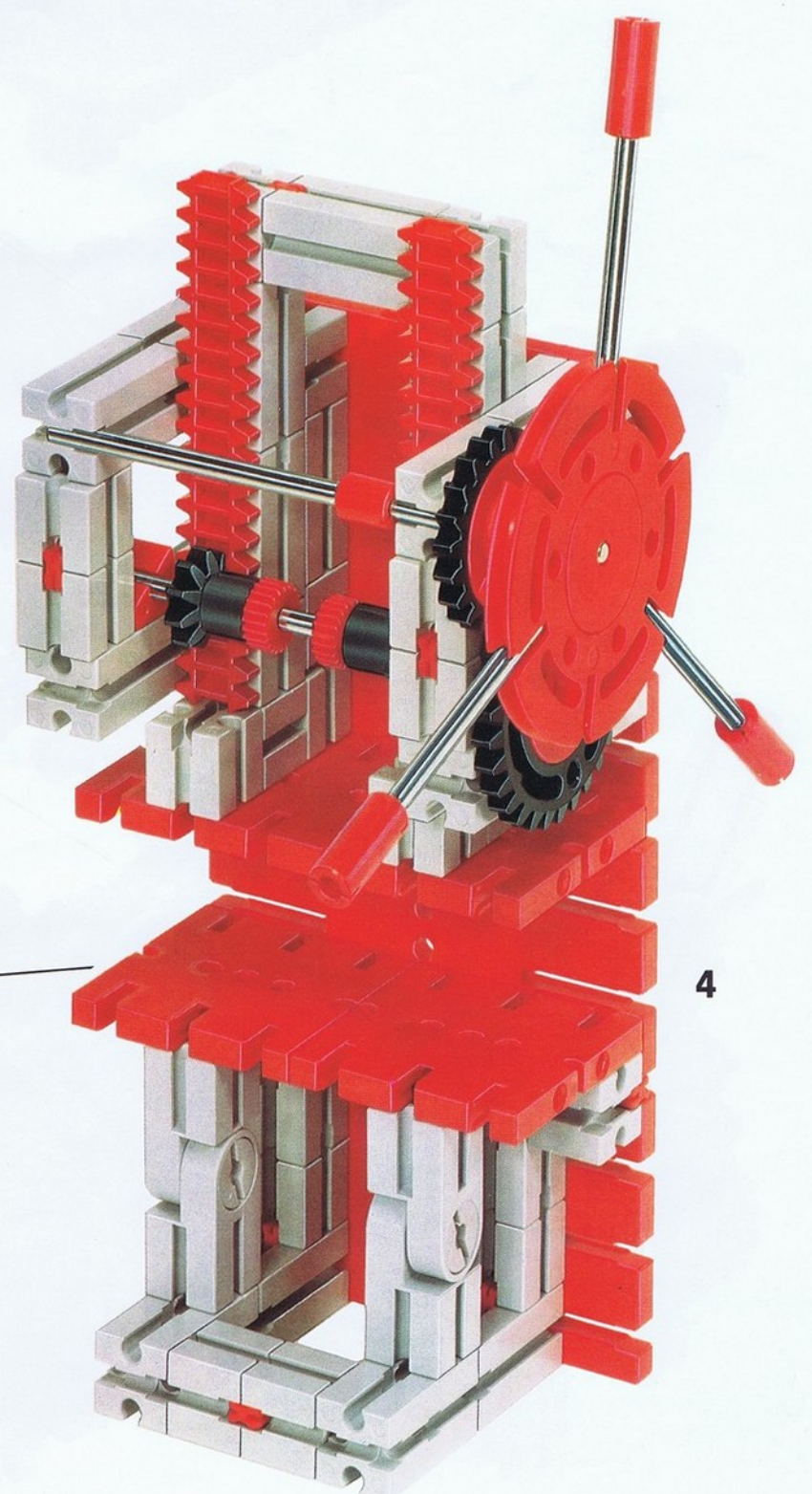

4

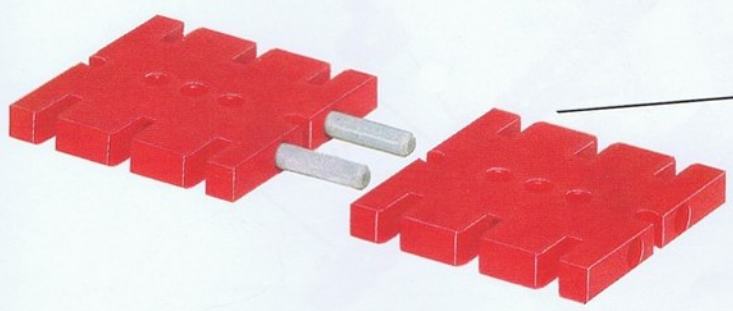

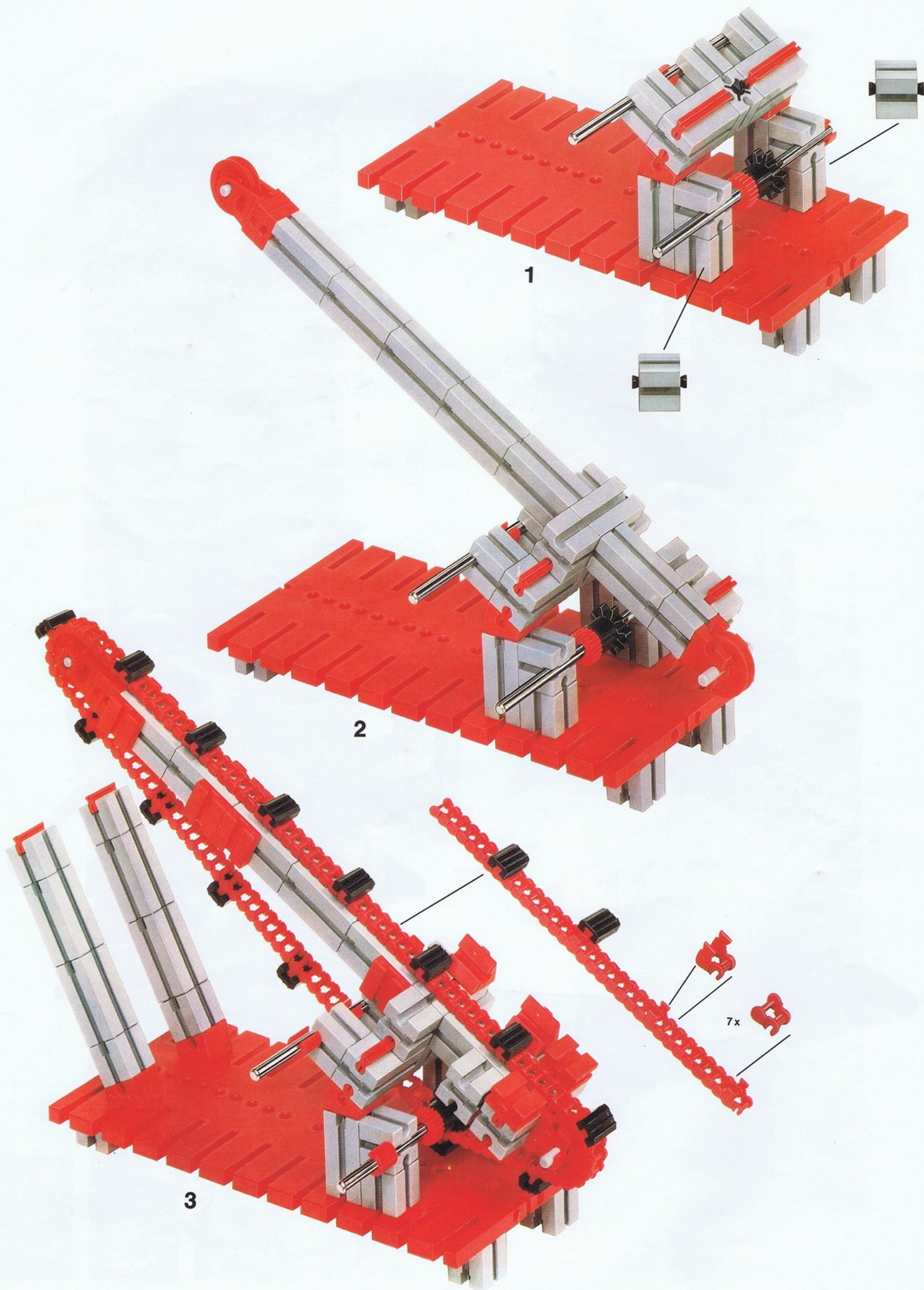

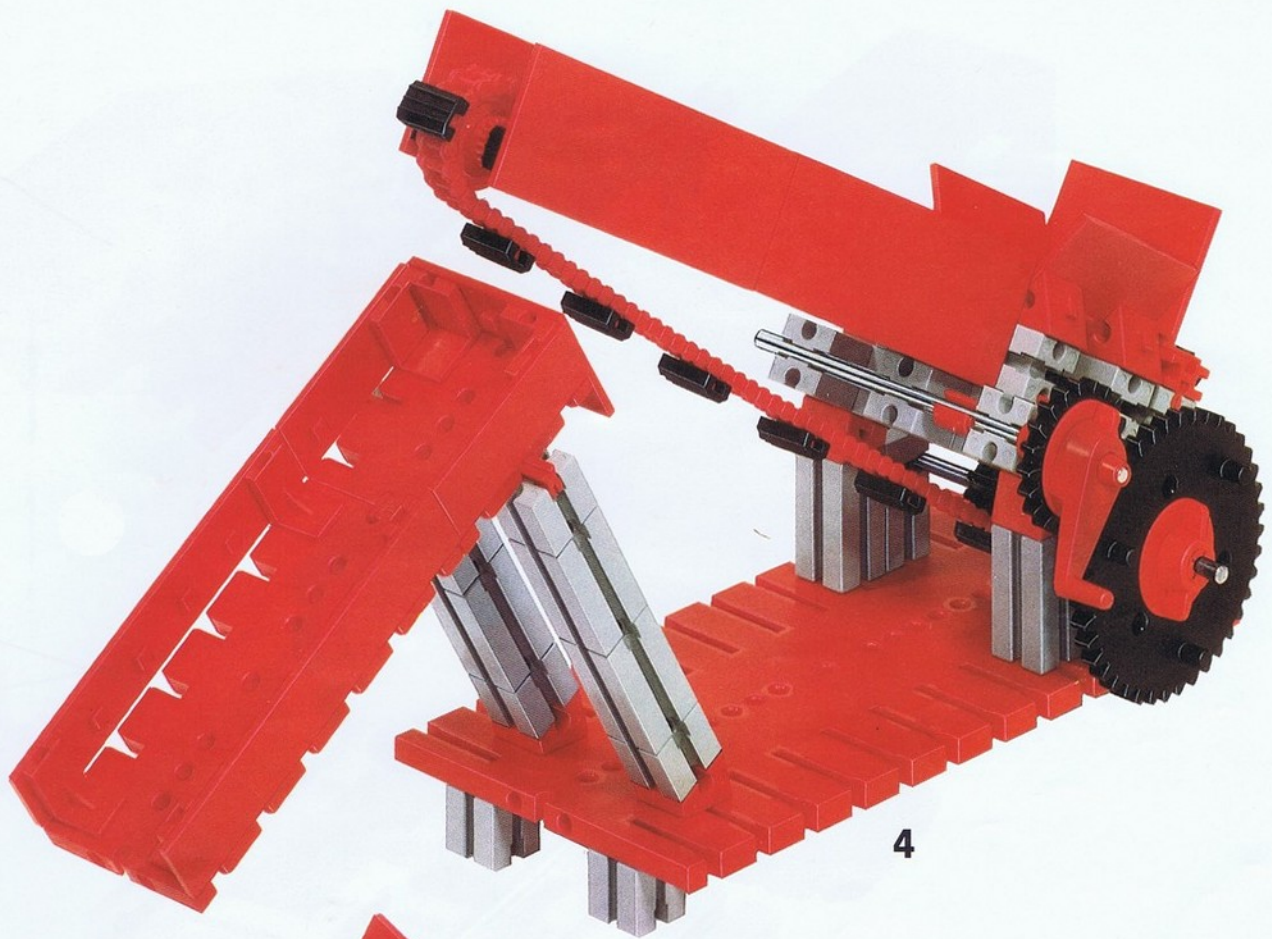

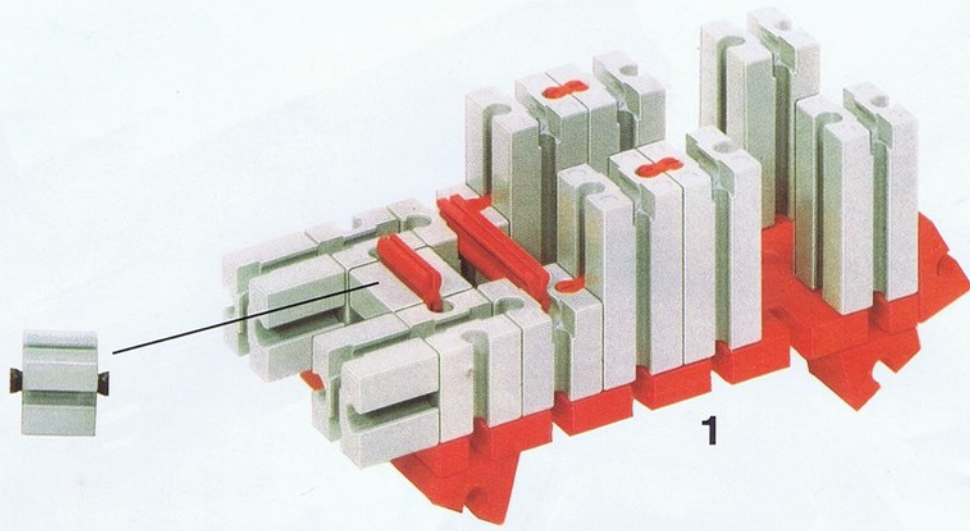

1

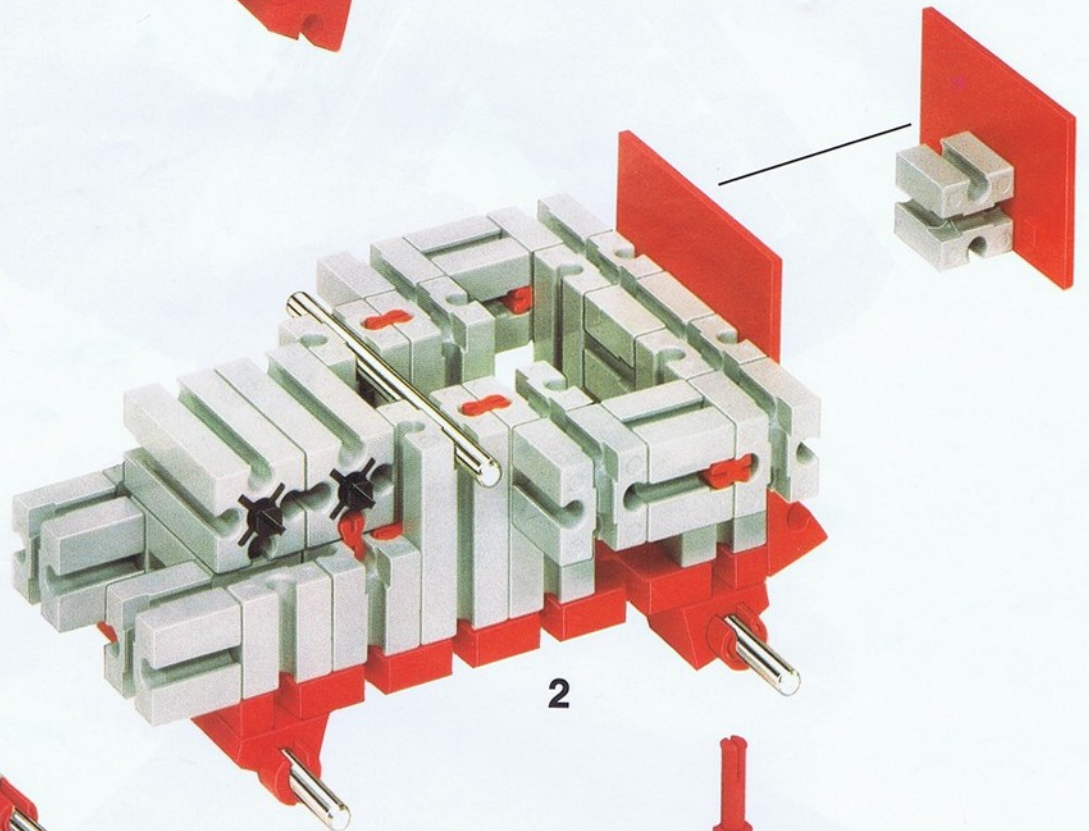

2

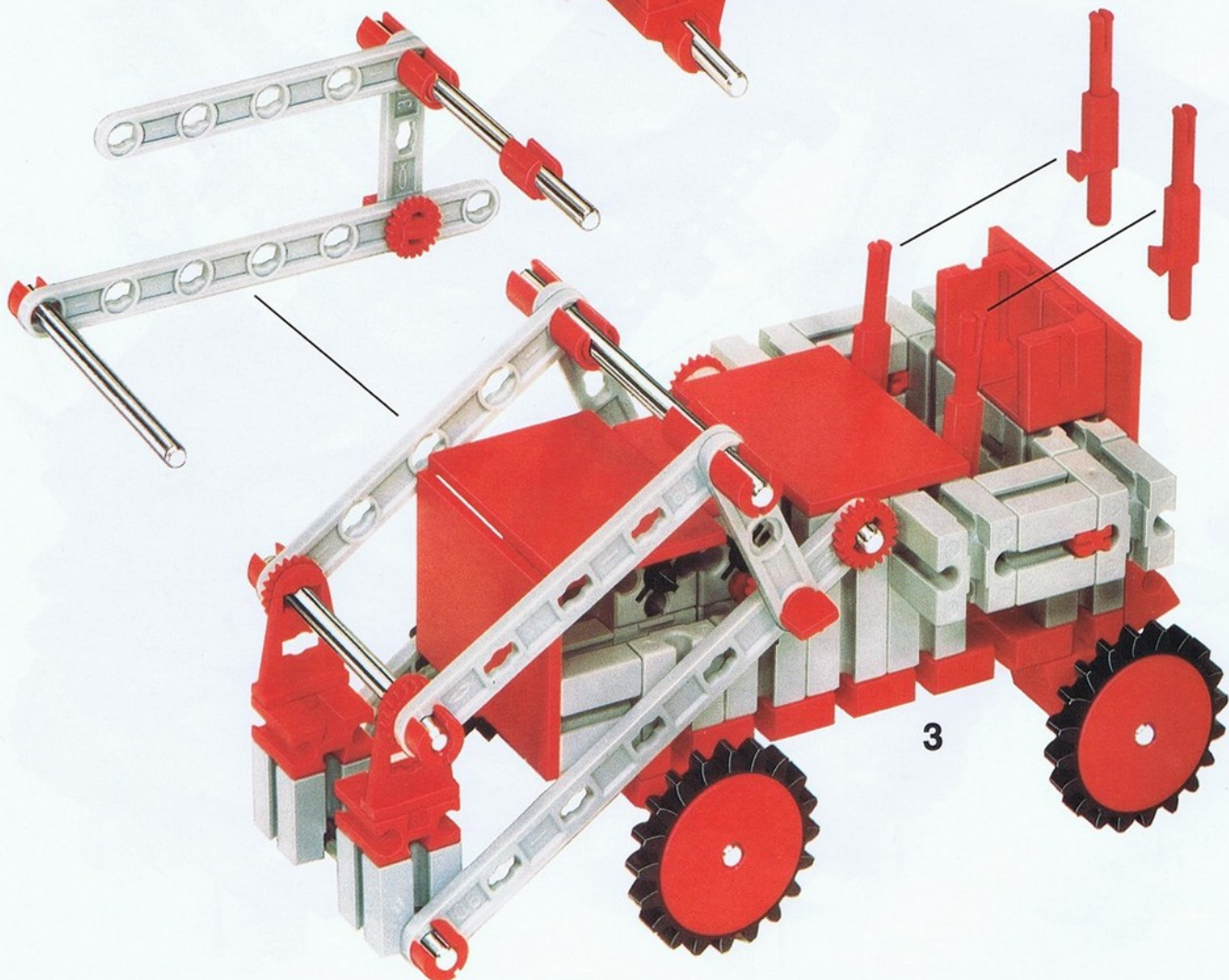

3

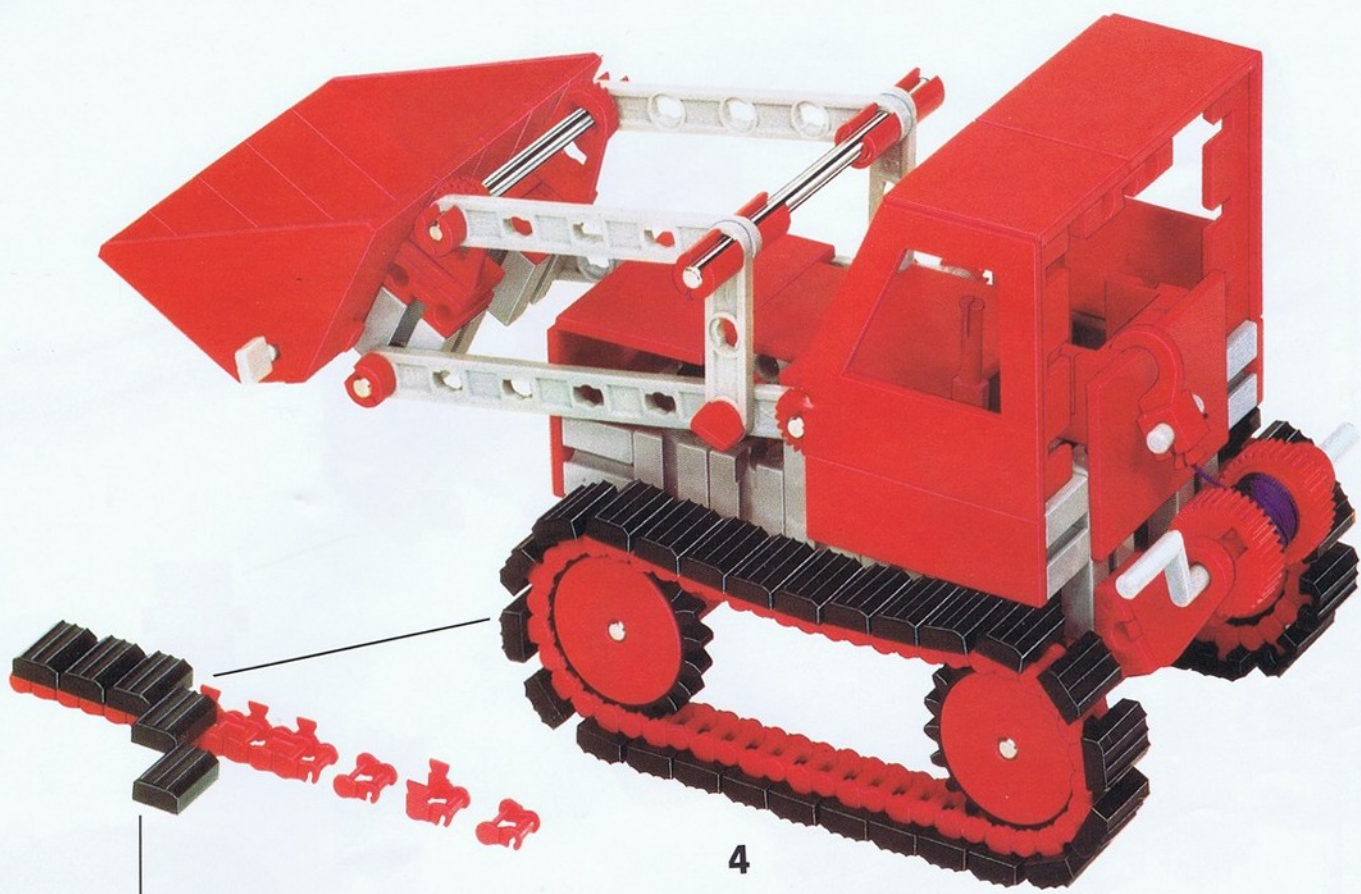

26 x

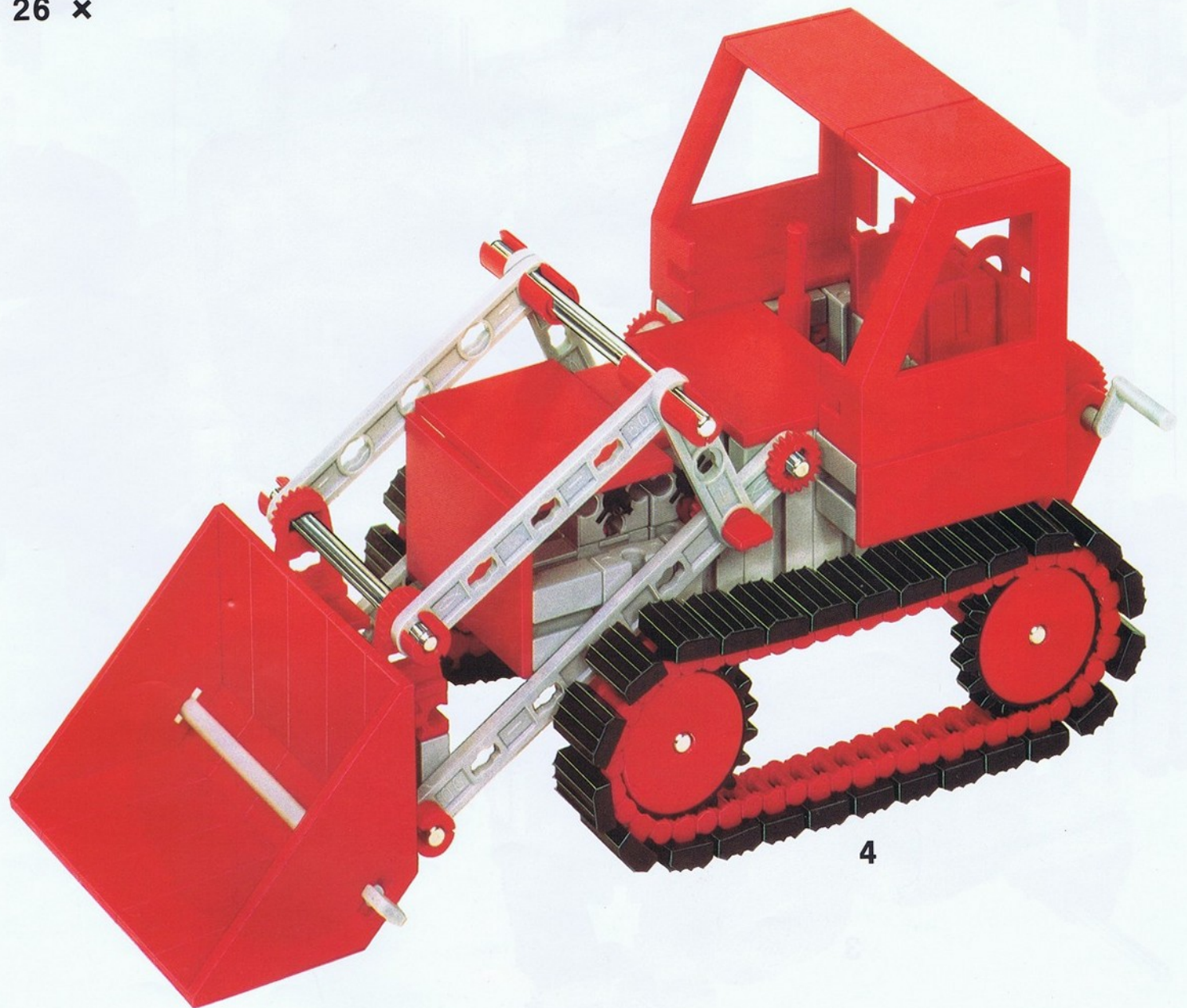

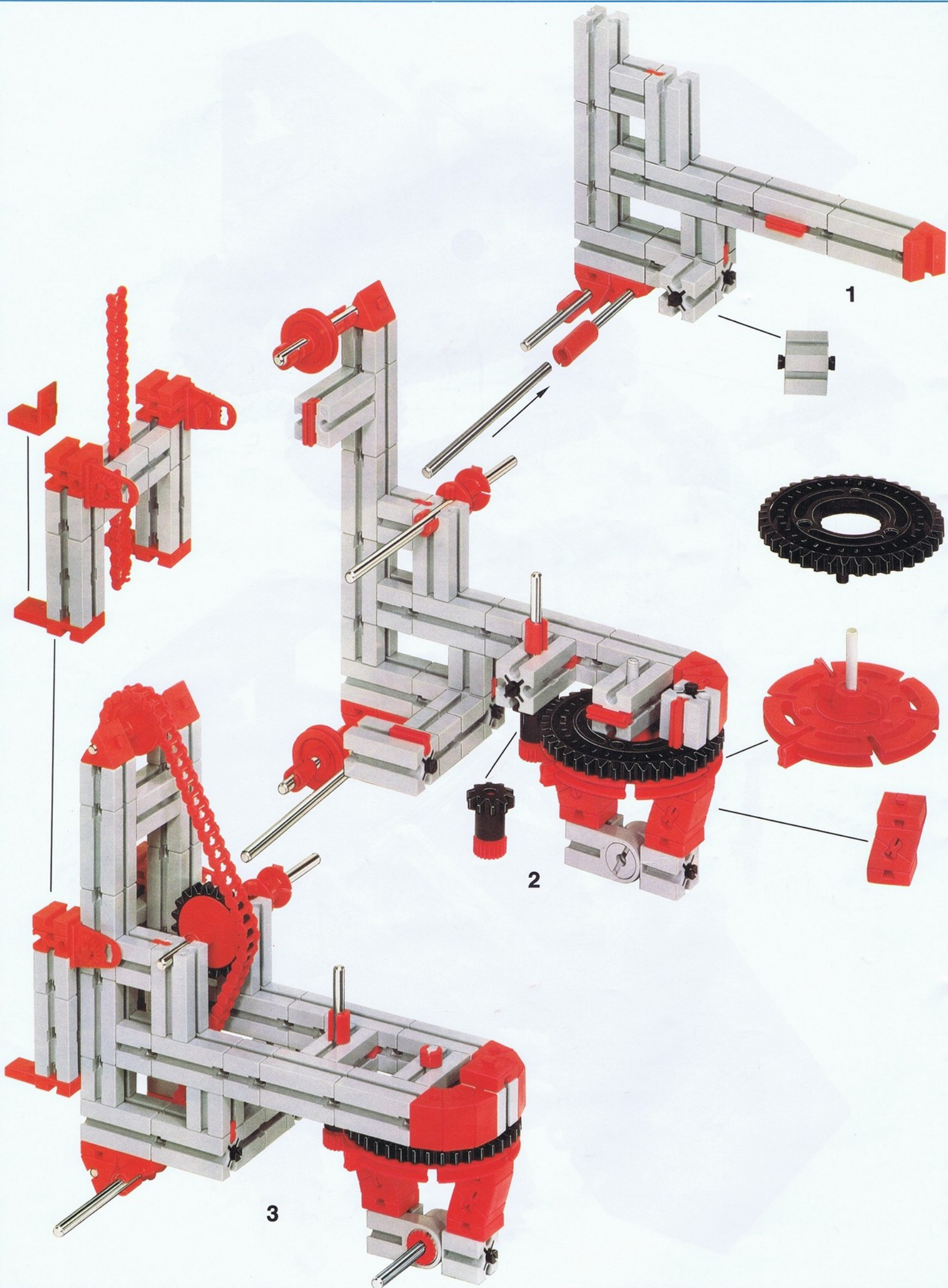

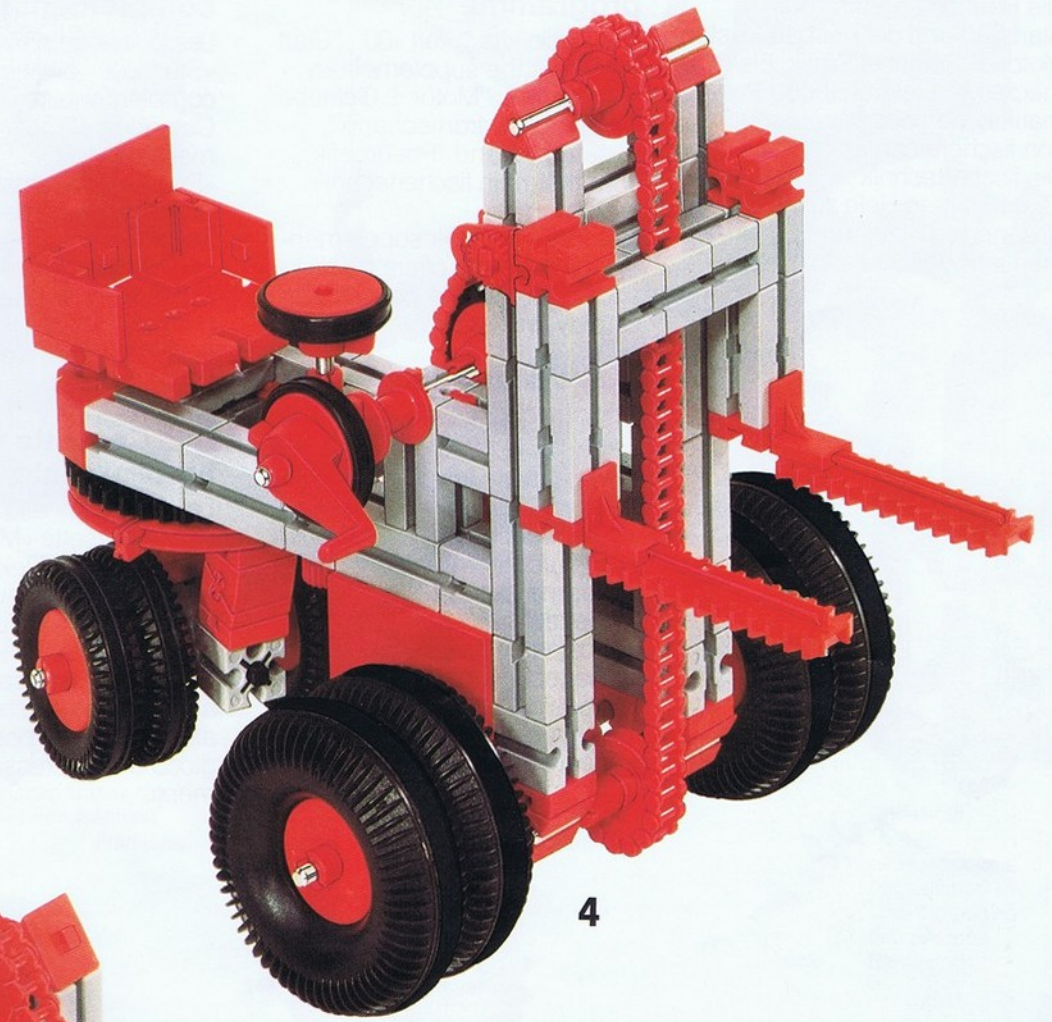
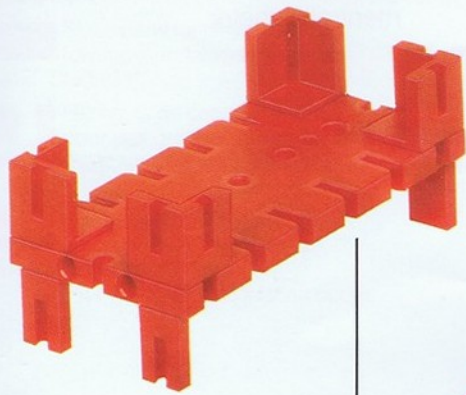

4

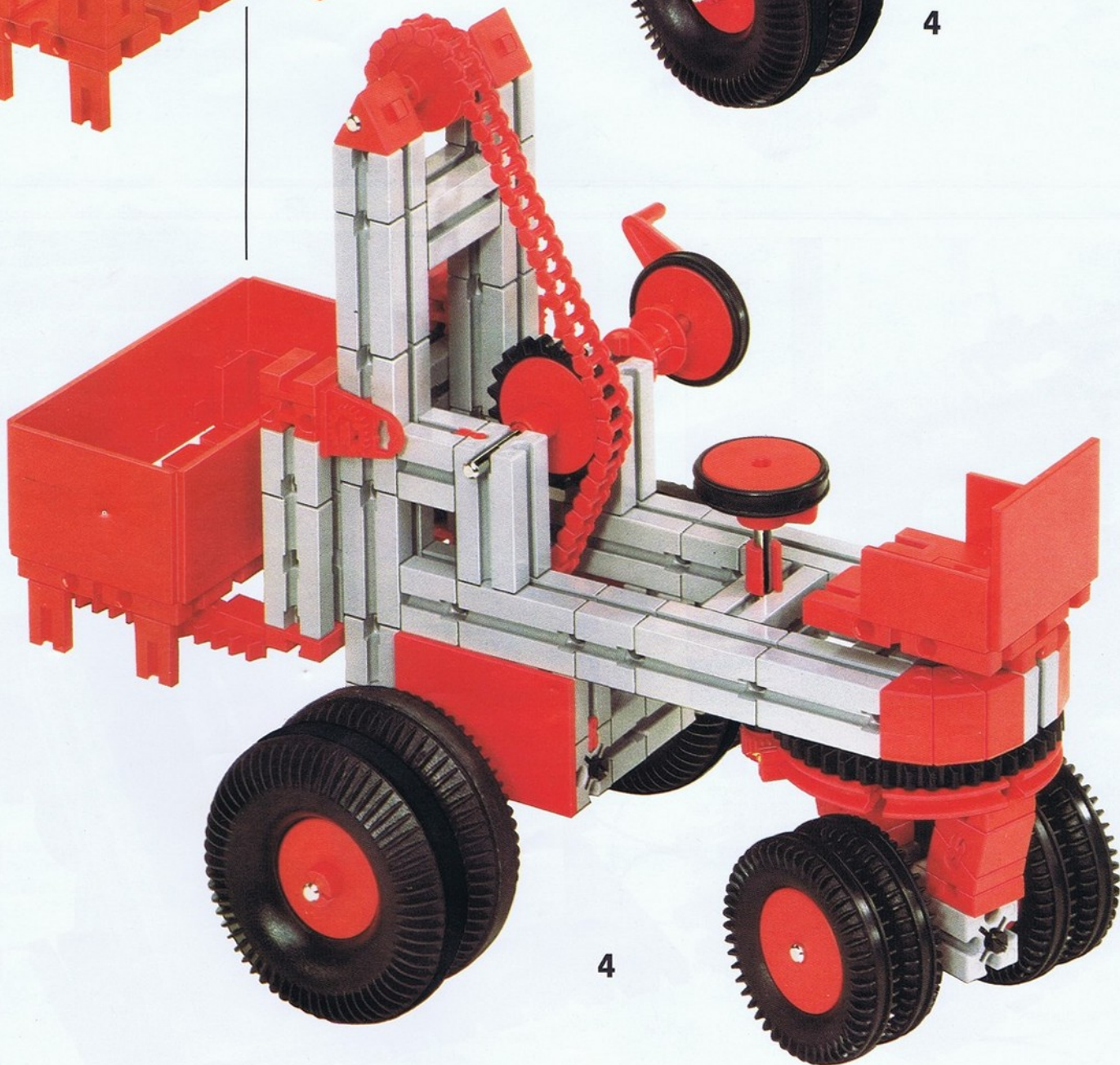

4

Die Ausbau-Kästen

Die Baukästen Start 100, Start 200 und die Ausbau-Kästen Motor + Getriebe, Statik, Elektromechanik, Elektronik und Pneumatik bilden das Kernprogramm von fischertechnik. Die fischertechnik Ausbau-Kästen bieten viele zusätzliche spannende Spiel- und Experimentiermöglichkeiten.

The supplementary programme

The basic kits "Start 100", "Start 200" plus the supplementary programme: "Motor + Getriebe", "Statik", "Elektromechanik", "Elektronik" and "Pneumatik", from the main fischertechnik programme. The fischertechnik supplementary programme offers many additional, exciting possibilities for play and experiment.

Las cajas de ampliación

Las cajas «Start 100», «Start 200» y las cajas de ampliación «Motor + Getriebe», «Statik», «Elektromechanik», «Elektronik» y «Pneumatik» representan el programa esencial de fischertechnik. Las cajas de ampliación de fischertechnik ofrecen numerosas posibilidades adicionales y muy interesantes para jugar y experimentar.

Les boîtes complémentaires

Les boîtes de base «Start 100», «Start 200» ainsi que les boîtes complémentaires «Motor + Getriebe», «Statik», «Elektromechanik», «Elektronik» et «Pneumatik» constituent le programme fondamental fischertechnik. Les boîtes complémentaires fischertechnik offrent de nombreuses possibilités supplémentaires de jeu et d'expérimentation.

Cassette di ampliamento

Lo «Start 100» e lo «Start 200» con le cassette «Motor + Getriebe», «Statik», «Elektromechanik», «Elektronik», «Pneumatik» sono la base centrale del programma fischertechnik. L'aggiunta delle cassette di ampliamento fischertechnik offre altre avvincenti possibilità di gioco e di interessanti esperimenti.

De uitbreidingsdozen

De bouwdozen „Start 100“, „Start 200“ en de uitbreidingsdozen „Motor + Getriebe“, „Statik“, „Elektromechanik“, „Elektronik“ en „Pneumatik“ vormen het basisprogramma van fischertechnik. De fischertechnik uitbreidingsdozen bieden vele extra mogelijkheden om te spelen en te experimenteren.

Utbyggnadslådorna

Bygglådan »Start 100», »Start 200» och utbyggnadslådorna »Motor + Getriebe», »Statik», »Elektromechanik», »Elektronik» och »Pneumatik» är baslådorna i fischertechnik. fischertechnik utbyggnadslådor erbjuder mängder med ytterligare spännande lek- och experimentmöjligheter.





 Motor und viele Getriebe-Elemente. Voraussetzung Start 100. Ab 6 Jahre.

 Motor and gear parts. Prerequisite: "Start 100". From 6 years.

 Moteur et nombreux éléments d'engrenage. «Start 100» indispensable. A partir de 6 ans.

 Motor en aandrijving elementen. Benodigd: „Start 100“. Voor 6 jaar en ouder.

 Motor y muchas elementos de engranaje. La caja «Start 100» es indispensable. A partir de 6 años.

 Motore e molti ingranaggi. È necessario «Start 100». Da 6 anni in poi.

 Motor och många utväxlingsdelar. Förutsättning »Start 100». Från 6 år.

Förderband mit Lastwagen
Conveyor belt and lorry
Tapis rowlant avec camion
Transportband met vrachtwagen
Cinta transportadora con camión
Nastro trasportatore con camion
Transportband med lastbil

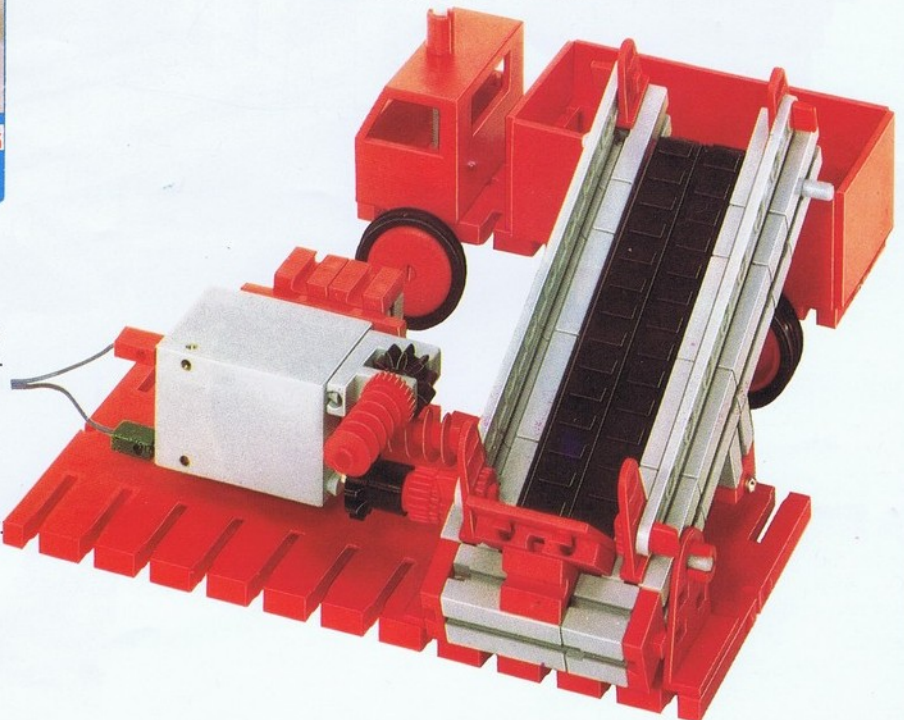



Statik

Ergänzungskasten «Statik-Elemente»
Extension kit "Statics Components"
Boîte complémentaire d'éléments de superstructures
Caja de ampliación d'elementos de estática.

Ab 6 Jahre

From 6 years

A partir de 6 ans

A partir de 6 años

fischertechnik



Statik-Elemente für große Kräne, Türme, Karusselle. Voraussetzung Start 100. Ab 6 Jahre.

Static parts for large cranes, towers, roundabouts. Prerequisite: "Start 100". From 6 years.

Éléments de superstructures pour des grandes grues, tours, manèges. «Start 100» indispensable. A partir de 6 ans.

Statika elementen voor grote kranen, torens, draaimolens. Benodigd: „Start 100”. Voor 6 jaar en ouder.

Elementos estáticos para grandes grúas, torres, carruseles. Caja indispensable «Start 100». A partir de 6 años.

Elementi di statica per grandi gru, torri e giostre. È necessario «Start 100». Da 6 anni in poi.

Statik-delar för stora kranar, torn, broar, karuseller. Förutsättning »Start 100». Från 6 år.

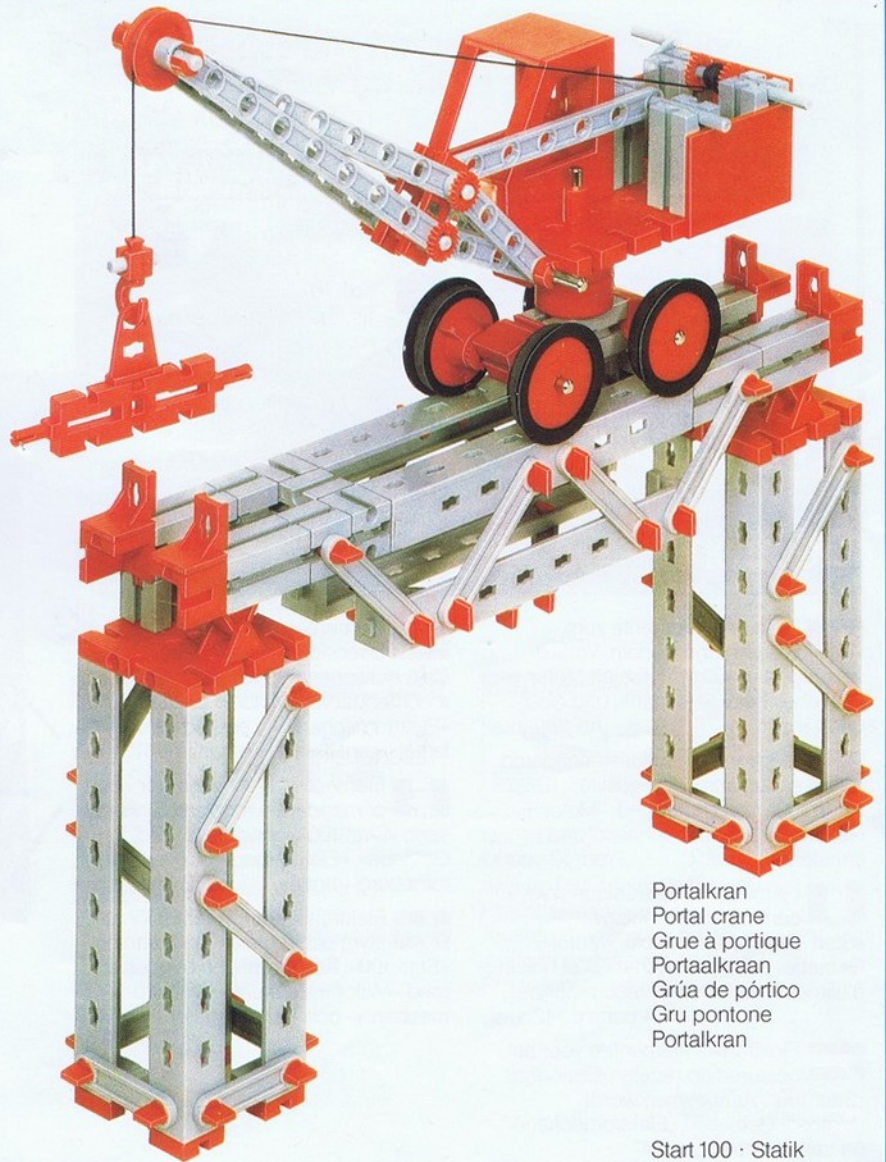

Portalkran
Portal crane
Grue à portique
Portaalkraan
Grúa de pórtico
Gru pontone
Portalkran

Start 100 · Statik



Elektromechanik

Ergänzungskasten «Elektromechanik-Elemente»
Extension kit "Electro-Mechanical Components"
Boîte complémentaire d'éléments d'électromécanique
Caja de ampliación d'elementos de electromecánica.

Ab 10 Jahre

From 10 years

A partir de 10 ans

A partir de 10 años

fischertechnik



Elektromechanik-Elemente zum Schalten und Steuern. Voraussetzung Start 100, empfohlen Motor + Getriebe und Netzgerät mot 4. Ab 10 Jahre.

Electromechanical parts for switching and steering. Prerequisite: "Start 100", recommended: "Motor + Getriebe" and transformer "mot 4". From 10 years.

Éléments d'électromécanique pour commande et régulation. «Start 100» indispensable, «Motor + Getriebe» et boîtier d'alimentation «mot 4» recommandés. A partir de 10 ans.

Elektromechanika elementen voor het schakelen en besturen. Benodigd: „Start 100”. Aanbevolen wordt „Motor + Getriebe” en transformator „mot 4”. Voor 10 jaar en ouder.

Elementos electromecánicos para conexión y Dirección. Caja indispensable «Start 100», cajas recomendadas «Motor + Getriebe» y equipo de alimentación «mot 4». A partir de 10 años.

Elementi di elettromeccanica per commutare e comandare le costruzioni. È necessario «Start 100», consigliato «Motor + Getriebe» e trasformatore «mot 4». Da 10 anni in poi.

Elektromekanik-komponenter för att styra och reglera. Förutsättning »Start 100». Kan lämpligen byggas ut med »Motor + Getriebe» och Transformator »mot 4». Från 10 år.



Blinkanlage
Signal equipment
Installation clignotante
Knipperlicht
Emisor de señales luminosas
Lampeggiatore
Blinkanläggning

Start 100 · Motor + Getriebe · Elektromechanik



Elektronik-Elemente zum Steuern und Regeln. Voraussetzung Start 100, empfohlen Motor + Getriebe, Elektromechanik und Netzgerät mot 4. Ab 12 Jahre.

Electronic parts for steering and controlling. Prerequisite: "Start 100", recommended: "Motor + Getriebe", "Elektromechanik" and transformer "mot 4". From 12 years.

Éléments d'électronique pour commande et réglage. «Start 100» indispensable, «Motor + Getriebe», «Elektromechanik» et boîtier d'alimentation «mot 4» recommandés. A partir de 12 ans.

Elektronika elementen voor het besturen en regelen. Benodigd: „Start 100“. Aanbevolen wordt „Motor + Getriebe“, „Elektromechanik“ en transformator „mot 4“. Voor 12 jaar en ouder.

Elementos electrónicos para Dirección y Regulación. Caja indispensable «Start 100», cajas recomendadas «Motor + Getriebe», «Elektromechanik» y equipo de alimentación «mot 4». A partir de 12 años.

Elementi di elettronica per comandare e regolare. È necessario «Start 100», consigliato «Motor + Getriebe», «Elektromechanik» e trasformatore «mot 4». Da 12 anni in poi.

Elektronik-komponenter för att styra och reglera. Förutsättning »Start 100». Kan lämpligen byggas ut med »Motor + Getriebe», »Elektromechanik» och Transformator »mot 4». Från 12 år.



Elektronischer Morsetaster
Electronic morse key
Manipulateur Morse électronique
Elektronische morsetaster
Manipulador Morse electrónico
Tasto morse elettronico
Elektronisk morseapparat

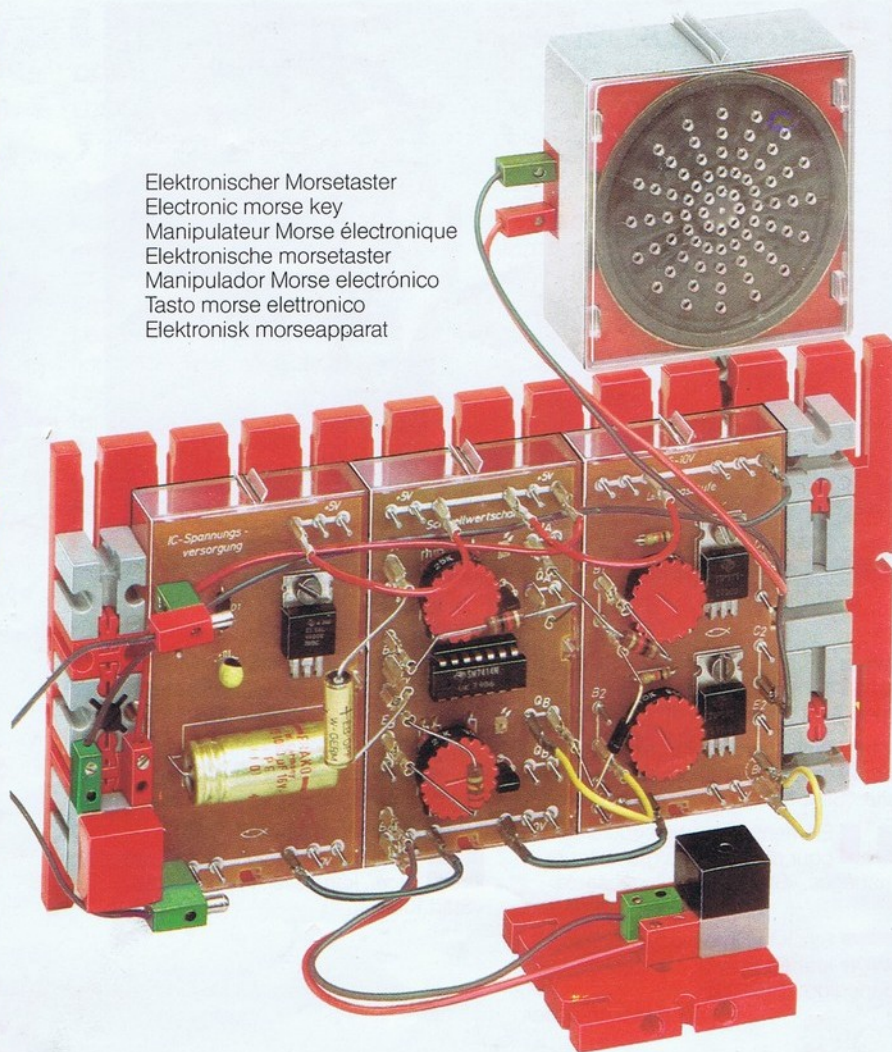

Start 100 · Elektronik



Pneumatik-Elemente der Antriebs- und Steuerungstechnik. Voraussetzung Start 100, empfohlen geeignete Druckluftquelle. Ab 12 Jahre.

Pneumatic parts for power and steering techniques. Prerequisite: "Start 100", recommended: compressed air source. From 12 years.

Éléments de pneumatique pour technique d'entraînement et de commande. «Start 100» indispensable, source d'air comprimé recommandée. A partir de 12 ans.

Pneumatika elementen van aandrijvings- en besturingstechniek. Benodigd: „Start 100“. Aanbevolen wordt beschikbaarheid van samen-geperste lucht. Voor 12 jaar en ouder.

Elementos neumáticos de técnico accionamiento y dirección. Caja indispensable «Start 100», recomendado un equipo de aire comprimido. A partir de 12 años.

Elementi di pneumatica per dare movimento alle costruzioni. È necessario «Start 100» e fonte di aria compressa (compressore). Da 12 anni in poi.

Pneumatik-delar för drivnings- och styrningsteknik. Förutsättning »Start 100». Rekommenderas tryckluft. Från 12 år.



Pneumatische Presse
Pneumatic press
Presse pneumatique
Pneumatische pers
Prensa neumática
Pressa pneumatica
Tryckluftspres

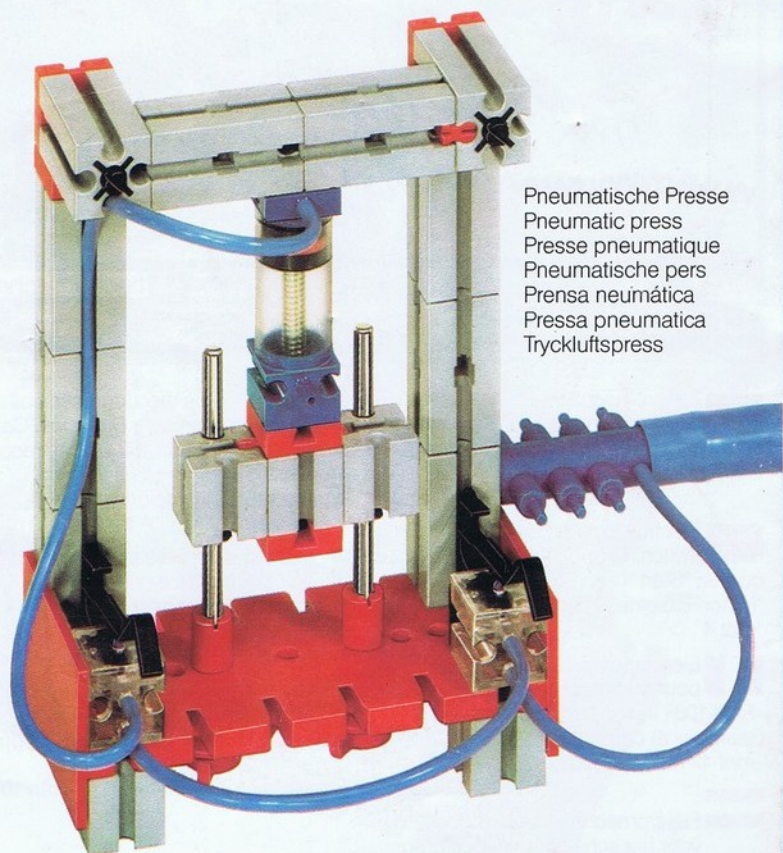

Start 100 · Pneumatik

 Zusatz-Programm

 Additional programme

 Programme complémentaire

 Aanvullings programma

 Programa adicional

 Programma addizionale

 Tillägsprogram

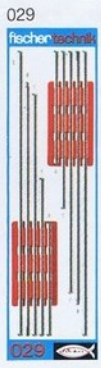
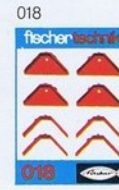

Netzgerät
Transformor
Boîtier d'alimentation
Transformator
Equipo de alimentación
Trasformatore
Transformator

Netzschatgerät
Mains switch
Appareil de commutation d'alimentation
Netschakelaar
Aparato de distribución
Interruttore di contatto
Spänningsnät styraggregat













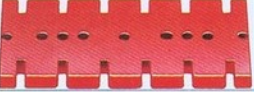

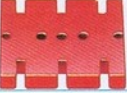
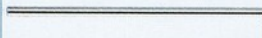
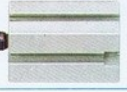

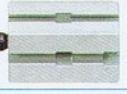





















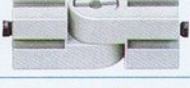





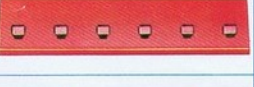

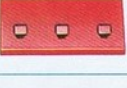

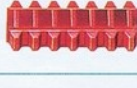

























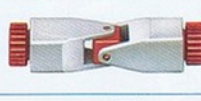



















Karusell
Chairoplane
Manège
Draaimolen
Carrusel
Giostra
Karusell

Start 100 · Motor + Getriebe · Statik





Stückliste · Part List · Nomenclature · Onderdelenlijst	100	100/1	200	200/1	Lista de piezas · Lista dei pezzi · Detalj översikt	100	100/1	200	200/1
 Grundplatte 180 x 90 · Base plate 180 x 90 · Plaque de base 180 x 90 · Basisplaat 180 x 90 · Placa de base 180 x 90 · Piastra base 180 x 90 · Bottenplatta 180 x 90 Art.-Nr. 4 31001 1	●		●		 Winkelachse · Angle axle · Axe coudé · Haakse as · Eje acodado · Asse a gomito · Vinkelaxel Art.-Nr. 4 31035 3			●	●
 Grundplatte 90 x 45 · Base plate 90 x 45 · Plaque de base 90 x 45 · Basisplaat 90 x 45 · Placa de base 90 x 45 · Piastra base 90 x 45 · Bottenplatta 90 x 45 Art.-Nr. 4 36576 1	●		●		 Kurbelwelle · Cranked axle · Vilebrequin · Krukas · Cigüeñal · Albera a gomito · Vevaxel Art.-Nr. 4 31080 3				●
 Grundplatte 45 x 45 · Base plate 45 x 45 · Plaque de base 45 x 45 · Basisplaat 45 x 45 · Placa de base 45 x 45 · Piastra base 45 x 45 · Bottenplatta 45 x 45 Art.-Nr. 4 36593 1	●		●		 Achse 110 · Axle 110 · Axe 110 · As 110 · Eje 110 · Asse 110 · Axel 110 Art.-Nr. 4 31031 3			●	●
 Baustein 30 · Building block 30 · Pierre grise de 30 · Bouwsteen 30 · Bloque constructivo 30 · Modulo 30 · Byggnadssten 30 Art.-Nr. 3 31003 1	●	●	●	●	 Achse 80 · Axle 80 · Axe 80 · As 80 · Eje 80 · Asse 80 · Axel 80 Art.-Nr. 4 37384 3		●	●	●
 Baustein 30 mit Bohrung · Building block 30 with bore · Pierre grise de 30 percée · Bouwsteen 30 met boring · Bloque constructivo 30 con taladro · Modulo 30 forato · Byggnadssten 30 med borrhål Art.-Nr. 3 31004 1	●		●		 Achse 60 · Axle 60 · Axe 60 · As 60 · Eje 60 · Asse 60 · Axel 60 Art.-Nr. 4 31032 3		●	●	●
 Baustein 15 · Building block 15 · Pierre grise de 15 · Bouwsteen 15 · Bloque constructivo 15 · Modulo 15 · Byggnadssten 15 Art.-Nr. 3 31005 1	●	●	●		 Achse 50 · Axle 50 · Axe 50 · As 50 · Eje 50 · Asse 50 · Axel 50 Art.-Nr. 4 31033 3		●		●
 Baustein 15 mit 2 Zapfen · Block 15 with 2 pins · Pierre grise de 15 à 2 tenons · Bouwsteen 15 med 2 nokken · Bloque constructivo 15 con 2 pivotes · Modulo 15 a 2 perni · Byggnadssten 15 med 2 tappar Art.-Nr. 3 31006 1	●	●	●		 Kunststoffachse 30 · Plastic axle 30 · Axe plastique 30 · K-as 30 · Eje de plástico 30 · Asse in plastica 30 · Axel av syntetmaterial 30 Art.-Nr. 4 38413 1		●		●
 Baustein 15 mit rundem Zapfen · Building block 15 with round lug · Pierre grise de 15 à tourillon · Bouwsteen 15 met ronde nok · Bloque constructivo 15 con pivote redondo · Modulo 15 con perno rotondo · Byggnadssten 15 med runda tappar Art.-Nr. 3 31009 1	●		●	●	 Reifen 60 mit Gummiring · Tyre 60 with rubber ring · Pneu de 60 avec élastique · Band 60 met rubbering · Neumático 60 con anillo de goma · Pneumatico 60 con elastico · Däck 60 med gummiring – Art.-Nr. 3 38566 1				●
 Baustein 15 mit 2 runden Zapfen · Double ended block 15 with round pins · Pierre grise 15 à 2 tourillons · Bouwsteen 15 met 2 ronde nokken · Elemento constructivo 15 con 2 pivotes redondos · Modulo 15 a 2 perni rotondi · Byggnadssten 15 med 2 runda tappar – Art.-Nr. 3 31007 1	●		●	●	 Reifen 45 · Tyre 45 · Pneu 45 · Wielband 45 · Neumático 45 · Pneumatico 45 · Däck 45 Art.-Nr. 4 31018 1		●		●
 Baustein 7,5 · Building block 7,5 · Pierre rouge de 7,5 · Bouwsteen 7,5 · Bloque constructivo 7,5 · Modulo 7,5 · Byggnadssten 7,5 Art.-Nr. 4 37468 1	●	●	●		 Gummiring 37 x 2,5 · Rubber ring 37 x 2,5 · Elastique 37 x 2,5 · Rubbering 37 x 2,5 · Anillo de goma 37 x 2,5 · Elastico 37 x 2,5 · Gummiring 37 x 2,5 Art.-Nr. 4 36051 7		●		●
 Baustein 5 · Building block 5 · Pierre rouge de 5 · Bouwsteen 5 · Bloque constructivo 5 · Modulo 5 · Byggnadssten 5 Art.-Nr. 4 37237 1	●	●	●		 Reifen 30 · Tyre 30 · Pneu 30 · Wielband 30 · Neumático 30 · Pneumatico 30 · Däck 30 Art.-Nr. 4 31017 1		●		●
 Winkelstein gleichschenkelig · Angle block, isosceles · Pierre rouge angulaire isocèle · Hoeksten met gelijke benen · Bloque angular isósceles · Modulo angular isoscele · Vinkelsten, rätvinklig – Art.-Nr. 4 31011 1	●	●	●		 Flachnabe · Flat hub · Moyeu plat · Platte naaf · Cubo plano · Mozzo piatto · Plattnav Art.-Nr. 3 31015 1		●	●	●
 Winkelstein gleichseitig · Angle block · Pierre rouge angulaire équilateral · Hoeksteen gelijkzijdig · Bloque angular equilátero · Modulo angular equilátero · Vinkelsten, liksidig Art.-Nr. 4 31010 1	●		●	●	 Rad 23 · Wheel 23 · Roue 23 · Wiel 23 · Rueda 23 · Ruota 23 · Hjul 23 Art.-Nr. 4 36581 1		●		●
 Baustein V 15 Eck · Building block V 15 corner · Pierre V 15 d'angle · Hoekbouwsteen V 15 · Bloque de construcción V 15 de ángulo · Modulo d'angolo V 15 · Hörnbyggssten V 15 Art.-Nr. 4 38240 1	●		●		 Radachse · Stub axle · Axe de roue · Wiel as · Eje de rueda · Asse per ruota · Hjul axel Art.-Nr. 4 36586 1		●		●
 Winkelstein 10 x 15 x 15 · Angle block 10 x 15 x 15 · Pierre rouge angulaire 10 x 15 x 15 · Hoeksteen 10 x 15 x 15 · Bloque angular 10 x 15 x 15 · Modulo angular 10 x 15 x 15 · Vinkelsten 10 x 15 x 15 Art.-Nr. 4 38423 1	●	●	●		 Drehscheibe ϕ 60 · Large pulley wheel ϕ 60 · Couronne de poulie ϕ 60 · Draaischijf ϕ 60 · Polea giratoria ϕ 60 · Corona puleggia ϕ 60 · Svängskiva ϕ 60 Art.-Nr. 4 31019 1		●		●
 Gelenkstein · Hinged block · Pierre grise articulée · Scharnierstein · Bloque articulado · Elemento articolato · Ledsten Art.-Nr. 3 31008 1	●		●		 Zahnrad Z 40/32 · Gear wheel Z 40/32 · Couronne à Z 40/32 · Tandwiel Z 40/32 · Rueda dentada Z 40/32 · Ruota dentata Z 40/32 · Kuggjul Z 40/32 Art.-Nr. 4 31022 1			●	●
 Gelenkstein 15 · Hinged block 15 · Pierre rouge 15 articulée · Scharnierstein 15 · Bloque articulado 15 · Elemento articolato 15 · Länksten 15 Art.-Nr. 3 38459 1	●		●		 Zahnrad Z 30 · Gear wheel Z 30 · Couronne à 30 dents · Tandwiel Z 30 · Rueda dentada Z 30 · Ruota dentata Z 30 · Kuggjul Z 30 Art.-Nr. 4 36264 1		●		●
 Zwischenstück 5 x 15 x 30 · Connector 5 x 15 x 30 · Raccord 5 x 15 x 30 · Tussenstuk 5 x 15 x 30 · Conector 5 x 15 x 30 · Connettore 5 x 15 x 30 · Mellandel 5 x 15 x 30 Art.-Nr. 4 38424 1	●		●		 Zahnrad Z 20 · Gear wheel Z 20 · Couronne à 20 dents · Tandwiel Z 20 · Rueda dentada Z 20 · Ruota dentata Z 20 · Kuggjul Z 20 Art.-Nr. 4 31021 1		●	●	●
 Bauplatte 30 x 90 · Building plate 30 x 90 · Panneau de revêtement à tenons 30 x 90 · Bouwplaat 30 x 90 · Panel de construcción 30 x 90 · Pannello di rivestimento 30 x 90 · Byggnadsplatta 30 x 90 – Art.-Nr. 4 38251 1	●	●	●		 Ritzel Z 10 mit Spannange · Cog wheel Z 10 with collet · Pignon Z 10 avec écrou de serrage · Rondsel Z 10 met spantang · Piñón Z 10 con pinza de apriete · Pignone Z 10 con pinza · Drev med klämtång – Art.-Nr. 3 31047 1			●	●
 Bauplatte 30 x 45 · Building plate 30 x 45 · Panneau de revêtement à tenons 30 x 45 · Bouwplaat 30 x 45 · Panel de construcción 30 x 45 · Pannello di rivestimento 30 x 45 · Byggnadsplatta 30 x 45 – Art.-Nr. 4 38248 1	●	●	●		 Kegelzahnrad · Bevel gear wheel · Roue coniques · Kegeltandwiel · Rueda dentada · Ruota dentata conica · Konisk kuggjul Art.-Nr. 3 31051 1				●
 Bauplatte 30 x 30 · Building plate 30 x 30 · Panneau de revêtement à tenons 30 x 30 · Bouwplaat 30 x 30 · Panel de construcción 30 x 30 · Pannello di rivestimento 30 x 30 · Byggnadsplatta 30 x 30 – Art.-Nr. 4 38259 1	●		●		 Zahnstange 30 · Rack 30 · Crémaillère de 30 · Tandstang 30 · Cremallera 30 · Cremagliera 30 · Kuggstång 30 Art.-Nr. 4 31054 1				●
 Bauplatte 15 x 90 · Building plate 15 x 90 · Panneau de revêtement à tenons 15 x 90 · Bouwplaat 15 x 90 · Panel de construcción 15 x 90 · Pannello di rivestimento 15 x 90 · Byggnadsplatta 15 x 90 – Art.-Nr. 4 38245 1	●	●	●		 Zahnstange 60 · Rack 60 · Crémaillère de 60 · Tandstang 60 · Cremallera 60 · Cremagliera 60 · Kuggstång 60 Art.-Nr. 4 31053 1				●
 Bauplatte 15 x 45 · Building plate 15 x 45 · Panneau de revêtement à tenons 15 x 45 · Bouwplaat 15 x 45 · Panel de construcción 15 x 45 · Pannello di rivestimento 15 x 45 · Byggnadsplatta 15 x 45 – Art.-Nr. 4 38242 1	●	●	●		 Kurbel 60 · Crank 60 · Manivelle grise 60 · Kruk 60 · Manivela 60 · Manovella 60 · Vev 60 Art.-Nr. 4 38239 1		●		●
 Bauplatte 15 x 30 · Building plate 15 x 30 · Panneau de revêtement à tenons 15 x 30 · Bouwplaat 15 x 30 · Panel de construcción 15 x 30 · Pannello di rivestimento 15 x 30 · Byggnadsplatta 15 x 30 – Art.-Nr. 4 38241 1	●	●	●		 Handkurbel · Crank · Manivelle · Handkruk · Manivela · Manovella · Handvev Art.-Nr. 4 31026 1		●		●

Stückliste · Part List · Nomenclature · Onderdelenlijst	100	100/1	200	200/1	Lista de piezas · Lista dei pezzi · Detalj översikt	100	100/1	200	200/1
 Führerhaus Seitenteil links · Driver's cab, left side · Cabine camion (partie gauche) · Zijstuk van kabine, links · Cabina conductor izquierdo · Cabina camion, lato sinistro · Förarhytt sidodel, vänster Art.-Nr. 4 38435 1	●	●	●		 Verbindungsstück 45 · Connector 45 · Languette d'assemblage 45 · Verbindingsstuk 45 · Pieza de empalme 45 · Connettore 45 · Förbindingsstycke 45 Art.-Nr. 4 31330 1	●		●	
 Führerhaus Seitenteil rechts · Driver's cab, right side · Cabine camion (partie droite) · Zijstuk van kabine, rechts · Cabina conductor derecho · Cabina camion, lato destro · Förarhytt sidodel, höger Art.-Nr. 4 38436 1	●	●			 Verbindungsstück 30 · Connector 30 · Languette d'assemblage 30 · Verbindingsstuk 30 · Conector 30 · Connettore 30 · Förbindingsstycke 30 Art.-Nr. 4 31061 1	●	●	●	
 Führerhaus 45 · Driver's cab 45 · Cabine de 45 · Kabinedak 45 · Cabina de conductor 45 · Cabina 45 · Förarhytt 45 Art.-Nr. 4 38443 1	●		●		 Verbindungsstück 15 · Connector 15 · Languette d'assemblage 15 · Verbindingsstuk 15 · Conector 15 · Connettore 15 · Förbindingsstycke 15 Art.-Nr. 4 31060 1	●	●	●	●
 Schaufelseite, links · Bucket, left side · Pelle partie gauche · Deel, laadschop, links · Paleta izquierda · Lato pala, sinistra · Skovelsida, vänster Art.-Nr. 4 37354 1	●		●		 Schaufelhalter · Blade holder · Support de pelle · Schuifbladhouder · Porta-paletas · Supporto per pala · Skovelhållare Art.-Nr. 4 38411 1	●	●	●	
 Schaufelseite, rechts · Bucket, right side · Pelle partie droite · Deel, laadschop, rechts · Paleta derecha · Lato pala, destra · Skovelsida, höger Art.-Nr. 4 37353 1	●		●		 Antriebsfeder 270 · Drive spring 270 · Ressort de transmission 270 · Aandrijfveer 270 · Resorte de transmisión 270 · Molla di trasmissione 270 · Drivandefjäder 270 Art.-Nr. 4 31028 7	●		●	
 Schaufelzwischenenteil · Bucketintermediate section · Pelle (partie centrale) · Tussenstuk laadschop · Paleta parte central · Elemento centrale pala · Skovelsida Art.-Nr. 4 37355 1	●		●		 Klemmbuchse 10 · Spring clip 10 · Bague de serrage 10 · Klembus 10 · Casquillo de apriete 10 · Bussola di serraggio 10 · Klämbussning 10 Art.-Nr. 3 31023 1	●	●	●	●
 Flügelachse 4x75 · Winged axle 4x75 · Axe gris verrouillable de 4x75 · Nokas 4x75 · Eje enclavable 4x75 · Asse bloccabile 4x75 · Vingaxel 4x75 Art.-Nr. 4 38257 1	●		●		 Klemmbuchse 5 · Spring clip 5 · Bague de serrage 5 · Klembus 5 · Anillo de apriete 5 · Bussola di serraggio 5 · Klämbussning 5 Art.-Nr. 3 37679 1	●	●	●	●
 Flügelachse 4x45 · Winged axle 4x45 · Axe gris verrouillable 4x45 · Nokas 4x45 · Eje enclavable 4x45 · Asse bloccabile 4x45 · Vingaxel 4x45 Art.-Nr. 4 38256 1	●		●		 Klemmkupplung · Coupling · Manchon d'accouplement · Klemmkoppeling · Manguito de acoplamiento · Manicotto d'accoppiamento · Klämkoppling Art.-Nr. 4 31024 1	●	●	●	●
 Zahnpurstanze · Toothed tie bar · Barre de direction à crémaillère · Heugel · Barra de dirección de cremallera · Tirante trasversale a cremagliera · Tandspärstäng Art.-Nr. 4 38472 1	●		●		 Kardangeln · Universal joint · Cardan · Cardanverbindung · Articulación cardán · Giunto cardanico · Kardanöverföring Art.-Nr. 3 31044 1				●
 Lenkhebel · Control link · Barre de direction · Stuurhefboom · Barra de dirección · Leva del fuso per sterzo · Styarm Art.-Nr. 4 38473 1	●		●		 Nockenscheibe · Disc-Cam · Came · Segmentschijf · Disco de levas · Camma · Kamskiva Art.-Nr. 4 31038 1				●
 Lenkbalken · Link beam · Train avant · Stuurbalk · Viga de unión · Avantreno · Styrbalk Art.-Nr. 4 38418 1	●		●		 Radstift · Half axle · Axe de roue à 1 tenon · Wielas · Eje de rueda · Semiassie · Hjulstift Art.-Nr. 4 38471 1	●		●	
 Achse mit 4-Kantansatz · Axle with square end · Axe plastique · As met 4-Kantnok · Eje con extremo cuadrado · Asse a testa quadra · Axel med 4-kantskarv Art.-Nr. 4 38412 1	●		●		 Strebe 120 · Strut 120 · Entretoise de 120 · Spant 120 · Montante 120 · Barra 120 · Stråva 120 Art.-Nr. 4 38532 1	●		●	
 Lagerbock · Coupling bracket · Appui de treuil · Steunstuk · Caballete de soporte · Supporto di cuscinetto · Hållare Art.-Nr. 4 38252 1	●		●		 Strebe 90 · Strut 90 · Entretoise de 90 · Spant 90 · Montante 90 · Barra 90 · Stråva 90 Art.-Nr. 4 38533 1	●		●	
 Kupplungsstück 30 · Coupling 30 · Élément d'attelage 30 · Koppelstuk 30 · Elemento de acoplamiento 30 · Giunto 30 · Kopplingselement 30 Art.-Nr. 4 38260 1	●		●		 Strebe 60 · Strut 60 · Entretoise de 60 · Spant 60 · Montante 60 · Barra 60 · Stråva 60 Art.-Nr. 4 38535 1				●
 Kupplungsstück 2 · Coupling 2 · Élément d'attelage 2 · Koppelstuk 2 · Elemento de acoplamiento 2 · Giunto 2 · Kopplingselement 2 Art.-Nr. 4 38253 1	●		●		 Strebe 45 · Strut 45 · Entretoise de 45 · Spant 45 · Montante 45 · Barra 45 · Stråva 45 Art.-Nr. 4 38536 1				●
 Kupplungsstück 1 · Coupling 1 · Élément d'attelage 1 · Koppelstuk 1 · Elemento de acoplamiento 1 · Giunto 1 · Kopplingselement 1 Art.-Nr. 4 38254 1	●		●		 Strebe 30 · Strut 30 · Entretoise de 30 · Spant 30 · Montante 30 · Barra 30 · Stråva 30 Art.-Nr. 4 38537 1			●	●
 Rollenlager · Roller bearing · Support de poulie · Rollager · Soporte de polea · Supporto per puleggia · Rullager Art.-Nr. 4 37636 1	●	●	●		 S-Riegel 8 · Triple rivet 8 · Rivet de 8 · S-Grendel 8 · Roblón 8 · Rivetto 8 · S-Regel 8 Art.-Nr. 4 36457 1				●
 Seilrolle ø 21 · Wheel pulley ø 21 · Poulie ø 21 · Snaarschijf ø 21 · Polea ø 21 · Puleggia ø 21 · Lintrumma ø 21 Art.-Nr. 4 35795 1	●	●	●		 S-Riegel 6 · Double rivet 6 · Rivet de 6 · Grendel 6 · Roblón 6 · Rivetto 6 · S-Regel 6 Art.-Nr. 4 36324 1	●		●	
 Seilrolle ø 12 · Wheel pulley ø 12 · Poulie ø 12 · Snaarschijf ø 12 · Polea ø 12 · Puleggia ø 12 · Lintrumma ø 12 Art.-Nr. 4 38255 1	●		●		 S-Riegel 4 · Single rivet 4 · Rivet de 4 · Grendel 4 · Roblón 4 · Rivetto 4 · S-Regel 4 Art.-Nr. 4 36323 1	●		●	
 Haken · Hook · Crochet · Haak · Gancho · Gancio · Linkrok Art.-Nr. 4 38225 1	●		●		 Verschlussriegel · Locking pin · Rivet de sécurité · Afsluitgrendel · Pasador de bloqueo · Chiavistello di chiusura · Regel Art.-Nr. 4 37232 1			●	●
 Seilklemmstift 4x15 · Cord clamp 4x15 · Segment de blocage 4x15 · Draadklem 4x15 · Segmento de bloqueo 4x15 · Perno di bloccaggio 4x15 · Stift til kabelklamma 4x15 Art.-Nr. 4 38226 1	●		●		 Riegelscheibe · Locking washer · Disque d'arrêt · Grendelschijf · Arandela de retención · Disco di blocco · Regelskiva Art.-Nr. 4 36334 1	●	●	●	●
 Nylonseil · Nylon line · Filin Nylon · Nylon draad · Hilo de nilón · Filo in nailon · Nylonrep Art.-Nr. 3 31027 1	●		●		 Kettenglied · Chain link · Chaînon · Schakel · Eslabones de cadena · Maglia di catena · Kättningslänk Art.-Nr. 4 36263 1			●	●
 Seiltrommel · Winch drum · Tambour · Kabel trommel · Tambor para cable · Tamburo · Lintrumma Art.-Nr. 4 31016 1	●		●		 Förderglied · Conveyor link · Chaînon à tenons · Schalm · Elementos de transporte · Maglie trasportatore a catena · Transportlänk Art.-Nr. 4 37192 1				●
 Klemmring für Seiltrommel · Locking ring for winch drum · Flasque de serrage pour tambour · Klemring voor kabeltrommel · Anillo de apriete para tambor de cabrestante · Anello di blocco per tamburo · Stopping till lintrumma – Art.-Nr. 4 31020 1	●		●		 Raupenbelag · Crawler track · Patin pour chenille · Rupsbandenbeslag · Forro para oruga · Rivestimento per cingolo · Kättingled Art.-Nr. 4 37210 1				●

 **fischertechnik-
Bau-Spiel-Bahn**

Güterzug und Personenzug in zwei großen Startpackungen. Komplett mit Schienen und fischertechnik-mini-Motor. Mit großem Zusatzprogramm. Ab 6 Jahre.

 **fischertechnik con-
struction model railway**

Goods train and passenger train complete with rails and fischer-technik mini motor in two large starter packs. Wide choice of supplementary kits. From 6 years.

 **Ferrocarril de juego
fischertechnik**

Tren de mercancías y tren correo en dos grandes paquetes iniciales. Completo con railes y mini-motor fischertechnik. Con gran programa de paquetes adicionales. A partir de 6 años.

 **Train à assembler
fischertechnik**

Train de marchandises et train de voyageurs dans deux grandes boîtes de base. Avec rails et mini-moteur fischertechnik. Vaste programme complémentaire. A partir de 6 ans.

 **Ferrovìa fischer-
technik da costruire**

Treno trasporto merci e treno viaggiatori in due grandi cassette di partenza. Completi di binari e di fischertechnik minimot. Con ampio programma addizionale. Da 6 anni in poi.

 **fischertechnik
bouw-speel-trein**

Goederentrein en personentrein in twee grote startpakketten. Kompleet met rails en de mini-motor van fischertechnik. Met het grote aanvullingsprogramma. Voor 6 jaar en ouder.

 **fischertechnik
Bygg-Lek-Tåg.**

Godståg och persontåg i två stora grundförpackningar. Komplett med skenor och fischertechnik mini-motor. Med stort tillbehörsprogram. Från 6 år.

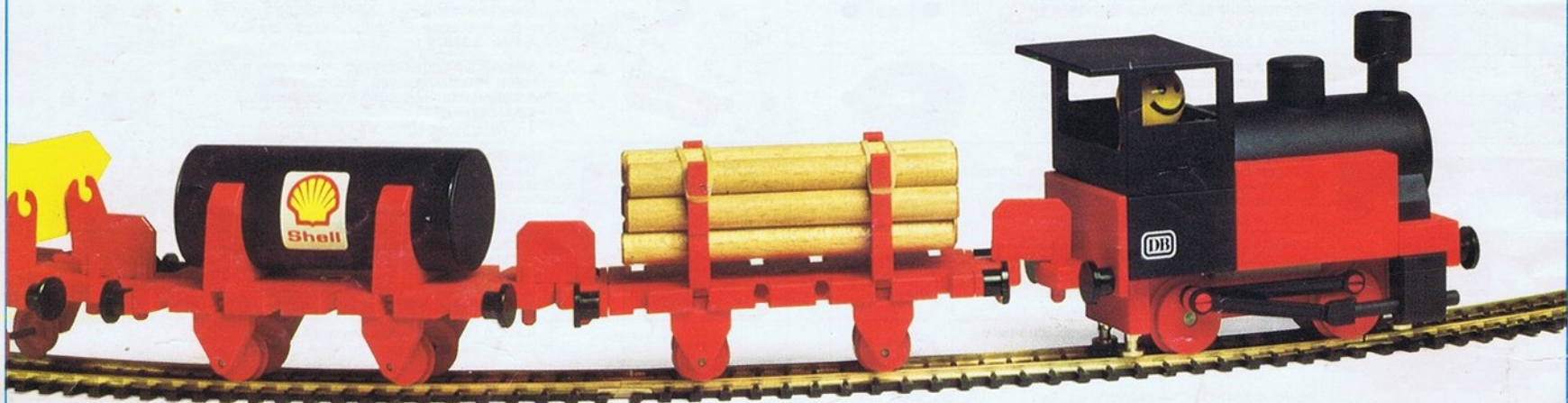

 **Drei große fischer-
technik-Modell-Bausätze**

Traktor mit Anhänger, Planier-
raupe, Karussell. Alle Modelle
schnell und leicht zu bauen.
Ab 6 Jahre.

 **Three big
fischertechnik model
building sets**

Tractor and trailer, bulldozer,
roundabout. All models can be
built easily and quickly.
From 6 years.

 **Tres grandes
cajas para modelos
fischertechnik**

Tractor con remolque, planeador-
oruga, carrusel. Todos modelos
pueden construirse rápido y
facilmente.
A partir de 6 años.

 **Trois grandes boîtes
de construction de
modèles fischertechnik**

Tracteur avec remorque, nivel-
leuse, manège. Le montage de
ces modèles est rapide et facile.
A partir de 6 ans.

 **Scatole contenenti
i pezzi per costruire tre
tre grandi modelli
fischertechnik**

Trattore con rimorchio, ruspa,
giostra. La costruzione dei
modelli è rapida e semplice.
Da 6 anni in poi.

 **Drie grote
modelbouwdozen van
fischertechnik**

Traktor met aanhanger, bull-
dozer, draaimolen. Alle modellen
kunnen vlug en gemakkelijk in
elkaar gezet worden.
Voor 6 jaar en ouder.

 **Tre stora
fischertechnik
modellbyggsatser**

Traktor med släpvagn, schakt-
maskin, karusell. Alla modellerna
bygges snabbt och lätt.
Från 6 år.

