



Building Blocks For Life



**fischertechnik** 

Learn about technology while playing.

2006



»If you're looking for innovation, you will find fischer.« The fischertechnik and fischer TiP products are dedicated to the same high standards as those for the fischer Group.

The fischer Group encompasses four divisions: fischer fixing systems with fixing technology and construction accessories, fischer automotive systems with such items as cup holders, ashtrays and multifunctional components for the automobile interior, fischertechnik with educational construction toys and play material as well as

fischer process consulting. Both toy brands, fischertechnik and fischer TiP, promote creativity and learning from playing. fischertechnik playfully reveals the world of technology to children and those who have remained young. With the fischer TiP make-it-yourself material, pre-school children can implement their own ideas by making things and models and painting.

You can find more information at: <http://www.fischer.de>



## World of fischer

Befestigungssysteme  
Automotive Systems  
Prozessberatung  
fischertechnik

**fischer** <sup>®</sup>  
UNTERNEHMENSGRUPPE



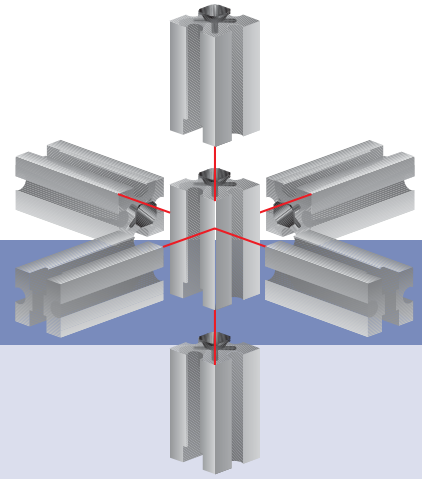

## Building Blocks For Life

### The fischertechnik basic building block can be built onto on all six sides.

This »many-sided« building block forms the basis for all fischertechnik construction sets, which are put together individually according to the age and capabilities of the children. These sets create a very real, but playful world of technology.

Entry into the four different product lines is possible at any time. All of this taken together forms a logical concept where one fits with the other.

Building block for building block. It doesn't matter how demanding the models become because you can always return to the components from other fischertechnik sets. To help you with the construction and discovery of the fascinating fischertechnik world, there is a comprehensive and easy to understand set of assembly instructions.

For all of those who want to know more, there are the instructional activity booklets in the Profi and computing construction sets with lots of background information, tasks and solutions or you can just browse through them.

Dear Business Partner,

fischertechnik has been inspiring technology fans worldwide, both the young and those who have remained young, for over 40 years. Today, if dads want to update their old favorite toy with the newest technology, they will soon find that fischertechnik has long ago established a liaison with the current high tech. Sensor technology, infrared control and the programming of fischertechnik robots with the PC have been the standard for quite some time. Also, the building blocks of today still fit with the building blocks of yesteryear.

fischertechnik lives from this successful mixture of tradition and innovation and also quite certainly from the capability to experience the reality of technology through play. Within this experience, extensive and easily understandable assembly instructions and didactic activity booklets support the construction of this reality.

We have also created great new products for you again this year. In addition, to the two new BASIC construction sets and our new products, »automobile« and »super cranes,« we have rounded out our computing line with the beginner construction set, »ROBO Starter Set.«

We are looking forward to continued outstanding cooperation and would like to thank you in this way for your valuable tips and suggestions.

Your fischertechnik Team



**JUNIOR**  
from age 5  
page 8

**BASIC +  
ADVANCED**  
from age 7  
page 9

**PROFI**  
from age 9  
page 14

**COMPUTING**  
from age 10  
page 16

## This is the way it works: Four lines and one idea.

### **JUNIOR**

The fun of playing starts at the age of five with fischertechnik. The red junior line provides the first experience with technology and the way it functions. The motto is learning by playing and building with fast success.

### **BASIC + ADVANCED**

Seven-year olds develop their knowledge and capabilities with the blue line. The models are not only realistic and understandable in their function, but really robust in construction and for playing.

### **PROFI**

The black line, which starts at nine years of age, offers the technicians of tomorrow design construction sets that are very close to reality. Subjects such as mechanics, statics, pneumatics, electrical technology or regenerative energies guarantee outstanding experiences in the world of technology.

### **COMPUTING**

If you love your computer, give it fischertechnik. With easy-to-use graphic software, children starting at 10 years old can program and control fischertechnik models and robots from their computer. It doesn't take long to get the feeling of success.



Everything that makes fischertechnik more attractive: fischertechnik-**PLUS** creates light, movement and more fun while playing.

### **PLUS**

For optimal supplementation see page 13

For fischertechnik, the one-time construction and collection of the models is not important, on the contrary, it is the repeated searching and discovery, the independent and creative

development of the person's own ideas and imagination and the art of being able to turn these into reality.

## The SMALL difference

### **DIDACTIC MATERIAL**

How does a gear box work? What is a planetary gear? How is the movement of a windshield wiper produced? How do you design a stable bridge? These questions are answered in the didactic activity booklets in the PROFI and COMPUTING construction sets with illustrations and easy-to-understand information.



*Assembly instructions*

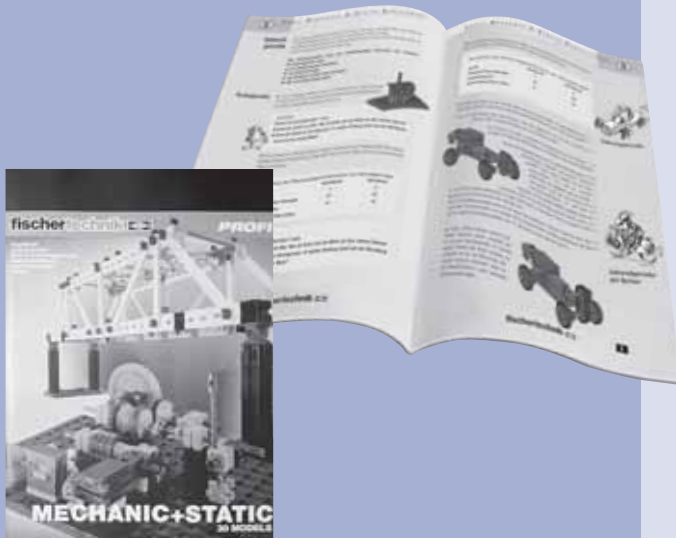

*Accompanying manual*

### **SYSTEMATIC STORAGE**

Every fischertechnik building block has its place in the very practical and well-designed storage system, which is available as a separate item.



*The sorting boxes in the construction sets create order.*



*Box 500  
Item No.: 94 828*



*Base Plate  
258x186 mm  
Item No.: 32 985*

*Box 1000  
Item No.: 30 383*



# NEW PRODUCTS

Spring 2006

## ROBO STARTER SET

The inexpensive entry into the world of robots. Professional models with a high degree of complexity impressively illustrate the possibilities and the capabilities of the fischertechnik computing series.

Includes interface, »ROBO I/O extension«, and the software, ROBO Pro, so that you can start right away. The eight different models deal with robot technology, mechatronics and everyday technology, of course always computer-controlled.



## CABLE CARS

The new BASIC construction set, Cable Car, has a very unusual and attractive subject. How does a cable car, a mountain railway or a freight elevator work? There is only one answer to all of these questions: fischertechnik



## BULLDOZER

The BASIC construction set ideally supplements the diverse themes in the BASIC line. Four different bulldozer models with crane function or cable winch provide the ideal entry into the world of tracked vehicles.





## Fall 2006

### AUTOMOBILE

A new and an even more exciting design has been included in the current theme construction sets in the ADVANCED series: The basic building block is red and the lines for the models are more modern and fresher. »Automobile« presents four different vehicle types: buggy, off-roader, roadster and truck.

Width: 102 cm



### SUPER CRANES

One superlative follows the other: Models with a height of over one meter, which can also lift heavy loads. Over 750 components produce impressive crane models. The new construction set, »Super Cranes,« is a sparkling bundle of functionality and reality. A traveling carriage, which can be displaced along the entire length of the crane boom, works like the original and allows near-real experience while playing. This construction set offers three models: the tower crane, port crane and the construction crane.



Height: 101 cm



# JUNIOR

from age 5

Kids can celebrate their first building success with the junior building sets. Even the youngest can construct models quickly as they play. Using the easy-to-understand assembly instructions and just a few turns

of your hands, you can build trucks, transports and cranes and so forth. So playing is not neglected. Concentration and motor skills are playfully developed with the handy components and the many possible variations.

## It's not small at all



**ASSEMBLY INSTRUCTIONS**  
In each construction set you will find a detailed and easily understandable set of assembly instructions!



### STARTER

Item No. 30 323  
EAN 4006209303238

The beginner construction set  
• 50 components and 4 models

	Dimension (mm)	Vol (m <sup>3</sup> )	Weight	PU
Kit	280x65x180	0,0033	350 g	
Carton	298x203x218	0,0132	1,26 kg	3 pcs.



### JUMBO PACK

Item No. 16 551  
EAN 4006209165515

14 models and of these four can be built at the same time. For play groups or friends!  
• 135 components and 14 models

	Dimension (mm)	Vol (m <sup>3</sup> )	Weight	PU
Kit	465x80x320	0,0119	1100 g	
Carton	487x281x342	0,0468	4,04 kg	3 pcs.



# BASIC

from age 7

The basic building sets create a lot of fun for building and playing for little money. Bulldozers, helicopters or tractors: the broad diversity of the everyday technology is amazingly simple, but so

realistic. The construction set, "Vehicles," for example, offers an in-depth view of the functioning of vehicles and their mechanisms.

## The Basics



### TRACTORS

Item No. 96 779  
EAN 4006209967799

- 75 components and 3 models

	Dimension (mm)	Vol (m <sup>3</sup> )	Weight	PU
Kit	280x65x180	0,0033	650 g	
Carton	298x203x218	0,0132	2,16 kg	3 pcs.



### AIRCRAFT

Item No. 96 776  
EAN 4006209967768

- 100 components and 3 models

	Dimension (mm)	Vol (m <sup>3</sup> )	Weight	PU
Kit	280x65x180	0,0033	600 g	
Carton	298x203x218	0,0132	2,01 kg	3 pcs.



### FUN CARS

Item No. 96 777  
EAN 4006209967775

- 85 components and 3 models

	Dimension (mm)	Vol (m <sup>3</sup> )	Weight	PU
Kit	280x65x180	0,0033	400 g	
Carton	298x203x218	0,0132	1,41 kg	3 pcs.



### CRANES

Item No. 96 778  
EAN 4006209967782

- 100 components and 3 models

	Dimension (mm)	Vol (m <sup>3</sup> )	Weight	PU
Kit	280x65x180	0,0033	400 g	
Carton	298x203x218	0,0132	1,41 kg	3 pcs.



### BULLDOZER

Item No. 41 858, available spring 2006  
EAN 4006209418581

Crawler crane, bulldozer, tracked recovery vehicle and a snow cat, four different tracked vehicles provide play and fun.

- About 240 components and 4 models

	Dimension (mm)	Vol (m <sup>3</sup> )	Weight	PU
Kit	330x85x235	0,0066	600 g	
Carton	343x273x248	0,0232	2,72 kg	4 pcs.



### CABLE CARS

Item No.: 41 859, available spring 2006  
EAN 4006209418598

Glide down the slope on a 5-meter long cable with the gondola clear up at the top and then with the freight elevator clear down at the bottom. Have fun.

- About 120 components and 3 models

	Dimension (mm)	Vol (m <sup>3</sup> )	Weight	PU
Kit	330x85x235	0,0066	600 g	
Carton	343x273x248	0,0232	2,72 kg	4 pcs.



### RACING

Item No. 96 780  
EAN 4006209967805

Blaze through the room. Pit stop, put on new tires, fill up and off you go.

Four Formula 1 racers and one can build the gas station and car jack at the same time.

- 125 components and 5 models

	Dimension (mm)	Vol (m <sup>3</sup> )	Weight	PU
Kit	330x85x235	0,0066	650 g	
Carton	343x273x248	0,0232	2,92 kg	4 pcs.



### VEHICLES

Item No. 57 483  
EAN 4006209574836

Road roller, snow plow or tank wagon. All models with steering, the forklift with movable fork.

- 130 components and 4 models

	Dimension (mm)	Vol (m <sup>3</sup> )	Weight	PU
Kit	330x85x235	0,0066	650 g	
Carton	343x273x248	0,0232	2,92 kg	4 pcs.

# ADVANCED

from age 7

Now we are really going to get moving: For the advanced in the fischertechnik group of technicians! The function is understandable with lots of details such as four-wheel steering and track chains that crawl over the terrain. Cranes that lift heavy loads. Merry-go-rounds that make the figures fly and really

robust in construction and for playing. With genuine functions and lots of attachment and expansion possibilities. Detailed assembly instructions lead to the finished models in logical steps.

## Unbelievable

## with so ...



### UNIVERSAL II

Item No. 93 290  
EAN 4006209932902

The universal genius with bench vise, lifting platform with car, sewing machine and an entire amusement park.

Several models can be built at the same time. Here, the everyday technology is understood and experienced.

- 400 components and 48 models
- Ideal additions are: mini-motor, power motor and energy set, page 13.

	Dimension (mm)	Vol (m <sup>3</sup> )	Weight	PU
Kit	465x80x320	0,0119	1750 g	
Carton	487x281x342	0,0468	5,99 kg	3 pcs.



### CLASSIC

Item No. 96 781  
EAN 4006209967812

The "classic" introduction to the world of technology with a road roller, vehicles with steering, merry-go-round, swing, fan, construction crane and water wheel and so forth. For all kids that want to build things in a special creative way.

- 115 components and 16 models
- Ideal addition is the mini-motor on page 13

	Dimension (mm)	Vol (m <sup>3</sup> )	Weight	PU
Kit	465x65x320	0,097	900 g	
Carton	487x281x342	0,0468	4,34 kg	4 pcs.





### AUTOMOBILE

Item No.: 41 860, available fall 2006  
 EAN 4006209418604

Three trucks with dump function, lowerable container or tow truck with car platform. In addition, a hot roadster, a robust off-roader and a cool buggy.

- About 350 components and 8 models
- Ideal additions are: mini-motor and power motor Battery set and IR control set on page 13

	Dimension (mm)	Vol (m <sup>3</sup> )	Weight	PU
Kit	465x80x320	0,0119	1100 g	
Carton	487x281x342	0,0468	3,94 kg	3 pcs.



### POWER TRACTORS

Item No. 91 079  
 EAN 4006209910795

Get started on the tractor models or the big MB trac with the strong profile tires: Double-axle trailer, big hay wagon or trailer with steering. Now, at harvest time, you can choose from a potato harvester, hay turner and tongs or a plow.

- 550 components and 12 models
- Ideal additions are: mini-motor and power motor Battery set and IR control set on page 13

	Dimension (mm)	Vol (m <sup>3</sup> )	Weight	PU
Kit	465x80x320	0,0119	1800 g	
Carton	487x281x342	0,0468	6,14 kg	3 pcs.



### POWER BULLDOZER

Item No. 16 552  
 EAN 4006209165522

Powerful tracked vehicles on a big expedition. A snow cat, bulldozer with adjustable dozer blade, a tracked recovery vehicle with cable winch and towing hook. For everybody that loves adventure.

- 700 components and 4 models
- Ideal additions are: mini-motor and power motor Battery set and IR control set on page 13

	Dimension (mm)	Vol (m <sup>3</sup> )	Weight	PU
Kit	465x80x320	0,0119	1450 g	
Carton	487x281x342	0,0468	5,09 kg	3 pcs.



# ADVANCED

from age 7

This line is a real challenge for real hobby inventors. With up to 900 parts and diverse functions, these constructions sets such as Super Trucks, Super Cranes and Fun Park do justice to their names.

## From the experiment, to the discoverer and pride in invention



### SUPER TRUCKS

Item No.: 41 862, available fall 2006

EAN 4006209418628

Caution: Giants at work! More than one meter high and the boom is over a meter long, turns at the top or bottom and is built for really big loads! With traveling carriage and lifting tackle, mobile or stationary.

- About 750 components and 3 models
- Ideal additions are: Power motor, lights and energy set, page 13.

	Dimension (mm)	Vol (m <sup>3</sup> )	Weight	PU
Kit	465x100x390	0,0181	2400 g	
Carton	569x336x429	0,0820	7,88 kg	3 pcs.



### SUPER TRUCKS

Item No. 77 790

EAN 4006209777909

Six different heavy duty trucks hit the road! The low-bed trailer for really heavy equipment such as the big »power bulldozer,« long-timber trucks with steerable trailers, the heavy-duty crane with double-axle steering and extendable supports or the tractor truck with unhookable trailer and powerful semi-trailer tractor. For small freight forwarders.

- 800 components and 6 models
- Ideal additions are: mini-motor and power motor Battery set and IR control set on page 13

	Dimension (mm)	Vol (m <sup>3</sup> )	Weight	PU
Kit	465x100x390	0,0181	3000 g	
Carton	569x336x429	0,0820	9,68 kg	3 pcs.



### FUN PARK

Item No. 57 484

EAN 4006209574843

The ferris wheel has a grand height of 70 cm. The chain merry-go-round has a diameter of almost 50 cm. The ingenious functions of the octopus with two counter-rotating eccentric rotational movements for rotation and up and down creates a real carnival atmosphere.

- 900 components and 3 models
- Ideal additions are: Power motor, lights and energy set, page 13.

	Dimension (mm)	Vol (m <sup>3</sup> )	Weight	PU
Kit	465x100x390	0,0181	3100 g	
Carton	569x336x429	0,0820	9,98 kg	3 pcs.



# PLUS

Everything that makes fischertechnik more attractive. The fischertechnik supplemental sets create light, movement and additional fun for every model.

## Supplemental Sets



### CREATIVE BOX 1000

Item No. 91 082  
EAN 4006209910825

More than 700 components from the current fischertechnik assortment.

Packed in BOX 1000 with building board, 390 x 270 mm, as cover.

- 600 components and 8 sorting boxes

	Dimension (mm)	Vol (m <sup>3</sup> )	Weight	PU
Kit	395x100x275	0,0109	2900 g	
Carton	415x215x290	0,0259	6,25 kg	2 pcs.



### BOX 1000

Item No. 30 383  
EAN 4006209303832

Practical storage box with eight sorting boxes and 32 sorting partitions. The cover also serves as a big building board, 390 x 270 mm.

- 8 sorting boxes
- Big building board

	Dimension (mm)	Vol (m <sup>3</sup> )	Weight	PU
Kit	395x100x275	0,0109	1800 g	
Carton	415x215x290	0,0259	4,05 kg	2 pcs.



### POWER MOTOR SET

Item No. 34 965  
EAN 4006209349656

The powerful gear unit motor with toothed wheels, worm gear, differential, pole-reversing switch, cable and plug.

- Performance data: Voltage 9V  $\pm$ , max. output 2.4 W at 340 RPM, gear reduction 8:1.
- 35 components,
- Additionally required is the energy set or a battery set

	Dimension (mm)	Vol (m <sup>3</sup> )	Weight	PU
Kit	225x65x150	0,0022	300 g	
Carton	253x166x218	0,0092	1,07 kg	3 pcs.



### MINI MOTOR SET

Item No. 30 342  
EAN 4006209303429

The universal motor set with S motor, 9 V battery holder and many gear unit parts: gear wheels, angular gear, differential and universal joint etc.

- Performance data: Voltage 9V  $\pm$ , Max. output 1.1 W at 5000 RPM
- 50 components

	Dimension (mm)	Vol (m <sup>3</sup> )	Weight	PU
Kit	225x65x150	0,0022	350 g	
Carton	253x166x218	0,0092	1,22 kg	3 pcs.



### ENERGY SET

Item No. 30 182  
EAN 4006209301821

The power supply from the electrical socket for all fischertechnik models.

- Output: 9V  $\pm$ , 1000 mA
- Power unit + control unit in one

	Dimension (mm)	Vol (m <sup>3</sup> )	Weight	PU
Kit	225x65x150	0,0022	650 g	
Carton	253x166x218	0,0092	2,12 kg	3 pcs.



### ACCU SET

Item No. 34 969  
EAN 4006209349694

Mobile power supply: Battery pack, NiCad 8.4 V, 940 mAh and specially adjusted microcontroller charger, turbocharge, charging time about 1.8 hr.

- With  $\Delta U$  safety charging monitoring
- Charger + battery pack in one

	Dimension (mm)	Vol (m <sup>3</sup> )	Weight	PU
Kit	225x65x150	0,0022	850 g	
Carton	253x166x218	0,0092	2,72 kg	3 pcs.



### LIGHTS

Item No. 34 970  
EAN 4006209349700

The light set consists of four light bulbs, colored luminous caps, cable, plug and blink electronics for up to eight light bulbs. Short-circuit and overload proof. For blinking or continuous light. With 9 V battery holder.

- 35 components

	Dimension (mm)	Vol (m <sup>3</sup> )	Weight	PU
Kit	225x65x150	0,0022	150 g	
Carton	253x166x218	0,0092	0,62 kg	3 pcs.



### IR CONTROL SET

Item No. 30 344  
EAN 4006209303443

Ten meter range three independent motor outputs, two can be controlled at the same time, two speed levels. Transmitter can activate up six motors with IR receiver II.

- Transmitter + IR receiver I
- Required for the transmitter: 2 batteries LR03, 1.5 V AAA
- For the receiver: energy set or a battery set.

	Dimension (mm)	Vol (m <sup>3</sup> )	Weight	PU
Kit	225x65x150	0,0022	250 g	
Carton	253x166x218	0,0092	0,92 kg	3 pcs.

# PROFI

from age 9

Jump into the car, put it in gear and get going. But how does the technology work that allows us to use a low gear to go, slowly, but easily up a mountain or to fly down the mountain in a high gear?

How does a kitchen appliance or a planetary gear work? Why don't bridges collapse and why does a wobbly table become stable with four cross struts. These and other questions are answered in detail in the Profi line.

## Really close ...



### PROFI MECHANIC+STATIC

Item No. 93 291  
EAN 4006209932919

The ultimate technology construction set for all future mechanical engineers, technicians and engineers: How does a gear box work? What is a planetary gear? How is the movement of a windshield wiper produced? How do you design a stable bridge?

The answers to these and other elementary questions from the subject areas of mechanics and statics are found in this construction set with 30 different models.

- Includes the instructional activity booklet, **Mechanics + Statics**
- Includes mini-motor, switch and battery holder
- 500 components and 30 models

	Dimension (mm)	Vol (m <sup>3</sup> )	Weight	PU
Kit	465x80x320	0,0119	2100 g	
Carton	487x199x342	0,0331	4,80 kg	2 pcs.



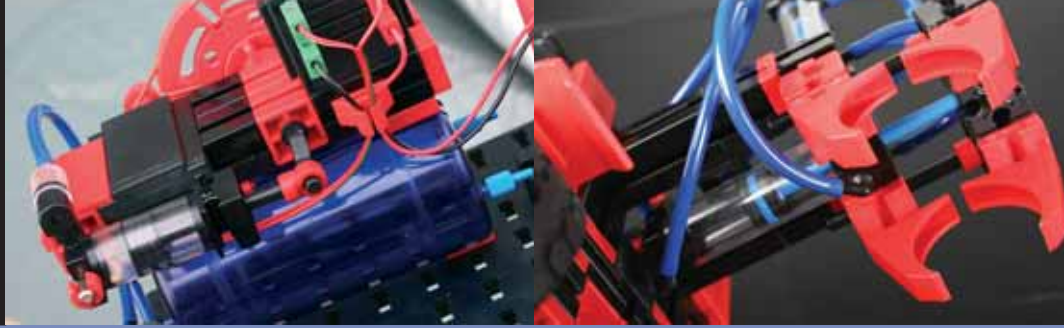

## ... Technology and Knowledge



### PROFI PNEUMATIC II

Item No. 77 791  
EAN 4006209777916

The Profi Pneumatics II provides playful learning of the basics of this "airy" technology and shows, using numerous application examples, the way that pneumatic valves and cylinders work in connection with a compressor and an air cell. It contains four double-acting pneumatic cylinders, three 4/3 way hand valves and one electrically operated compressor with air cell.

- Includes the instructional activity booklet, "Pneumatics: Create Movement with Compressed Air."
- Includes compressor with mini-motor, switch and battery holder.
- 400 components and 8 models

	Dimension (mm)	Vol (m <sup>3</sup> )	Weight	PU
Kit	465x80x320	0,0119	1920 g	
Carton	487x199x342	0,0331	4,44 kg	2 pcs.



**ÖKO-TEST**  
RICHTIG GUT LEBEN  
Solarbaukasten  
PROFI-Oeco-Power  
**SEHR GUT**  
Ausgabe 12/2001  
Rubrik: Weihnachtsgeschenke  
für das Kind

### PROFI OECO POWER

Item No. 57 485  
EAN 4006209574850

»Renewable energies« will become our most important suppliers of energy in the future. The production, storage and use of energy from natural energy sources such as water, wind and the sun is illustrated using the eight models and numerous experiments. This is the way to create an understanding of the future energy forms.

- Includes the instructional activity booklet, »Renewable Energies.«
- Includes solar motor, 2 solar cells and »Gold Cap« energy storage unit.
- 190 components and 8 models

	Dimension (mm)	Vol (m <sup>3</sup> )	Weight	PU
Kit	465x80x320	0,0119	1350 g	
Carton	487x199x342	0,0331	3,30 kg	2 pcs.

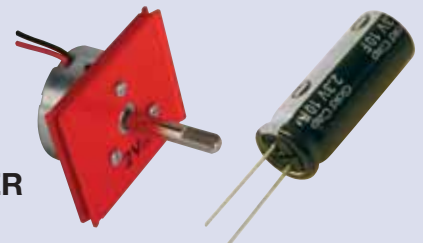

### PROFI E-TEC

Item No. 91 083  
EAN 4006209910832

Electrical switches, electromechanics and electronic controls. Using functional models, for example, the principle of series and parallel connections and the control of a traffic light are explained step by step. For this purpose, you have the e-tech module (see above) with eight set programs that control, for example, a burglar alarm with a buzzer, a hand dryer with a light barrier or a garage door with a magnetic sensor and these devices are through three inputs for digital sensors such as a probe, phototransistor and reed contact and an output for a motor or two light bulbs.

- Includes the instructional activity booklet, »Electrical Technology.«
- Includes mini-motor, e-tech module, sensor, light barrier, magnetic sensor and buzzer.
- 260 components and 12 models

	Dimension (mm)	Vol (m <sup>3</sup> )	Weight	PU
Kit	465x80x320	0,0119	1600 g	
Carton	487x199x342	0,0331	3,80 kg	2 pcs.



# COMPUTING

from age 10

Design machines and robot models, program the control software on the PC and put the entire thing in motion. What sounds so complicated and technical becomes a fascinating and creative game with computing and this doesn't apply only to technically enthusiastic kids. You need a commercially

available PC with a Windows operating system, Win 98 or later, the easy-to-use graphic fischertechnik software, ROBO Pro, to program the commands that the robot is to carry out. In addition, the "ROBO interface," which converts the computer commands into control signals for the motors.

## Program the robot yourself



8 models +  
»ROBO I/O Extension«  
as interface +  
software



8 mobile robots +  
»ROBO Interface« +  
software



### ROBO STARTER SET

Item No.: 41 863, available spring 2006  
EAN 40062093418635

The complete beginner package: 150 components for eight simple-to-build models such as a traffic light, barrier, heating control or hand dryer. The ROBO I/O extension as a passive interface to the PC, the software, ROBO Pro, and in addition the detailed programming book, which explains the graphic software in a simple and understandable manner.

- Includes the didactic activity booklet, »Programming and Control of fischertechnik Models with the PC.«
- Includes ROBO I/O extension as an interface for USB.
- Includes control software, ROBO Pro.
- Includes mini-motor, three sensors, one phototransistor and one NTC resistance for measuring temperatures and 3 light bulbs.
- About 150 components and 8 models
- Additionally required is energy set or IR control set on page 13.

	Dimension (mm)	Vol (m <sup>3</sup> )	Weight	PU
Kit	465x80x320	0,0119	2050 g	
Carton	487x199x342	0,0331	4,70 kg	2 pcs.

### ROBO MOBILE SET

Item No. 93 292  
EAN 4006209932926

The complete Profi package, which consists of 480 components for the building of eight mobile robot models, the programmable ROBO interface and the ROBO Pro software. The instructions explain the construction of the seven mobile robots with all-round edge recognition or obstacle recognition and the mobile robot with six legs. The robot with the light detector continually follows a moving light source and the model, "trail searcher," follows a black line. In addition, the light detector can be combined with obstacle recognition. The mobile robot moves like an insect and can move forwards, backwards and right and left.

- Includes the didactic activity booklet, "Programming and Control of fischertechnik Robots with the PC."
- Includes the ROBO interface.
- Includes control software, ROBO pro.
- Includes 2x power motor, 4 sensors, 2 phototransistors, 1 lens light bulb.
- 480 components and 8 models
- Also requires battery set on page 13.
- Ideal addition is ROBO RF data link on page 17.

	Dimension (mm)	Vol (m <sup>3</sup> )	Weight	PU
Kit	465x80x320	0,0119	2750 g	
Carton	487x199x342	0,0331	6,10 kg	2 pcs.

### INDUSTRY ROBOTS II

Item No. 96 782  
EAN 4006209967829

Three reality-based and fully functional industry robots with precise details: one triple-axis industry robot and two welding robots. In addition, a CD-ROM with corresponding examples programs.

- Includes the didactic activity booklet, »Programming and Control of fischertechnik Robots with the PC.«
- Includes power motor, 3x mini-motor, 8 sensors and ball plug-in light.
- 360 components and 3 models
- Additionally required is ROBO interface + ROBO Pro software on page 17. Energy set or IR battery set on page 13

	Dimension (mm)	Vol (m <sup>3</sup> )	Weight	PU
Kit	465x80x320	0,0119	1700 g	
Carton	487x199x342	0,0331	4,00 kg	2 pcs.





## ROBO INTERFACE

Item No. 93 293  
EAN 4006209932933

With 16 bit microcontroller, USB and serial interface, 128 kB flash memory for downloading 2 programs

- 4 adjustable motor outputs 9V/250mA
- 8 digital inputs
- 2 analog inputs for resistors 0-5 kΩ
- 2 analog inputs for voltage 0-10V
- 2 analog inputs for gap sensors
- one connection each for "ROBO I/O Extension" module and "ROBO RF Data Link" interface for "IR Control Set"
- Programmable with "ROBO Pro" or C-Compiler (not contained in scope of delivery).
- Also Required: Energy Set or Accu Set

	Dimension (mm)	Vol (m³)	Weight	PU
Kit	225x65x150	0,0022	500 g	
Carton	253x166x218	0,0092	1,67 kg	3 pcs.



## ROBO I/O-EXTENSION

Item No. 93 294  
EAN 4006209932940

Expansion module for ROBO interface. Connection using a 10-pin ribbon cable. USB interface for online operation directly on the PC. Connection for additional ROBO I/O extensions with up to three in a series.

- 4 adjustable motor outputs, 9 V, 250 mA
- 8 digital inputs
- 1 analog input for resistances of 0 to 5 kΩ
- Also requires energy set or battery set on page 13.

	Dimension (mm)	Vol (m³)	Weight	PU
Kit	225x65x150	0,0022	250 g	
Carton	253x166x218	0,0092	0,92 kg	3 pcs.



## ROBO PRO SOFTWARE

Item No. 93 296 (Windows 98, ME, NT, 2000, XP)  
EAN 4006209932964

Simple entry for beginners through programming of flow charts consisting of various software building blocks. The exchange of the data between the software building blocks and the subprograms can be done through variables and graphical connections as well. This allows the program functions to be shown in an understandable manner.

There are no problems with the preparation of teach-in programs or data exchange with other Windows software. In an online mode, several »ROBO interfaces« can be controlled parallel for big models.

	Dimension (mm)	Vol (m³)	Weight	PU
Kit	210x25x150	0,0008	100 g	
Carton	253x166x218	0,0092	0,47 kg	3 pcs.



## ROBO RF DATA LINK

Item No. 93 295  
EAN 4006209932957

Radio interface for the »ROBO interface«. Connection to the PC at the USB interface. Connection to the interface as an additional printed circuit board, which is plugged into the interface printed circuit board. Range is about 10 m. Eight adjustable frequencies for simultaneous operation of eight devices in one room. Direct communications between two »ROBO interfaces« with the same frequency is possible.

- Frequency: 2.4 GHz
- No additional power supply is needed.

	Dimension (mm)	Vol (m³)	Weight	PU
Kit	225x65x150	0,0022	350 g	
Carton	253x166x218	0,0092	1,22 kg	3 pcs.

# ASSORTMENT RECOMMENDATION

Perfectly developed placement plans, finely tuned to the sales performer and the important supplements support sales.

## Then it fits

Assortment B: 1.25 m x 2.0 m

This basic assortment contains a packaging unit of the top selling fischertechnik construction sets for placement on a shelf space with a width of 1.25 meters and a height of 2.0 meters.

Assortment A: 2.5 m x 2.0 m

This competent assortment contains a packaging unit of the relevant fischertechnik construction sets for specialized retail for placement on a shelf space with a width of 2.5 meters and a height of 2.0 meters.





# PROMOTION OF SALES

We support your sales with highly effective and attention-getting measures and aids so that you can achieve the optimal presentation at the point of sale (POS) and in the display window for the best-possible attraction of the end consumer.

## Optimal Support



► **End consumer flyer**  
DIN A5, Item No. 39 090



► **Hourly Schedule**  
20x15 cm, Item No. 112 022



► **shopping bag**  
46x59 cm, Item No. 112 023



► **Poster dozer motif**  
DIN A1, Item No. 39 125

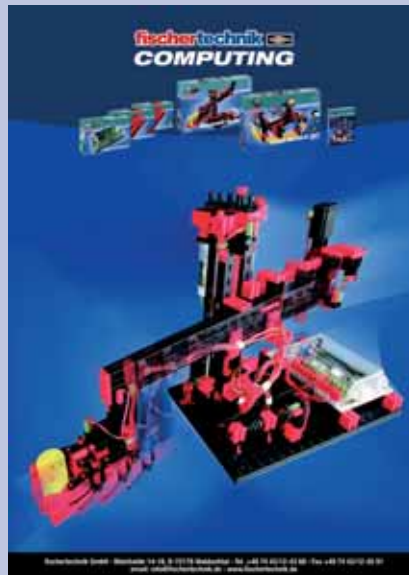

► **Poster computing motif**  
DIN A1, Item No. 39 126

► **Top signs**

► **Shelf hangers**

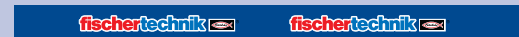

► **Shelf strips**  
in various lengths



► **Display window deco and demonstration models**  
(upon request)



► **informative and exciting sales video**  
(upon request)



► **The bulldozer race**  
(upon request)

The sensational event with pure excitement where everybody can participate! The person that finishes the fishertechnik course the fastest with the remote-controlled bulldozer model gets a great prize. The race can be conducted with little expenditure and the race course can be set up anywhere without a problem.

# MARKETING

Don't talk just act is our motto. We have developed a diversity of measures, which create a high interest based on the high degree of recognition of fischertechnik and provide more sales for you.

## We give a big push

### Baden-Württemberg

SPIELT



#### ► BADEN-WÜRTTEMBERG PLAYS

Ten days of games  
Ideal target group: families with children  
130,000 direct customer contacts



#### ► SPIELMITTEL

Advertisement in the parent's magazine, Spielmittel (german). Items on display for several months in over 5000 pediatricians' offices



#### ► DEALER TRAINING

We make you fit for providing competent advice to your customers.

#### ► KNOWN FOR OVER 40 YEARS

You can profit from the high degree of recognition of the fischertechnik brand.

#### ► YOUTH RESEARCH

Support throughout the year for regional fischertechnik youth research teams

jugend  forscht



#### ► PRIZE GAMES

Provision of numerous products for prize games. Cross promotions with fischer TiP and other areas in the fischer Group

#### ► USE IN SCHOOLS

Worldwide use in technology instruction from elementary school to the university.





► **CONSUMER TRADE FAIRS**

Participation in various trade fairs such as the Toy Trade Fair in Stuttgart and the Intermodel Construction in Dortmund etc.



► **DEUTSCHES MUSEUM**

Permanent exhibition in German Museum (Deutsches Museum) Munich



► **MUSEUM SINSHHEIM**

Permanent exhibit in the Technical Museum in Sinsheim



► **CHILDREN'S EVENTS**

Active participation in children's festivals and big events, for example, the Airport Children's Festival in Stuttgart.

► **COOPERATION MICROSOFT**



"fischertechnik is the proof that playing, the thirst for knowledge and education can be combined in a fascinating way." Dr. Ingo Dahm, Manager Academia, Microsoft Germany

► **FAN-CLUB**

Worldwide active fan club with over 30,000 members and its own fan club news



► **USE IN INDUSTRY**

Worldwide use in industry area for the simulation and visualization of technical processes



# SCHOOL

The instructional building sets from fischertechnik are specially designed for use in technical instruction and in technical facilities for the primary and secondary level. Here, there are the following topics: Mechanics, statics, electrical technology, regenerative energies and measuring,

controlling and regulating (information science, mechatronics and computing). This is supported by books, instructional activity booklets and worksheets. In addition, there are intelligent storage systems that provide order and reliability for the everyday things at school.

Additional information is available at: »<http://www.fischertechnik.de>«

## fischertechnik for Teaching



### DIDACTIC MATERIAL

How does a gear box work? What is a planetary gear? How is the movement of a windshield wiper produced? These are questions, which our instructional activity booklets illustrate and explain in a way that is easy to understand. This starts with elementary topics from the various subject areas such as mechanics, statics, electronics and information science etc. and progresses to the practical implementation, which can be understood quickly, of everyday technical devices such as traffic lights, fans and a lifting tackle and then moves on to the technically refined and demanding solutions for robotics and computing. Additional worksheets can be downloaded from the fischertechnik Web site and with the thematically developed questions and answers, these are an additional instrument to provide understanding of the corresponding instruction in a simple and precise manner and to test the learning success.

In addition, there is the very practical and well-designed storage system where each part has its place and is quickly found and helps with the daily didactic work (available separately).



**Assembly instructions**



**Activity booklet**



**Sorting box**  
Item. No.: 94 828

**Base Plate**  
258x186 mm  
Item. No.: 32 985



**Work Sheets**



# TRAINING MODELS

Compact function models, which are already assembled, provide ideal training and demonstration models for training and in-service training and industrial automation. Available in the 9 V standard voltage and in the worldwide 24 V industrial standard.

Additional information is available at: »<http://www.fischertechnik.de>«

## For training and in-service training



### 3-D-ROBOT

3-axis robot with tongs, 4 direct current motors  
4 limit switches  
4 pulse sensing devices for measuring distances  
All sensors are potential-free.



# PLAN+SIMULATION

The function models from fischertechnik, plan + simulation, are a proven and inexpensive means to plan and to develop industrial controls with the associated software

and to test processes. They are employed worldwide in the areas of training, development and presentation.

Additional information is available at: »<http://www.fischertechnik.de>«

The flexibility and the modularity of the fischertechnik system in connection with the industrially adapted sensors and actors as well as the controls from leading manufacturers open up almost unlimited possibilities for hardware simulation. Complicated technical systems are presented realistically and so perfectly simulated so that they are understandable for everyone. This makes investment decisions easier and reduces the costs for the correction of planning mistakes.

**The step  
into reality**

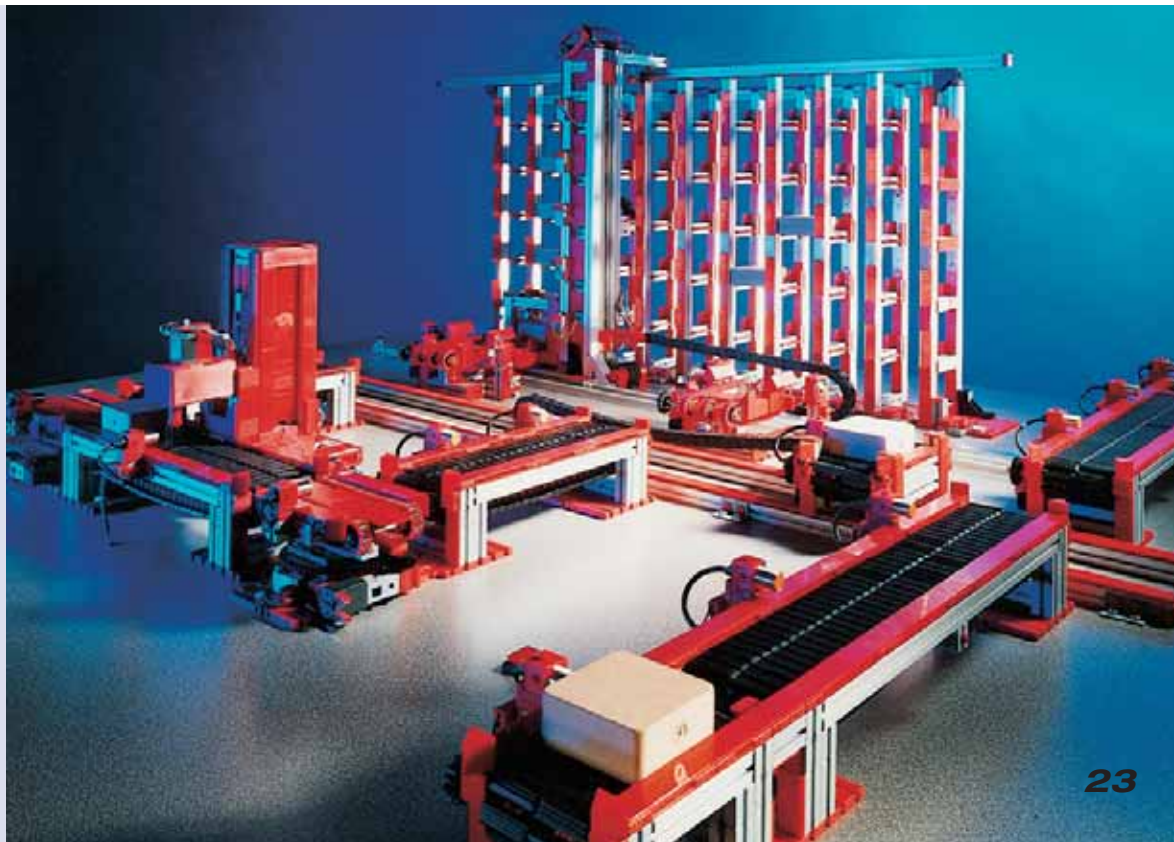

## In good hands



### WHAT DO YOU GET FROM THIS AS A TOY DEALER?

A uniform system with design construction sets at the highest level and the best quality as well as the strong fischertechnik brand as a reference for your pedagogical and valuable range of toy products. Over 30,000 fan club members, optimal support and a well-founded assortment system and diverse supplemental products serve to promote your sales throughout the year.

### WHAT DO PARENTS GET FROM THIS?

The certainty that their child can playfully enter the world of technology and understand and learn about it. The independent construction of continually new fischertechnik models promotes logical thinking and creativity. Thus, you are supporting the natural talent of your children to grasp technology in the truest sense of the word. The fischertechnik world of your children is boundless because all construction sets fit ideally together and supplement each other.

### WHAT DO CHILDREN GET FROM THIS?

Only the best: they can play and play and play. They use their creativity and concentration when building models and after this they can have fun with role playing with each other.

- A quality product made in Germany.
- High degree of acceptance by parents, teachers and engineers.
- All construction sets can be ideally combined with one another.
- Awarded with:

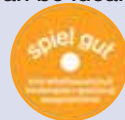

fischertechnik GmbH  
Weinhalde 14-18, D-72178 Waldachtal  
Phone +49 74 43/12-42 93, Fax +49 74 43/12-45 91  
E-mail: info@fischertechnik.de

**fischertechnik** 

The right is reserved to make errors and technical and assortment changes. Liability for printing errors and defects is excluded.

[www.fischertechnik.de](http://www.fischertechnik.de)