



Building Blocks For Life

fischertechnik 



Understand technology by playing.

2010

This is the way it works: **FOUR** productlines and **ONE** theme

The fischertechnik basic building block can be built on all six sides. This „many-sided“ building block forms the basis for all fischertechnik construction sets, which are put together according to age and capabilities of the children. These sets allow you to experience the real technology and learn it by playing.

Entry into the four different product lines is possible at any time. All of this taken together forms a logical concept where one fits with the other.

Building block for building block. It doesn't matter how demanding the models become because you can always return to the components from other fischertechnik sets.

To help you with the construction and discovery of the fascinating fischertechnik world, there is a comprehensive and easy to understand set of assembly instructions. For all of those who want to know more, there are the instructional activity booklets in the profi and computing construction sets with lots of background information, tasks and solutions or you can just browse through them.

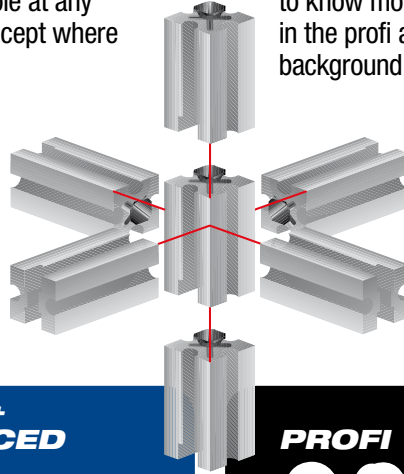

2

JUNIOR

5+



The fun of playing starts at the age of five with fischertechnik. The red junior line provides the first experience with technology and the way it functions. The motto is learning by playing and building with fast success.



BASIC + ADVANCED

7+



Seven-year olds develop their knowledge and capabilities with the blue line. The models are not only realistic and understandable in their function, but really robust in construction and for playing.



PROFI

9+



The black line, which starts at nine years of age, offers the technicians of tomorrow design construction sets that are very close to reality. Subjects such as mechanics, statics, pneumatics, electrical technology or regenerative energies guarantee outstanding experiences in the world of technology.



COMPUTING

8+ | 10+



If you love your computer, give him fischertechnik. Using graphic software, which is easy to use, children starting at 8 years old can program and control fischertechnik models and robots from the computer. It doesn't take long to get the feeling of success.



PLUS

For optimal supplementation, page 13
 Everything that makes fischertechnik still more attractive: fischertechnik PLUS provides light, movement, sound and more fun in playing.



Construction sets and more ...

For fischertechnik, the one-time construction and collection of the models is not important, on the contrary, it is the repeated searching and discovery, the independent and creative development of the person's own ideas and imagination and the art of being able to turn these into reality.



Didactic material

How does a gear box work? What is a planetary gear? How is the movement of a windshield wiper produced? How do you design a stable bridge? These questions are answered in the instructional activity booklets in the PROFI and COMPUTING construction sets with illustrations and easy-to-understand information.

Assembly instructions



Worksheets

Profi Oeco Power LPE 2
Natur und Technik

Regenerative Energiequellen

Wir alle benötigen tagtäglich riesige Mengen an Energie. Betrachte einmal einen ganz normalen Tageläuf:

Morgens wirst du von deinem Radiowecker geweckt. Dieser bezieht den Strom natürlich aus der Steckdose. Du stiehst auf, schaltest das elektrische Licht ein, Gusschiff mit warmem Wasser, das von der Zentralheizung mit Öl oder Gas erhitzt wurde. Danach trichnest du dir, die Haare mit dem elektrischen Fön. Die Zentralheizung hat auch bereits die Wohnung beheizt, damit du beim Frühstück nicht frierst. Das Wasser für den Tee wurde im elektrischen Wasserkocher oder auf dem Gasbrenner zum Kochen gebracht. Die Butter wurde über Nacht im Kühlschrank aufbewahrt.

Zur Schule fährst du dann mit dem Bus, dem Moped oder mit dem Auto, alle benötigen Treibstoff.

Suche noch 10 weitere Alltagsgegenstände oder -dinge, die deiner Meinung nach jede Menge Energie verbrauchen:

-
-
-
-
-
-
-
-
-
-

Wo kommt diese Energie her? Ein Großteil wird aus den fossilen Brennstoffen wie Kohle, Erdgas, Erdöl und Braunkohle gewonnen. Auch aus Kernenergie wird ein großer Teil unserer Elektrizität erzeugt.

Doch diese Arten der Energiegewinnung haben erhebliche Nachteile:

- Die fossilen Brennstoffe auf der Erde sind begrenzt.
- Bei der Verbrennung entstehen Schadstoffe, die die Umwelt verschmutzen, sowie CO₂, das für die ständige Erwärmung der Erdatmosphäre verantwortlich ist.
- Die Kernenergie birgt trotz hoher Sicherheitsstandards die Gefahr eines radioaktiven Unfalls. Außerdem entstehen radioaktive Abfälle, die nach viele tausend Jahren Radioaktivität ausstrahlen.

Activity Booklet

PROFI DECC TECH Bauschritt 1

Siegepack

■ Öffnen Sie das Siegepack. Schneiden Sie die Folie an den markierten Stellen ab. Nehmen Sie die Bauteile heraus, sortieren Sie sie nach den Farben in Behälter oder Behälter aus. Bitte beachten Sie, dass die Bauteile in den Behältern sortiert sein müssen, um die Arbeit zu erleichtern.

■ Das Siegepack enthält ein Bauteileverzeichnis mit einer Abbildung der Bauteile. Das Verzeichnis ist in drei Spalten unterteilt. Die Bauteile sind in drei Spalten unterteilt. Die Bauteile sind in drei Spalten unterteilt. Die Bauteile sind in drei Spalten unterteilt.

Aufgabe

Wie hoch ist die Brücke? Geben Sie die Höhe in cm an.

■ Die Brücke ist ein Modell einer Brücke. Sie ist aus fischertechnik Bauteilen gebaut. Die Brücke ist ein Modell einer Brücke. Sie ist aus fischertechnik Bauteilen gebaut. Die Brücke ist ein Modell einer Brücke. Sie ist aus fischertechnik Bauteilen gebaut.

Wissensfrage

Wie hoch ist die Brücke? Geben Sie die Höhe in cm an.

■ Die Brücke ist ein Modell einer Brücke. Sie ist aus fischertechnik Bauteilen gebaut. Die Brücke ist ein Modell einer Brücke. Sie ist aus fischertechnik Bauteilen gebaut. Die Brücke ist ein Modell einer Brücke. Sie ist aus fischertechnik Bauteilen gebaut.

Well-thought-out storage

Every fischertechnik building block has its place in the very practical and systematic storage system, which is available as a separate item.







The new products for 2010

NEW



6 Available starting in spring

Complete construction set with motor and battery tray. With over 600 components, you can build a motorized Ferris wheel or a merry-go-round. The Ferris wheel has a diameter of over 50 cm and is equipped with six gondolas — a model that creates a real fair atmosphere.

SUPER FUN PARK



- Includes XS motor and battery tray for 9V block (battery not included).
- 620 components
- 2 models

NEW



Available starting in summer

On the trail of James Watt, Michael Faraday and other famous inventors. The construction set brings new life to important moments of technology history. Important technological inventions can be reproduced as functional models, for example, an electric motor, cardan shaft, perpetuum mobile, a Morse telegraph and a generator. The didactic activity booklet provides additional background information. For little creative tinkerers and inventors starting with nine years old.

TECHNICAL REVOLUTIONS



- Includes the didactic activity booklet.
- Includes XS motor and battery tray for 9V block (battery not included).
- 220 components
- 11 models

NEW



Available starting in summer

The new complete beginner's packet for kids starting with eight years old. Using over 180 components and with the help of sensors (phototransistor, push-button switch) and the actuators (XS motor, indicator lights), children can construct eight easy to understand models such as a lighthouse with a blinking light, a merry-go-round or an automatic sliding door. The new control ROBO LT Controller with three inputs for sensors and two outputs for motors or indicator lights has a USB interface. The new software ROBO Pro Light allows quick and childish easy programming. The detailed didactic accompanying material supports the learning process for children and explains the programming in a way, which is easy to understand. For tomorrow's engineers.

ROBO LT BEGINNER LAB

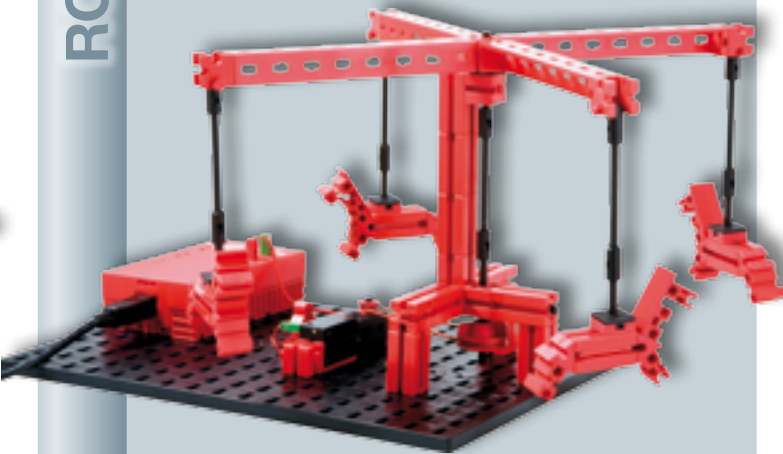

- Includes didactic accompanying material.
- Includes ROBO LT Controller as control (USB interface).
- Includes control software ROBO Pro Light.
- Includes XS motor, two indicator lights, phototransistor and push-button switch.
- 180 components • 8 models

NEW



Available now

Explore unknown areas, measure distances, follow trails, show driving directions by means of blinking signals, recognize colors, measure temperatures, avoid obstacles without touching them, recognize day and night, turn headlights on and off automatically and trigger an alarm etc. The ROBO TX Explorer sensors can do all of this and lots more: The NTC resistor, the photoresistor, the ultrasonic distance sensor, the infrared color sensor and the specially developed trail sensor. Thanks to two encoder motors, the tracks can be controlled precisely and steered synchronically. With the rescue robot, which is contained as a model, the construction set provides the ideal basis for participation in the RoboCup.

ROBO TX EXPLORER



- Includes the didactic activity booklet.
- Includes two encoder motors, three indicator lights, buzzer, NTC resistor, photoresistor, ultrasonic distance sensor, optical color sensor and an IR trail sensor.
- 400 components • 6 models

JUNIOR 5+

Kids can celebrate their first building success with the easy-to-understand assembly. Concentration and motor skills are playfully promoted with the handy components and the many possible variations.



8



STARTER

The construction set for the playful start into the fischertechnik world.



Components:	50	Dimension	
Models:	4	(mm):	280x65x180
Item No.:	30 323	Vol (m ³):	0,0033
EAN:	4006209303238	Weight:	325 g



JUMBO PACK

14 models and of these four can be built at the same time. For play groups or friends!



Components:	135	Dimension	
Models:	14	(mm):	465x80x320
Item No.:	16 551	Vol (m ³):	0,0119
EAN:	4006209165515	Weight:	1205 g



CARTS



Components:	85	Dimension	
Models:	3	(mm):	225x65x150
Item No.:	505 279	Vol (m³):	0,0022
EAN:	4048962069402	Weight:	220 g

BIKES



Components:	80	Dimension	
Models:	3	(mm):	225x65x150
Item No.:	505 278	Vol (m³):	0,0022
EAN:	4048962069396	Weight:	210 g



CABLE CARS

Glide down the slope on a 6-meter long cable with the gondola clear up at the top and then with the freight elevator clear down to the bottom. Have fun.



Components:	120	Dimension	
Models:	3	(mm):	330x80x235
Item No.:	41 859	Vol (m³):	0,0062
EAN:	4006209418598	Weight:	605 g

AIRCRAFT



Components:	100	Dimension	
Models:	3	(mm):	280x65x180
Item No.:	96 776	Vol (m³):	0,0033
EAN:	4006209967768	Weight:	295 g

FUN CARS



Components:	85	Dimension	
Models:	3	(mm):	280x65x180
Item No.:	96 777	Vol (m³):	0,0033
EAN:	4006209967775	Weight:	295 g



10



UNIVERSAL II

The universal genius with vice, lifting platform with car, sewing machine and an entire amusement park. Several models can be built at the same time. Here, the everyday technology is understood and experienced.

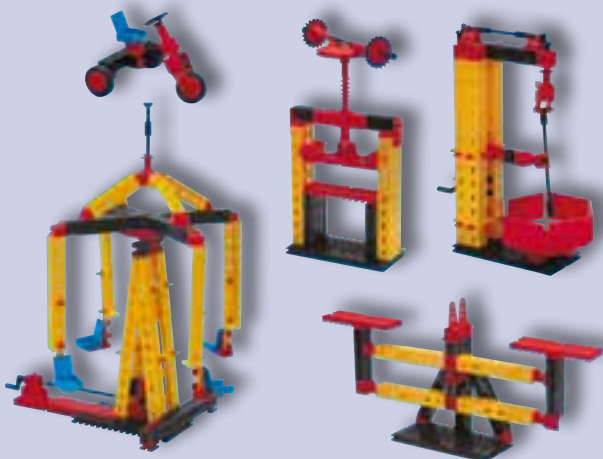

Ideal additions (page 13):
Motor Set XS · Motor Set XM · Power Set

Components:	400	Dimension	
Models:	48	(mm):	465x80x320
Item No.:	93 290	Vol (m ³):	0,0119
EAN:	4006209932902	Weight:	1770 g



SWEEPERS

Crumbs on the breakfast table and scraps of paper on the floor of the kid's room — no problem for the five different sweeping machines. The operational models are equipped with up to two high quality and durable foamed plastic brushes. So even dirt on the edges of the curb and in the corners doesn't have a chance. The removable catch container makes it easy to dispose of the waste. This makes cleaning really fun!



Ideal additions (page 13):
Motor Set XS · Motor Set XM · Sound+Lights · Accu Set

Components:	310	Dimension	
Models:	5	(mm):	465x80x320
Item No.:	500 878	Vol (m ³):	0,0119
EAN:	4048962003246	Weight:	1180 g

Now you can get started. For the advanced in the fischertechnik group of technicians! The function is understandable with lots of details such as four-wheel steering and track chains that crawl over the terrain. Cranes that lift heavy loads. Merry-go-rounds that make

the figures fly and really robust in construction and for playing. With genuine functions and lots of attachment and expansion possibilities. Detailed assembly instructions lead to the finished models in logical steps.



FIRE TRUCKS

The six different fire trucks have operational fire extinguishing equipment. The extendable turntable ladder provides the capability to fight fires and conduct rescue at various heights. Here, fast help is guaranteed. The extendable outriggers secure the vehicle for difficult operations. Various models such as the airport fire department with a roof monitor or an implement truck can be assembled. A radio message from the headquarters — MOVE INTO ACTION!



Ideal additions (page 13):
Motor Set XS · Motor Set XM · Control Set · Sound+Lights · Accu Set

Components:	430	Dimension	
Models:	6	(mm):	465x80x320
Item No.:	500 879	Vol (m³):	0,0119
EAN:	4048962003253	Weight:	1570 g



XL BULLDOZER

Blocky tracked vehicles are cleaning up! This construction set offers four bulldozer types, which remain stable during play, with realistic details such as cable winch, dozer blade that can be raised and lowered and nonskid tracks. Mount up, let's go!



Ideal additions (page 13):
Motor Set XS · Motor Set XM · Control Set · Sound+Lights · Accu Set

Components:	740	Dimension	
Models:	4	(mm):	465x80x320
Item No.:	505 280	Vol (m³):	0,0119
EAN:	4048962069419	Weight:	1490 g

ADVANCED 7+

This line is a real challenge for real hobby inventors. With up to 800 parts and diverse functions, these constructions sets „Super Fun Park“, „Super Trucks“ and „Super Cranes“ do justice to their names.

12



NEW



SUPER FUN PARK

Complete construction set with motor and battery tray. With over 600 components, you can build a motorized Ferris wheel or a merry-go-round. The Ferris wheel has a diameter of over 50 cm and is equipped with six gondolas — a model that creates a real fair atmosphere.



• Includes XS motor and battery tray for 9V block (battery not included).
Ideal additions (page 13):
Sound+Lights · Power Set

Components:	620	Dimension	
Models:	2	(mm):	465x80x390
Item No.:	508 775	Vol (m³):	0,0145
EAN:	4048962095647	Weight:	2500 g



SUPER CRANES

Caution: Giants at work! More than one meter high and the boom is over a meter long, turns at the top or bottom and is built for really big loads! With traveling carriage and lifting tackle, mobile or stationary

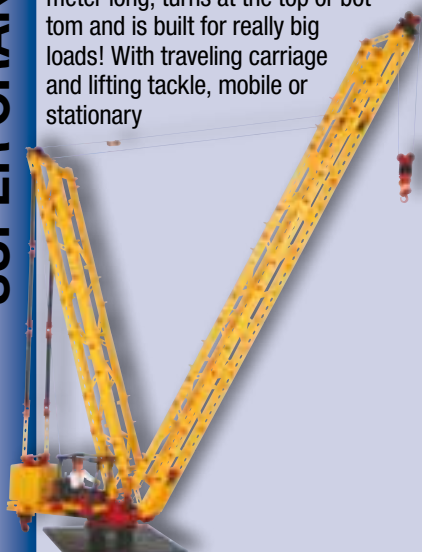

Ideal additions (page 13):
Motor Set XS · Motor Set XM · Sound+Lights · Control Set · Power Set

Components:	780	Dimension	
Models:	3	(mm):	465x100x390
Item No.:	41 862	Vol (m³):	0,0181
EAN:	4006209418628	Weight:	2280 g



SUPER TRUCKS

Six different heavy duty trucks hit the road! The low-bed trailer for really heavy equipment such as the big "Big Bulldozer", long-timber truck with steerable trailer, the heavy-duty crane with double-axle steering and extendable supports or the tractor truck with unhookable trailer and powerful semi-trailer tractor. For small freight forwarders.



Ideal additions (page 13):
Motor Set XS · Motor Set XM · Sound+Lights · Control Set · Accu Set

Components:	800	Dimension	
Models:	6	(mm):	465x100x390
Item No.:	77 790	Vol (m³):	0,0181
EAN:	4006209777909	Weight:	2850 g

MOTOR SET XS



Thanks to the compact measurements, this motor can be installed almost anywhere. In addition to the building blocks, gearbox parts and toothed gears, the set also contains a safety battery tray with integrated pole-reversing switch for nine volt block batteries (battery not included). Performance data: Voltage 9V ..., max. output 1.0 W at 6000 RPM

Components: 45	Dimension (mm): 225x65x150
Item No.: 505 281	Vol (m³): 0,0022
EAN: 4048962069426	Weight: 200 g

SOUND+LIGHTS



If you want to breathe still more „life“ into the fischertechnik models using sounds and lights then the „Sound+Lights Set“ is the ideal solution! Up to three different sounds, which can be activated with push-buttons or automatically with digital inputs, can be placed on the sound module. Depending on the requirement, the sounds can be replaced very simply per USB. The blink connection, which is also included, allows the operation of up to eight indicator lights as blinking lights. The set contains a sound module with blink electronics, a USB cable, two indicator lights with various colored luminous caps and a battery tray for a nine volt block (battery not included). Only Windows® compatible

Components: 30	Dimension (mm): 225x65x150
System: Windows®	Vol (m³): 0,0022
Item No.: 500 880	Weight: 270 g
EAN: 4048962003260	

ACCU SET



Charger, which is controlled by a microcontroller and provides reliable protection against overcharging. Very short charging time, max. two hours, powerful NiMH rechargeable battery pack with fuse for protection against a short circuit, 8.4V, 1500mAh.

Components: Charger + battery pack in one	Dimension (mm): 225x65x150
Item No.: 34 969	Vol (m³): 0,0022
EAN: 4006209349694	Weight: 880 g

13

MOTOR SET XM



High performance geared motor in compact plastic casing with numerous possibilities for attachments. With many toothed gears, axles and gearbox parts.

- Performance data: Voltage 9V ..., max. output 3.0 W about 340 RPM
- **Additionally required is Accu Set or Power Set**

Components: 40	Dimension (mm): 225x65x150
Item No.: 505 282	Vol (m³): 0,0022
EAN: 4048962069433	Weight: 275 g

CONTROL SET



The four channel infrared remote control allows you to control fischertechnik models from a distance as well. Up to three motors and one servo can be controlled proportionally. This means an infinitely variable turning angle of the steering wheel and infinitely variable speed control. Up to four receivers can be operated with the remote control, which allows numerous applications.

- **Additionally required is Accu Set**

Components: Controller, receiver, servo	Dimension (mm): 225x65x150
Item No.: 500 881	Vol (m³): 0,0022
EAN: 4048962003277	Weight: 370 g

POWER SET



Power unit and infinitely variable control unit. The power supply from the electrical socket for all fischertechnik models.

- Performance data: 9V ..., 2,5 A

Components: Power unit + control unit in one	Dimension (mm): 225x65x150
Item No.: 505 283	Vol (m³): 0,0022
EAN: 4048962069440	Weight: 425 g

CREATIVE BOX 1000



More than 700 components from the current fischertechnik assortment. Packed in BOX 1000 with building board 390 x 270 mm as cover.

Components: 720	Dimension (mm): 390x95x270
Item No.: 91 082	Vol (m³): 0,0100
EAN: 4006209910825	Weight: 2750 g

BOX 1000



Practical storage box with eight sorting boxes and 32 sorting partitions. The cover also serves as the big building board 390 x 270 mm.

Item No.: 30 383	Dimension (mm): 390x95x270
EAN: 4006209303832	Vol (m³): 0,0100
	Weight: 1830 g



HYDRO CELL KIT

How does a fuel cell work? How can you produce hydrogen with it? This construction set provides knowledge for all areas associated with this exciting topic. With the fuel cell and the additional solar module, interesting additional models can be built in connection with the construction set, „Oeco Tech“. The didactic activity booklet offers assistance. All of your questions are answered.

(NOTE: The OecoTech item No. 505 284 is absolutely required for operation.)



- Includes the didactic activity booklet, „Energy from Hydrogen“
- Includes reversible fuel cell with integrated hydrogen storage unit, solar module (1.2 V; 440 mA)

Components:	20	Dimension	
Models:	6	(mm):	225x65x150
Item No.:	505 285	Vol (m ³):	0,0022
EAN:	4048962069464	Weight:	530 g



TECHNICAL REVOLUTIONS

On the trail of James Watt, Michael Faraday and other famous inventors. The construction set brings new life to important moments of technology history. Important technological inventions can be reproduced as functional models, for example, an electric motor, cardan shaft, perpetuum mobile, a Morse telegraph and a generator. The didactic activity booklet provides additional background information. For little creative tinkerers and inventors starting with nine years old.



- Includes the didactic activity booklet.
- Includes XS motor and battery tray for nine volt block (battery not included).

Components:	220	Dimension	
Models:	11	(mm):	465x80x320
Item No.:	508 776	Vol (m ³):	0,0119
EAN:	4048962095654	Weight:	1500 g

DA VINCI MACHINES

This construction set combines several mechanical models, whose origin goes back to designs from Leonardo da Vinci: file cutting machine, pivoting bridge and chariot. An activity booklet with numerous illustrations and descriptions for the original designs from Leonardo da Vinci provides information, which is worth learning. History you can touch!



- Includes the didactic activity booklet „Machines from Leonardo da Vinci“

Components:	260	Dimension	
Models:	10	(mm):	465x80x320
Item No.:	500 882	Vol (m ³):	0,0119
EAN:	4048962003284	Weight:	1540 g

OECO TECH

„Renewable energies“ will become our most important suppliers of energy in the future. The production, storage and use of electricity from natural energy sources such as water, wind and the sun are graphically illustrated using various models and numerous experiments. This is the way to create an understanding of the future energy forms. The hydro cell kit offers an ideal addition. With this expansion construction set, you can build several models and operate them with a fuel cell.



- Includes the didactic activity booklet, „Renewable Energies“
- Includes solar motor, solar module (1.2 V; 440 mA) and Gold Cap energy storage unit.

Components:	320	Dimension	
Models:	10	(mm):	465x80x320
Item No.:	505 284	Vol (m ³):	0,0119
EAN:	4048962069457	Weight:	1710 g

Jump into the car, put it in gear and get going. But how does the technology work that allows us to use a low gear to go, slowly, but easily up a mountain or to fly down the mountain in a high gear? How does a kitchen appliance or a planetary gear work? Why don't

bridges collapse and why does a wobbly table become stable with four cross struts. These and other questions are answered in detail in the PROFI line.



MECHANIC+STATIC

The ultimate technology construction set for all future mechanical engineers, technicians and engineers: How does a gear box work? What is a planetary gear? How is the movement of a windshield wiper produced? How do you design a stable bridge? The answers to these and other elementary questions from the subject areas of mechanics and statics are found in this construction set with 30 different models.



- Includes the instructional activity booklet „Mechanics+Statics“
- Includes Mini Motor, switch and battery tray for nine volt block (battery not included).

Components:	500	Dimension	
Models:	30	(mm):	465x100x390
Item No.:	93 291	Vol (m³):	0,0181
EAN:	4006209932919	Weight:	2150 g



PNEUMATIC II

The PROFI Pneumatics II provides playful learning of the basics of this „airy“ technology and shows, using numerous application examples, the way that pneumatic valves and cylinders work in connection with a compressor and an air cell. It contains four double-acting pneumatic cylinders, three 4/3 way hand valves and one electrically operated compressor with air cell.



- Includes the instructional activity booklet „Pneumatics: Create Movement with Compressed Air“
- Includes compressor with Mini Motor, switch and battery tray for nine volt block (battery not included).

Components:	400	Dimension	
Models:	8	(mm):	465x80x320
Item No.:	77 791	Vol (m³):	0,0119
EAN:	4006209777916	Weight:	1950 g



E-TECH

Electrical circuits, electromechanics and electronic controls. Using functional models, for example, the principle of series and parallel connections and the control of a traffic light are explained step by step. For this purpose, the „E-Tech Modul“ (see above) with eight set programs that control, for example, a burglar alarm with a buzzer, a hand dryer with a light barrier or a garage door with a magnetic sensor and these devices are controlled through three inputs for digital sensors such as a probe, photo-transistor and reed contact and an output for a motor or two indicator lights.



- Includes the instructional activity booklet „Electrical Technology“
- Includes Mini Motor, E-Tech Modul, sensor, lightbarrier, magnetic sensor and buzzer, battery tray for nine volt block (battery not included).

Bauteile:	260	Dimension	
Modelle:	12	(mm):	465x80x320
Art.Nr.:	91 083	Vol (m³):	0,0119
EAN:	4006209910832	Weight:	1710 g



NEW



ROBO LT BEGINNER LAB

The new complete beginner's packet for kids starting with eight years old. Using over 180 components and with the help of sensors (phototransistor, push-button switch) and the actuators (XS motor, indicator lights), children can construct eight easy to understand models such as a lighthouse with a blinking light, a merry-go-round or an automatic sliding door. The new control ROBO LT Controller with three inputs for sensors and two outputs for motors or indicator lights has a USB interface. The new software ROBO Pro Light allows quick and childishly easy programming. The detailed didactic accompanying material supports the learning process for children and explains the programming in a way, which is easy to understand. For tomorrow's engineers.

- Includes didactic accompanying material.
- Includes ROBO LT Controller as control (USB interface).
- Includes control software ROBO Pro Light.
- Includes XS motor, two indicator lights, phototransistor and push-button switch.
- **Additionally required is Accu Set or Power Set**

Components:	180	Dimension	
Models:	8	(mm):	465x80x320
Item No.:	508 777	Vol (m³):	0,0119
EAN:	4048962095661	Weight:	2000 g



ROBO TX TRAINING LAB

COMPUTING beginner construction set with everything you need for this: Consisting of 200 components for the building of six mobile robot models, for example, driverless transport system, obstacle detector and trail searcher etc., two encoder motors for exact positioning, „Motor XS“, infrared trail sensor, two sensing devices. It also includes the new compact and powerful „ROBO TX Controller“ with Bluetooth radio interface, 32-bit processor (200 MHz), eight universal inputs and 8 MB RAM (2 MB flash), including software „ROBO Pro“ for programming. The extensive accessories provide many possibilities for creativity.

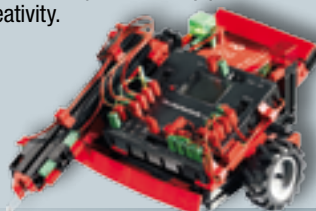

- Includes the didactic activity booklet, „Programming and Control of fischertechnik Robots with the PC.“
- Includes ROBO TX Controller, software ROBO Pro
- Includes 2 each encoder motors, Motor XS, infrared trail sensor, 2 each sensing devices
- **Additionally required is Accu Set**

Components:	310	Dimension	
Models:	11	(mm):	465x80x320
Item No.:	505 286	Vol (m³):	0,0119
EAN:	4048962069471	Weight:	1960 g

ROBO PRO SOFTWARE



Simple entry for beginners through programming of flow charts consisting of various software building blocks. The exchange of the data between the software building blocks and the subprograms can be done through variables and graphical connections as well. This allows the program functions to be shown in an understandable manner. There are no problems with the preparation of teach-in programs or data exchange with other Windows® software.

System:	Windows® XP, Vista, 7	Dimension	
Item No.:	93 296	(mm):	210x25x150
EAN:	4006209932964	Vol (m³):	0,0008
		Weight:	105 g

ROBO TX CONTROLLER



The controller with 32-bit processor, display, high storage capacity and with compact casing (90x90x15mm) offers numerous attachment possibilities on five sides. With integrated Bluetooth radio interface (2.4 GHz, range about 10 m). Several „ROBO TX Controller“ can be coupled together.

- 32-bit ARM 9 processor (200 MHz)
- Storage capacity: 8 MB RAM, 2 MB flash
- Weight only 90g
- 8 Universal inputs: Digital, analog 0-9V DC, analog 0-5kΩ
- 4 fast counting inputs: Digital, frequency up to 1kHz
- 4 motor outputs, 9V, 250mA: Speed infinitely variable, short circuit proof, alternatively 8 individual outputs
- 2 expansion connections: I2C and RS 485 for coupling of additional „ROBOTX Controller“
- Display: 128x64 pixel, monochrome
- USB interface: USB 2.0 (1.1 compatible), max. 12 MB, including mini-USB socket connector
- Programmable with „ROBO Pro“ or C compiler (not included)
- Includes USB connection cable.

• **Additionally required is Power Set or Accu Set**

Item No.:	500 995	Dimension	
EAN:	4048962003826	(mm):	225x65x150
		Vol (m³):	0,0022
		Weight:	460 g

Construct machines and robot models, program the control software on the PC and put the whole thing into motion. You need a commercially available PC with the Windows® operating system, (starting with Win XP or later), the easy-to-use graphic fischertechnik

nik software „ROBO Pro“ to program the commands that the robot is to carry out and in addition the „ROBO TX controller.“ This converts the computer commands into control signals for the motors.

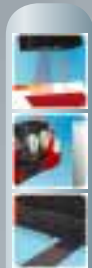

NEW



ROBO TX EXPLORER

Explore unknown areas, measure distances, follow trails, show driving directions by means of blinking signals, recognize colors, measure temperatures, avoid obstacles without touching them, recognize day and night, turn headlights on and off automatically and trigger an alarm etc. The ROBO TX Explorer sensors can do all of this and lots more: The NTC resistor, the photoresistor, the ultrasonic distance sensor, the infrared color sensor and the specially developed trail sensor. Thanks to two encoder motors, the tracks can be controlled precisely and steered synchronically. With the rescue robot, which is contained as a model, the construction set provides the ideal basis for participation in the RoboCup.

- Includes the didactic activity booklet.
- Includes two encoder motors, three indicator lights, buzzer, NTC resistor, photoresistor, ultrasonic distance sensor, optical color sensor and an IR trail sensor.
- **Additionally required is ROBO TX Controller, Software ROBO Pro, Accu Set**

Components:	400	Dimension	
Models:	6	(mm):	465x80x320
Item No.:	508 778	Vol (m³):	0,0119
EAN:	4048962095678	Weight:	1700 g



ROBO PNEUVAC

The themes, pneumatics and vacuum technology, are illustrated with the aid of five models. The electro-magnetic valves, which are included, allow the control of the models with a PC.

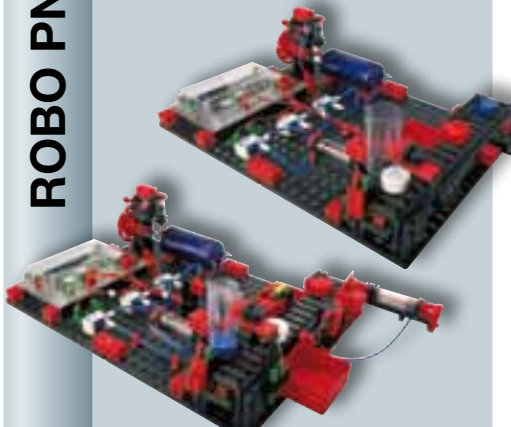

- Includes vacuum suction apparatus, three pneumatic cylinders, compressor, two lights, two phototransistors, optical color sensor, conveyor belt and 2x Mini Motor
- **Additionally required is ROBO TX Controller, Software ROBO Pro, Accu Set or Power Set**

Components:	490	Dimension	
Models:	5	(mm):	465x80x320
Item No.:	500 883	Vol (m³):	0,0119
EAN:	4048962003291	Weight:	2150 g



INDUSTRY ROBOTS II

Three reality-based and fully functional industry robots with precise details: triple-axis industry robot and two welding robots.



- Includes the instructional activity booklet "Programming and Control of fischertechnik Robots with the PC"
- Includes Power Motor, 3x Mini Motor, 8 sensors and ball plug-in light
- **Additionally required is ROBO TX Controller, Software ROBO Pro, Accu Set or Power Set**

Components:	360	Dimension	
Models:	3	(mm):	465x80x320
Item No.:	96 782	Vol (m³):	0,0119
EAN:	4006209967829	Weight:	1960 g

Sales Promotion

- ① End consumer brochure item No. 39 090
- ② Hourly schedule ,20x15 cm item No. 43 353
- ③ Shopping bag, 46x59 cm item No. 43 355
- ④ Specialty retailer sticker, 30x6 cm
(German or English)
- ⑤ Play box item No. 41 682
- ⑥ Luminous logo, 125x20 cm item No. 50 460
- ⑦ Top sign, 125x30 cm item No. 39 917
100x30 cm item No. 47 227
- ⑧ Decorative model windmill with light and solar
module, 26x20x52 item No. 503 546
- ⑨ Poster „ADVANCED“, DIN A1 item No. 39 125
- ⑩ Banner, 200x80 cm item No. 500 887
- ⑪ Poster „COMPUTING“, DIN A1 item No. 39 126
- ⑫ Shelf strips, 125x3.5 cm item No. 39 911
- ⑬ Informative and exciting POS video that boosts sales
(upon request)



⑩

⑫

We support your sales with highly effective and attention-getting measures and aids so that you can achieve the optimal presentation at the point of sale (POS) and in the display window for the best-possible attraction of the end consumer.



3



4

The play box allows the little designers to experience the Fischertechnik world in a realistic and gripping way. With the many components and instructions, the play box provides optimal support for your events. The nice thing about it is that you can use it again and again.

5



7



9



11



13



Learning by Playing



20

The construction sets from fischertechnik

- ... promote eye and hand coordination;
- ... promote gross and fine motor functions;
- ... promote the spatial powers of imagination;
- ... promote fantasy and creativity;
- ... promote logical thought; and
- ... provide basic technical understanding.

The products from fischertechnik are learning toys „made in Germany“ and are produced at the location in Tumlingen in the Black Forest. All construction sets can be ideally combined with one another. The high acceptance by parents, teachers and engineers makes fischertechnik a successful educational material for schools and universities.

The Awards



FAN CLUB

More than 30,000 fans are members at no cost in the fischertechnik Fan Club. Every fan regularly receives current information and has his personal member identification. In this way, we guarantee that the important information such as information about new items reaches our target group quickly.

Fan Club Day

On Fan Club Day, fischertechnik opens its gates to the Fan Club members. The fans receive the exclusive opportunity to take a peek behind the curtains of the traditional brand. This creates trust in the quality of the products. The little visitors receive information about new products and can participate in COMPUTING workshops. Join-in activities and prize games are particularly interesting for the kids. Customer relations at the highest level!



The Fan Club at www

On our Web site, we offer the Fan Club members the opportunity to exchange tips, to make contact with other fans and to ask us questions. This is an offer that is continually used by the fans. So we are in direct contact with our customers every day. This creates proximity to the market! In the model gallery, fans publish pictures of their models. Other fans vote on these model suggestions and select the winner for the quarter. So others catch the fischertechnik fever this way!



Fan Club NEWS

The NEWS appears two times a year and offers the readers a lot of current information about the products, new items and technology. For the little fans, there is a puzzle page and in each edition the Fan Club model with assembly instructions. These assembly instructions are only found in the NEWS. This allows our customers to always be up-to-date!

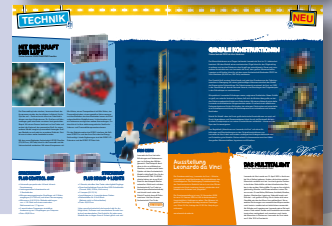

„We would be happy to develop an opportunity especially for you as a dealer to present yourself in this environment. Just get in touch with us!“

How does a gear box work? What is a planetary gear? How is the movement of a windshield wiper produced? These are questions, which our instructional activity booklets illustrate and are explained in a way that is easy to understand. This starts with elementary subjects such as mechanics, statics, electronics and information science etc. and progresses to the practical implementation, which can be understood quickly, of everyday technical devices such as traffic lights, fans and a lifting tackle and then moves on to the technically refined and demanding solutions for robotics and computing.

Additional worksheets can be downloaded from the fischertechnik Web site and with the thematically developed questions and answers, these are an additional instrument to provide understanding of the corresponding instruction in a simple and precise manner and to test the learning success.

In addition, there is the very practical and systematically constructed storage system where each part has its place and is quickly found and helps with the daily didactic work (available separately).

The instructional construction sets from fischertechnik are specially designed for use in technical instruction and in technical facilities for the basic and secondary level. Here, there are the following topics: Mechanics, statics, electrical technology, regenerative energies and measuring, controlling and regulating (information science, mechatronics and computing). This is supported by books, instructional activity booklets and worksheets. For this purpose, there are intelligent storage systems that provide order and reliability for the everyday things at school.

**Additional information is available at:
www.fischertechnik.de**

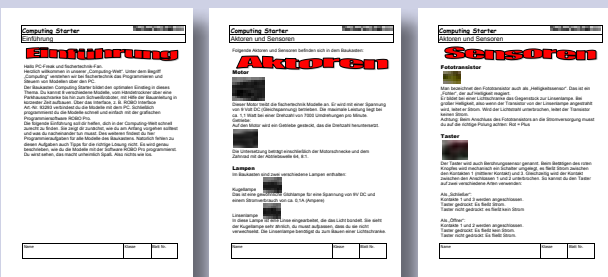
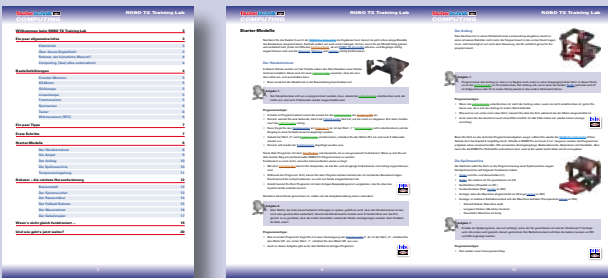
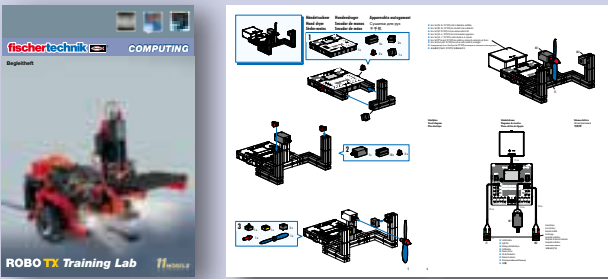

Well-thought-out storage

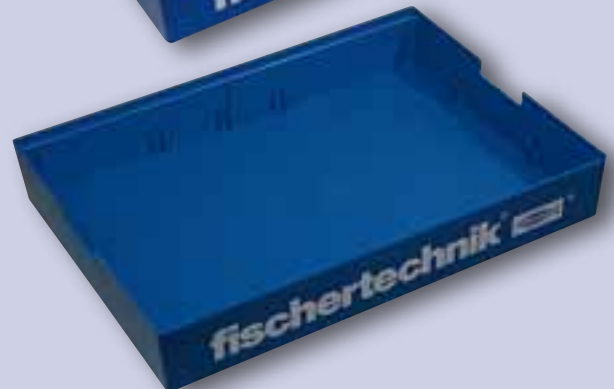

For training and in-service training

Compact function models, which are already assembled, provide ideal training and demonstration models for training and in-service training and industrial automation. Available in the 9V standard voltage and in the worldwide 24V industrial standard.

Training Models

3-D-ROBOT

3-axis robot with grappler,
4 direct current motors, 4 limit switches,
4 pulse sensing devices for
measuring distances.
All probes are potential-free.

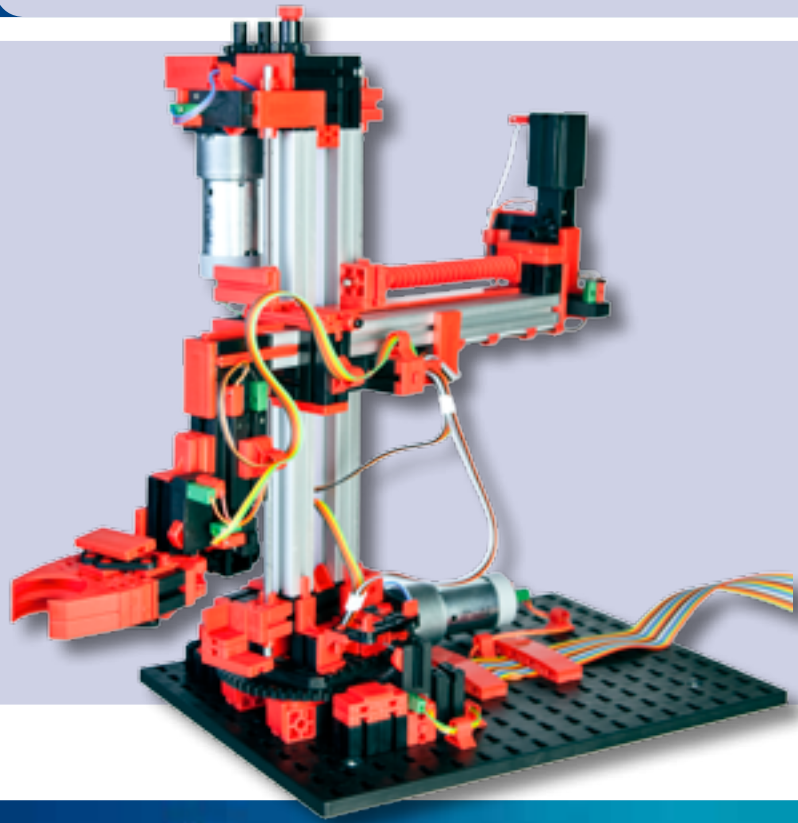

23

Plan+Simulation

The function models from fischertechnik, plan+simulation, are a proven and inexpensive means to plan and to develop industrial controls with the associated software and to test processes. They are employed worldwide in the areas of training, development and presentation.

The flexibility and the modularity of the fischertechnik system in connection with the industrially adapted sensors and actors as well as the controls from leading manufacturers open up almost unlimited possibilities for hardware simulation. Complicated technical systems are presented realistically and thus perfectly simulated so that they are understandable for everyone. This makes investment decisions easier and reduces the costs for the correction of planning mistakes.

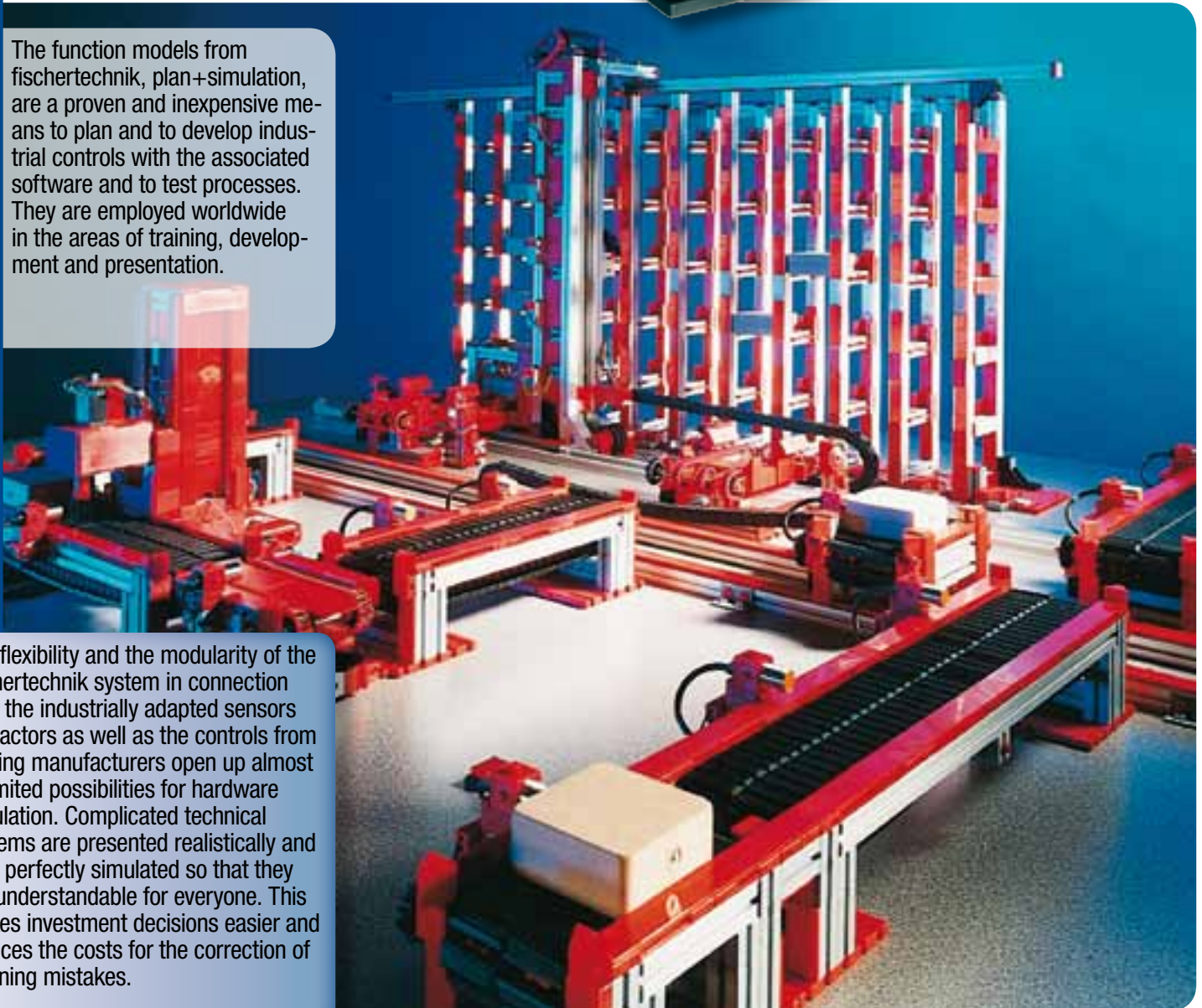



WHAT DO YOU GET FROM THIS AS A TOY DEALER?

A uniform system with design construction sets at the highest level and the best quality as well the strong fischertechnik brand as a reference for your pedagogical and valuable range of toy products. Over 30,000 fan club members, optimal support and a well-founded assortment system and diverse additional products serve to promote your sales throughout the year.

WHAT DO CHILDREN GET FROM THIS?

Only the best and they can play and play and play. Creative and concentrated when building models and then fun with role playing with each other.

WHAT DO PARENTS GET FROM THIS?

The certainty that their child can playfully enter the world of technology and understand and learn about it. The independent construction of continually new fischertechnik models promotes logical thinking and creativity. Thus, you are supporting the natural talent of your children to grasp technology in the truest sense of the word. The fischertechnik world of your children is boundless because all construction sets fit ideally together and supplement each other.

fischertechnik GmbH
Weinhalde 14-18, D-72178 Waldachtal
Phone +49 74 43/12-48 64, Fax +49 74 43/12-45 91
E-mail: info@fischertechnik.de



The right to errors and technical and assortment changes is reserved. Liability for printing errors and deficiencies is excluded. Catalogue not valid for the USA.



World of fischer

Befestigungssysteme
 Automotive Systems
 Prozessberatung
 fischertechnik

