



Building Blocks For Life

fischertechnik 



Understand technology by playing.

2012

This is the way it works: **FOUR** productlines and **ONE** theme

The fischertechnik basic building block can be built on all six sides. This „many-sided“ building block forms the basis for all fischertechnik construction sets, which are put together according to age and capabilities of the children. These sets allow you to experience the real technology and learn it by playing.

Entry into the four different product lines is possible at any time. All of this taken together forms a logical concept where one fits with the other.

Building block for building block. It doesn't matter how demanding the models become because you can always return to the components from other fischertechnik sets.

To help you with the construction and discovery of the fascinating fischertechnik world, there is a comprehensive and easy to understand set of assembly instructions. For all of those who want to know more, there are the instructional activity booklets in the profi and computing construction sets with lots of background information, tasks and solutions or you can just browse through them.

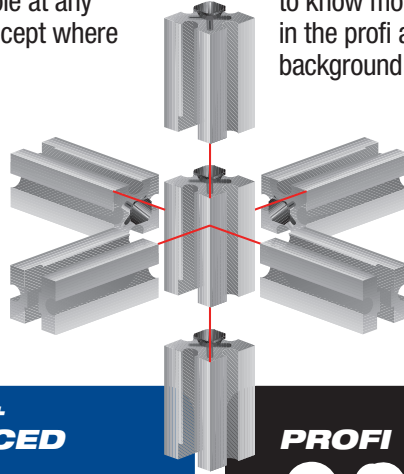

2

JUNIOR
 5+



The fun of playing starts at the age of five with fischertechnik. The red junior line provides the first experience with technology and the way it functions. The motto is learning by playing and building with fast success.



**BASIC +
ADVANCED**
 7+



Seven-year olds develop their knowledge and capabilities with the blue line. The models are not only realistic and understandable in their function, but really robust in construction and for playing.



PROFI
 9+



The black line, which starts at nine years of age, offers the technicians of tomorrow design construction sets that are very close to reality. Subjects such as mechanics, statics, pneumatics, electrical technology or regenerative energies guarantee outstanding experiences in the world of technology.



COMPUTING
 8+ | 10+



If you love your computer, give him fischertechnik. Using graphic software, which is easy to use, children starting at 8 years old can program and control fischertechnik models and robots from the computer. It doesn't take long to get the feeling of success.



PLUS

For optimal supplementation, page 11. Everything that makes fischertechnik still more attractive: fischertechnik PLUS provides light, movement, sound and more fun in playing.



Scan me!

The new products for 2012

NEW



Available as of March

Balls race on the unique flex-rails through various obstacle courses. They can be accelerated and decelerated by a launching lever or the pretensioned catapult, cause chain reactions, shoot through loops and run over seesaws or are moved back up by an elevator with counter weight. The Rolling Action Set can be combined perfectly with the PROFI Dynamic Set.

ROLLING ACTION

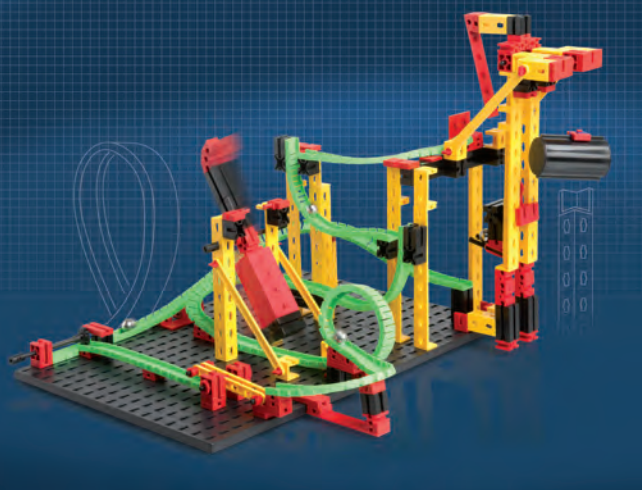

- Incl. 11 flex-rails and 4 balls
- Incl. detailed, easy-to-understand assembly instructions
- Components: 260
- Models: 6

NEW



Available as of June

How does a balloon drive or a bending rod drive work? What is the difference between a friction drive and a rubber-band drive. How can wind be used as a drive? This set provides a glimpse into how different types of drives work. The brawny offroad vehicle with functioning steering and suspension can also be combined perfectly with the Motor Set XM and Control Set for remote control. The instructional activity booklet provides a great deal of interesting information. For young engineers from age 9!

CARS & DRIVES

IDEAL ADDITIONS ARE:

Motor Set XM · Control Set · Sound+Lights · Accu Set



- Incl. instructional activity booklet
- Incl. friction motor
- Components: 270
- Models: 8

NEW



Available as of June

This play-and-learn construction set helps children learn the principles of pneumatics and uses realistic models to demonstrate how compressors, pneumatic valves and cylinders work. The new, powerful and compact compressor guarantees a reliable supply of compressed air to the models. In addition to vehicles such as front loaders, hay bale pickers and tree trunk grips, other educational models provide young inventors with background knowledge on the subject of pneumatics in combination with the instructional activity booklet.

IDEAL ADDITIONS ARE:
Accu Set



- Incl. instructional activity booklet
- Incl. compressor, 4 pneumatic cylinders, four 4/3-way manual valves, battery holder for 9V block batteries (not including battery)
- Components: 360
- Models: 8

PNEUMATIC 3

NEW



Available as of March

The subjects of electro-pneumatics and vacuum technology are demonstrated clearly with the aid of fascinating models such as the pneumatic motor, color sorting robot for colored parts, ball obstacle course and pinball machine. The new, powerful and compact compressor guarantees a reliable supply of compressed air to the models. The electro-magnetic valves included allow remote control of the models with a PC.

ADDITIONAL REQUIRED:
ROBO TX Controller · Software ROBO Pro · Power Set or Accu Set

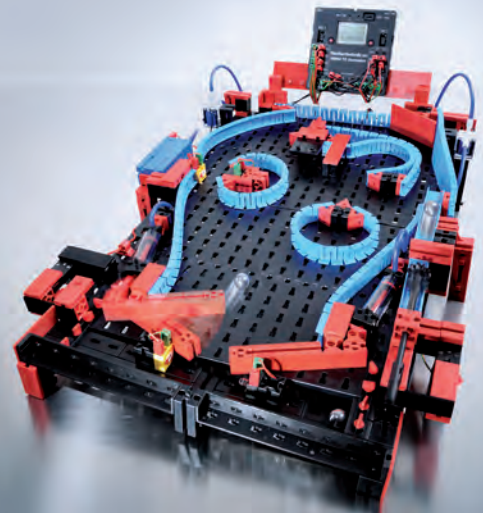

- Incl. related instructional material on CD
- Incl. compressor, miniature motor, 2x solenoid valves, optical color sensor, vacuum exhaustor, 3x cylinders with spring, 2x photo-transistors, 2x lens tip lamps, 11 flex-rails
- Components: 400 • Models: 4

ROBO TX ELECTROPNEUMATIC

JUNIOR 5+

Kids can celebrate their first building success with the easy-to-understand assembly. Concentration and motor skills are playfully promoted with the handy components and the many possible variations.



6



LITTLE STARTER

Starter set for young engineers from age 5. The large, easy-to-hold parts and assembly instructions written specifically for young children ensure quick construction success. Design work with this set develops important skills such as eye-hand coordination as well as gross and fine motor skills. Six models can be built: Dump truck, helicopter, power shovel, van...



Components:	60	Dimension	
Models:	6	(mm):	280x65x180
Item No.:	511 929	Vol (m ³):	0,0033
EAN:	4048962111262	Weight:	355 g



JUMBO STARTER

Lowboy with crane, airplane, tractor... many different models invite children to build and play. The large, easy-to-hold parts and assembly instructions written specifically for young children ensure quick construction success. Design work with this set develops important skills such as eye-hand coordination as well as gross and fine motor skills. A number of models can be built at the same time. For children from age 5.



Components:	135	Dimension	
Models:	16	(mm):	465x80x320
Item No.:	511 930	Vol (m ³):	0,0119
EAN:	4048962111279	Weight:	1185 g



CARTS



Components:	50	Dimension	
Models:	3	(mm):	225x65x150
Item No.:	505 279	Vol (m ³):	0,0022
EAN:	4048962069402	Weight:	220 g

BIKES



Components:	80	Dimension	
Models:	3	(mm):	225x65x150
Item No.:	505 278	Vol (m ³):	0,0022
EAN:	4048962069396	Weight:	210 g



CABLE CARS

Glide down the slope on a 6-meter long cable with the gondola clear up at the top and then with the freight elevator clear down to the bottom. Have fun!

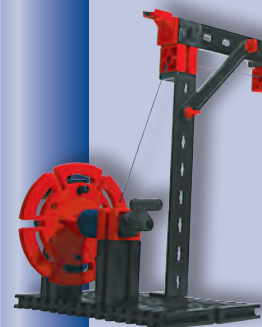

AIRCRAFT



Components:	100	Dimension	
Models:	3	(mm):	280x65x180
Item No.:	96 776	Vol (m ³):	0,0033
EAN:	4006209967768	Weight:	295 g

FUN CARS



Components:	85	Dimension	
Models:	3	(mm):	280x65x180
Item No.:	96 777	Vol (m ³):	0,0033
EAN:	4006209967775	Weight:	295 g

Components:	130	Dimension	
Models:	3	(mm):	330x80x235
Item No.:	41 859	Vol (m ³):	0,0062
EAN:	4006209418598	Weight:	605 g

ADVANCED 7+

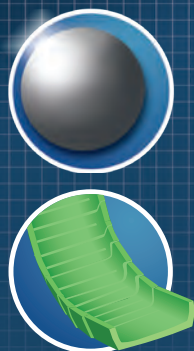

ROLLING ACTION

Balls race on the unique flex-rails through various obstacle courses. They can be accelerated and decelerated by a launching lever or the pretensioned catapult, cause chain reactions, shoot through loops and run over seesaws or are moved back up by an elevator with counter weight. The Rolling Action Set can be combined perfectly with the PROFI Dynamic Set.



- Incl. 11 flex-rails and 4 balls
- Incl. detailed, easy-to-understand assembly instructions

Components:	260	Dimension	
Models:	6	(mm):	465x80x320
Item No.:	516 183	Vol (m ³):	0,0119
EAN:	4048962136814	Weight:	1815 g



UNIVERSAL 3

40 models, such as vehicles with steering, bulldozer with tracks, crane with cable winch, windmill with reduction gear, allow children a fascinating glimpse into the world of technology while playing. The construction site and fair grounds play worlds with a number of models which can be built simultaneously guarantee a great deal of fun building and playing. The large number of parts leaves maximum leeway for creativity. A MUST for all fischer-technicians For children from age 7.

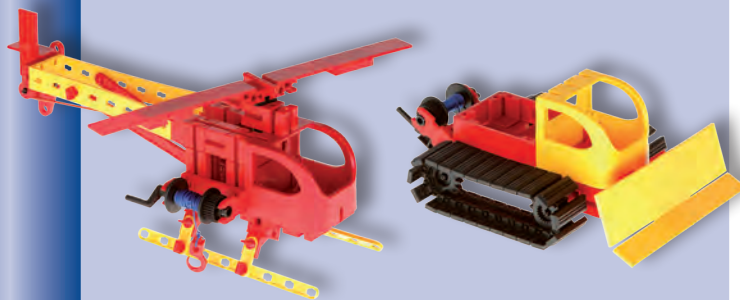

- Ideal additions (page 11):
Motor Set XS · Motor Set XM · Sound+Lights · Power Set

Components:	500	Dimension	
Models:	40	(mm):	465x80x320
Item No.:	511 931	Vol (m ³):	0,0119
EAN:	4048962111286	Weight:	1815 g



40
MODELS

Now you can get started. For the advanced in the fischertechnik group of technicians! The function is understandable with lots of details such as four-wheel steering and track chains that crawl over the terrain. Cranes that lift heavy loads. Merry-go-rounds that make

the figures fly and really robust in construction and for playing. With genuine functions and lots of attachment and expansion possibilities. Detailed assembly instructions lead to the finished models in logical steps.



XL BULLDOZER

Blocky tracked vehicles are cleaning up! This construction set offers four bulldozer types, which remain stable during play, with realistic details such as cable winch, dozer blade that can be raised and lowered and nonskid tracks. Mount up, let's go!

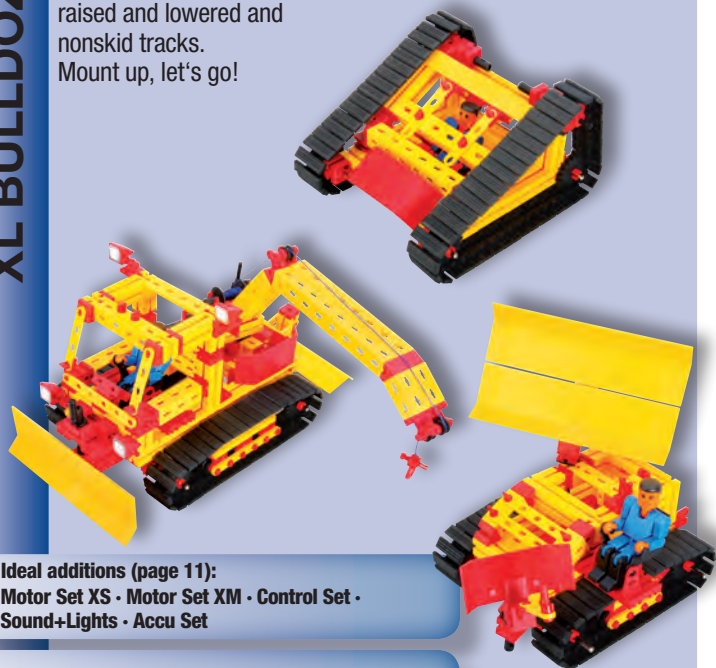

- Ideal additions (page 11):
Motor Set XS • Motor Set XM • Control Set • Sound+Lights • Accu Set

Components:	740	Dimension	
Models:	4	(mm):	465x80x320
Item No.:	505 280	Vol (m³):	0,0119
EAN:	4048962069419	Weight:	1490 g



FIRE TRUCKS

The six different fire trucks have operational fire extinguishing equipment. The extendable turntable ladder provides the capability to fight fires and conduct rescue at various heights. Here, fast help is guaranteed. The extendable outriggers secure the vehicle for difficult operations. Various models such as the airport fire department with a roof monitor or an implement truck can be assembled. A radio message from the headquarters — MOVE INTO ACTION!



- Ideal additions (page 11):
Motor Set XS • Motor Set XM • Control Set • Sound+Lights • Accu Set

Components:	430	Dimension	
Models:	6	(mm):	465x80x320
Item No.:	500 879	Vol (m³):	0,0119
EAN:	4048962003253	Weight:	1570 g

This line is a real challenge for real hobby inventors. With up to 780 parts and diverse functions, these constructions sets „Super Fun Park“ and ”Super Cranes“ do justice to their names.



SUPER FUN PARK

Complete construction set with motor and battery tray. With over 660 components, you can build a motorized Ferris wheel or a merry-go-round. The Ferris wheel has a diameter of over 50 cm and is equipped with six gondolas — a model that creates a real fair atmosphere.



- Incl. XS motor and battery tray for 9V block (battery not included)
- Ideal additions (page 11):
Sound+Lights • Power Set

Components:	660	Dimension	
Models:	3	(mm):	465x80x390
Item No.:	508 775	Vol (m³):	0,0145
EAN:	4048962095647	Weight:	1900 g

SUPER CRANES

Caution: Giants at work! More than one meter high and the boom is over a meter long, turns at the top or bottom and is built for really big loads! With traveling carriage and lifting tackle, mobile or stationary.



- Ideal additions (page 11):
Motor Set XS • Motor Set XM • Control Set •
Sound+Lights • Power Set

Components:	780	Dimension	
Models:	3	(mm):	465x80x390
Item No.:	41 862	Vol (m³):	0,0145
EAN:	4006209418628	Weight:	2280 g

MOTOR SET XS



Thanks to the compact measurements, this motor can be installed almost anywhere. In addition to the building blocks, gearbox parts and toothed gears, the set also contains a safety battery tray with integrated pole-reversing switch for nine volt block batteries (battery not included). Performance data: Voltage 9V ..., max. output 1.0 W at 6000 RPM.

Components: 45	Dimension (mm): 225x65x150
Item No.: 505 281	Vol (m³): 0,0022
EAN: 4048962069426	Weight: 200 g

SOUND+LIGHTS



If you want to breathe still more „life“ into the fischertechnik models using sounds and lights then the „Sound+Lights Set“ is the ideal solution! Up to three different sounds, which can be activated with push-buttons or automatically with digital inputs, can be placed on the sound module. Depending on the requirement, the sounds can be replaced very simply per USB. The blink connection, which is also included, allows the operation of up to eight indicator lights as blinking lights. The set contains a sound module with blink electronics, a USB cable, two indicator lights with various colored luminous caps and a battery tray for a nine volt block (battery not included). **Only Windows® compatible.**

Components: 30	Dimension (mm): 225x65x150
System: Windows®	Vol (m³): 0,0022
Item No.: 500 880	Weight: 270 g
EAN: 4048962003260	

ACCU SET



Charger, which is controlled by a microcontroller and provides reliable protection against overcharging. Very short charging time, max. two hours, powerful NiMH rechargeable battery pack with fuse for protection against a short circuit, 8.4V, 1500mAh.



Components: Charger + battery pack in one	Dimension (mm): 225x65x150
Item No.: 34 969	Vol (m³): 0,0022
EAN: 4006209349694	Weight: 880 g

MOTOR SET XM



High performance geared motor in compact plastic casing with numerous possibilities for attachments. With many toothed gears, axles and gearbox parts.

- Performance data: Voltage 9V ..., max. output 3.0 W about 340 RPM
- **Additionally required is Accu Set or Power Set**

Components: 40	Dimension (mm): 225x65x150
Item No.: 505 282	Vol (m³): 0,0022
EAN: 4048962069433	Weight: 275 g

CONTROL SET



The four channel infrared remote control allows you to control fischertechnik models from a distance as well. Up to three motors and one servo can be controlled proportionally. This means an infinitely variable turning angle of the steering wheel and infinitely variable speed control. Up to four receivers can be operated with the remote control, which allows numerous applications.

- **Additionally required is Accu Set**

Components: Controller, receiver, servo	Dimension (mm): 225x65x150
Item No.: 500 881	Vol (m³): 0,0022
EAN: 4048962003277	Weight: 370 g

POWER SET



Power pack and infinite Power Controller. The power supply from the electrical socket for all fischertechnik models.

- Power Pack Performance Data: Voltage 9V .../2,5 A.
- Power Controller Performance Data: Regulated output 1A max., additional output with 9V .../1 A max. (not regulated), both outputs short-circuit-proof with overload protection

Components: Power unit + control unit in one	Dimension (mm): 225x65x150
Item No.: 505 283	Vol (m³): 0,0022
EAN: 4048962069440	Weight: 425 g

CREATIVE BOX 1000



More than 700 components from the current fischertechnik assortment. Packed in BOX 1000 with building board 390 x 270 mm as cover.

Components: 720	Dimension (mm): 390x95x270
Item No.: 91 082	Vol (m³): 0,0100
EAN: 4006209910825	Weight: 2750 g

BOX 1000



Practical storage box with eight sorting boxes and 32 sorting partitions. The cover also serves as the big building board 390 x 270 mm.

Item No.: 30 383	Dimension (mm): 390x95x270
EAN: 4006209303832	Vol (m³): 0,0100
	Weight: 1830 g



12



CARS & DRIVES

How does a balloon drive or a bending rod drive work? What is the difference between a friction drive and a rubber-band drive. How can wind be used as a drive? This set provides a glimpse into how different types of drives work. The brawny offroad vehicle with functioning steering and suspension can also be combined perfectly with the Motor Set XM and Control Set for remote control. The instructional activity booklet provides a great deal of interesting information. For young engineers from age 9!

- Incl. instructional activity booklet
- Incl. friction motor
- **Ideal additions (page 11):**
Motor Set XM • Control Set • Sound+Lights • Accu Set

Components: 270	Dimension
Models: 8	(mm): 465x100x390
Item No.: 516 184	Vol (m ³): 0,0181
EAN: 4048962136821	Weight: 2150 g



PNEUMATIC 3

This play-and-learn construction set helps children learn the principles of pneumatics and uses realistic models to demonstrate how compressors, pneumatic valves and cylinders work. The new, powerful and compact compressor guarantees a reliable supply of compressed air to the models. In addition to vehicles such as front loaders, hay bale pickers and tree trunk grips, other educational models provide young inventors with background knowledge on the subject of pneumatics in combination with the instructional activity booklet.

- Incl. instructional activity booklet
- Incl. compressor, 4 pneumatic cylinders, four 4/3-way manual valves, battery holder for 9V block batteries (not including battery)
- **Ideal additions (page 11):**
Accu Set

Components: 360	Dimension
Models: 8	(mm): 465x80x320
Item No.: 516 185	Vol (m ³): 0,0119
EAN: 4048962136838	Weight: 1950 g

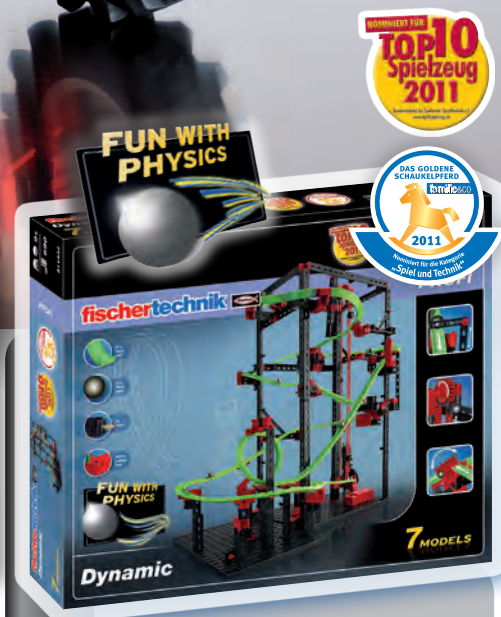

DYNAMIC

Fun with physics - Balls race on the unique flex-rails through various obstacle courses. They accelerate, decelerate, cause chain reactions, shoot through the loop and run through obstacles such as teeter-totters and switches. An elevator powered by an XS motor conveys the balls to the top. The effects are based on various physical phenomena (acceleration, inertia of mass, centrifugal force, law of conservation of energy, principle of linear momentum, laws of motion). These are explained in the activity booklet and can be demonstrated clearly using various experimental set-ups. Shows how entertaining physics can be!

- Incl. the didactic activity booklet.
- Incl. XS motor and battery tray for nine volt block (battery not included).

Components: 690	Dimension
Models: 7	(mm): 465x80x390
Item No.: 511 932	Vol (m ³): 0,0145
EAN: 4048962111293	Weight: 2655 g

Jump into the car, put it in gear and get going. But how does the technology work that allows us to use a low gear to go, slowly, but easily up a mountain or to fly down the mountain in a high gear? How does a kitchen appliance or a planetary gear work? Why don't

bridges collapse and why does a wobbly table become stable with four cross struts. These and other questions are answered in detail in the PROFI line.



OECO TECH

„Renewable energies“ will become our most important suppliers of energy in the future. The production, storage and use of electricity from natural energy sources such as water, wind and the sun are graphically illustrated using various models and numerous experiments. This is the way to create an understanding of the future energy forms. The hydro cell kit offers an ideal addition. With this expansion construction set, you can build several models and operate them with a fuel cell.



- Incl. the didactic activity booklet, „Renewable Energies“
- Incl. solar motor, solar module (1.2 V; 440 mA) and Gold Cap energy storage unit.

Components:	320	Dimension	
Models:	10	(mm):	465x80x320
Item No.:	505 284	Vol (m³):	0,0119
EAN:	4048962069457	Weight:	1710 g

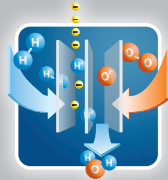

HYDRO CELL KIT

How does a fuel cell work? How can you produce hydrogen with it? This construction set provides knowledge for all areas associated with this exciting topic. With the fuel cell and the additional solar module, interesting additional models can be built in connection with the construction set, „Oeco Tech“. The didactic activity booklet offers assistance. All of your questions are answered.

(NOTE: The OecoTech item No. 505 284 is absolutely required for operation.)



- Incl. the didactic activity booklet, „Energy from Hydrogen“
- Incl. reversible fuel cell with integrated hydrogen storage unit, solar module (1.2 V; 440 mA)

Components:	20	Dimension	
Models:	6	(mm):	225x65x150
Item No.:	505 285	Vol (m³):	0,0022
EAN:	4048962069464	Weight:	530 g



E-TECH

Electrical circuits, electromechanics and electronic controls. Using functional models, for example, the principle of series and parallel connections and the control of a traffic light are explained step by step. For this purpose, the „E-Tech Modul“ (see above) with eight set programs that control, for example, a burglar alarm with a buzzer, a hand dryer with a light barrier or a garage door with a magnetic sensor and these devices are controlled through three inputs for digital sensors such as a probe, photo-transistor and reed contact and an output for a motor or two indicator lights.



- Incl. the instructional activity booklet „Electrical Technology“
- Incl. Mini Motor, E-Tech Modul, sensor, lightbarrier, magnetic sensor and buzzer, battery tray for nine volt block (battery not included).

Components:	260	Dimension	
Models:	12	(mm):	465x80x320
Item No.:	91 083	Vol (m³):	0,0119
EAN:	4006209910832	Weight:	1710 g

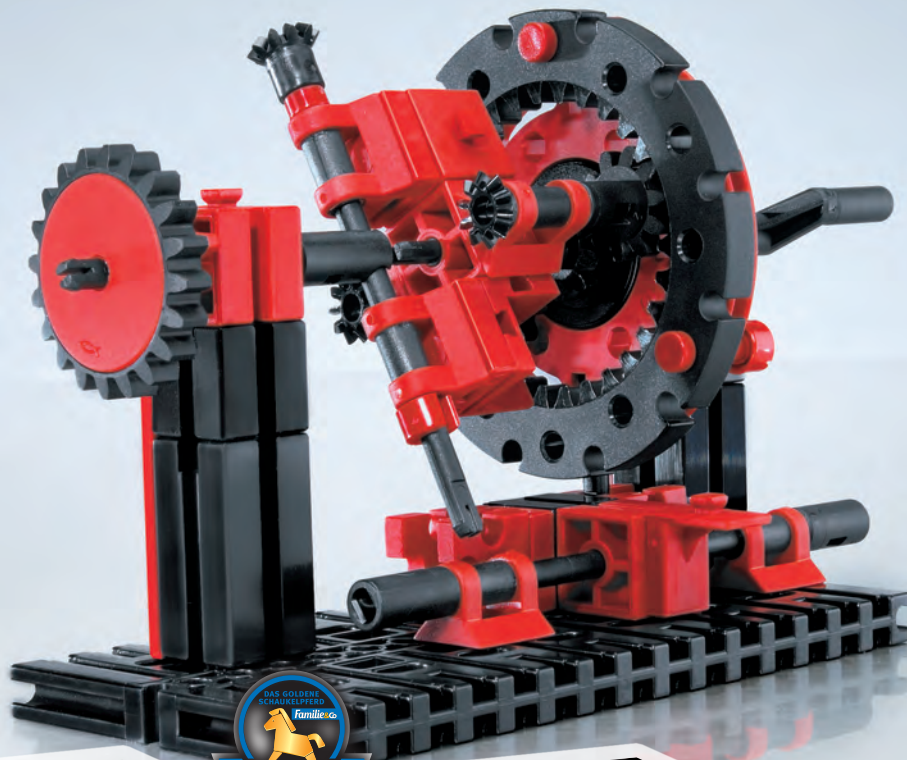

14



DA VINCI MACHINES

This construction set combines several mechanical models, whose origin goes back to designs from Leonardo da Vinci: file cutting machine, pivoting bridge and chariot. An activity booklet with numerous illustrations and descriptions for the original designs from Leonardo da Vinci provides information, which is worth learning. History you can touch!



- Incl. the didactic activity booklet „Machines from Leonardo da Vinci“

Components:	260	Dimension	
Models:	10	(mm):	465x80x320
Item No.:	500 882	Vol (m ³):	0,0119
EAN:	4048962003284	Weight:	1540 g



TECHNICAL REVOLUTIONS

On the trail of James Watt, Michael Faraday and other famous inventors. The construction set brings new life to important moments of technology history. Important technological inventions can be reproduced as functional models, for example, an electric motor, cardan shaft, a Morse telegraph and a generator. The didactic activity booklet provides additional background information. For little creative tinkerers and inventors starting with nine years old.



- Incl. the didactic activity booklet
- Incl. XS motor and battery tray for nine volt block (battery not included)

Components:	270	Dimension	
Models:	12	(mm):	465x80x320
Item No.:	508 776	Vol (m ³):	0,0119
EAN:	4048962095654	Weight:	1580 g



MECHANIC+STATIC

The ultimate technology construction set for all future mechanical engineers, technicians and engineers: How does a gear box work? What is a planetary gear? How is the movement of a windshield wiper produced? How do you design a stable bridge? The answers to these and other elementary questions from the subject areas of mechanics and statics are found in this construction set with 30 different models.



- Incl. the didactic activity booklet „Mechanic+Static“
- Incl. Mini Motor and battery tray for nine volt block (battery not included)

Components:	500	Dimension	
Models:	30	(mm):	465x100x390
Item No.:	93 291	Vol (m ³):	0,0181
EAN:	4006209932919	Weight:	2150 g

included:



Software
ROBO Pro Light



ROBO LT Controller



ROBO LT BEGINNER LAB

The complete beginner's packet for kids starting with eight years old. Using over 200 components and with the help of sensors (phototransistor, push-button switch) and the actuators (XS motor, indicator lights), children can construct eight easy to understand models such as a lighthouse with a blinking light, a merry-go-round or an automatic sliding door. The control ROBO LT Controller with three inputs for sensors and two outputs for motors or indicator lights has a USB interface. The software ROBO Pro Light allows quick and childishly easy programming. The detailed didactic activity booklet supports the learning process for children and explains the programming in a way, which is easy to understand. For tomorrow's engineers. Incl. battery tray for nine volt block (battery not included).

- Incl. the didactic activity booklet
- Incl. ROBO LT Controller as control (USB interface)
- Incl. control software ROBO Pro Light
- Incl. XS motor, 2 indicator lights, phototransistor and push-button switch
- **Ideal additions (page 11): Accu Set - Power Set**

Components:	200	Dimension	
Models:	8	(mm):	465x80x320
Item No.:	508 777	Vol (m³):	0,0119
EAN:	4048962095661	Weight:	1760 g

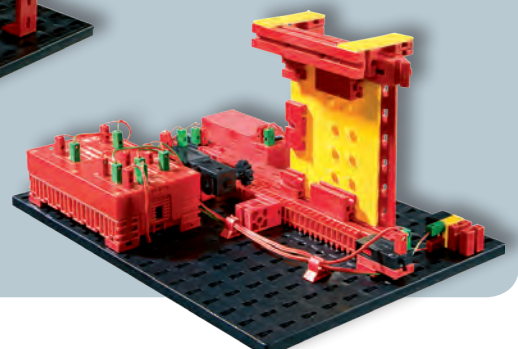
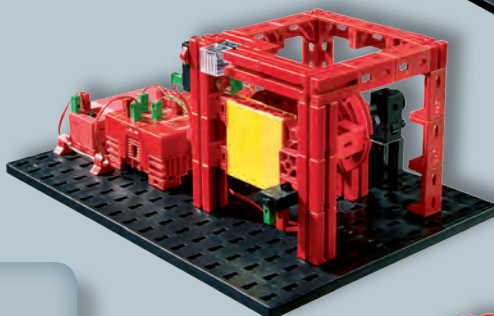

included:



Software ROBO Pro



ROBO TX Controller



Encoder motor for exact positioning



ROBO TX TRAINING LAB

COMPUTING beginner construction set with everything you need for this: Consisting of 310 components for the building of six mobile robot models, for example, driverless transport system, obstacle detector and trail searcher etc., two encoder motors for exact positioning, „Motor XS“, infrared trail sensor, two sensing devices. It also Incl. the new compact and powerful „ROBO TX Controller“ with Bluetooth radio interface, 32-bit processor (200 MHz), eight universal inputs and 8 MB RAM (2 MB flash), including software „ROBO Pro“ for programming. The extensive accessories provide many possibilities for creativity.



- Incl. related instructional material on CD
- Incl. ROBO TX Controller, software ROBO Pro, 2 each encoder motors, Motor XS, infrared trail sensor, 2 each sensing devices
- Additionally required is Accu Set (page 11)

Components:	310	Dimension	
Models:	11	(mm):	465x80x320
Item No.:	505 286	Vol (m ³):	0,0119
EAN:	4048962069471	Weight:	1960 g

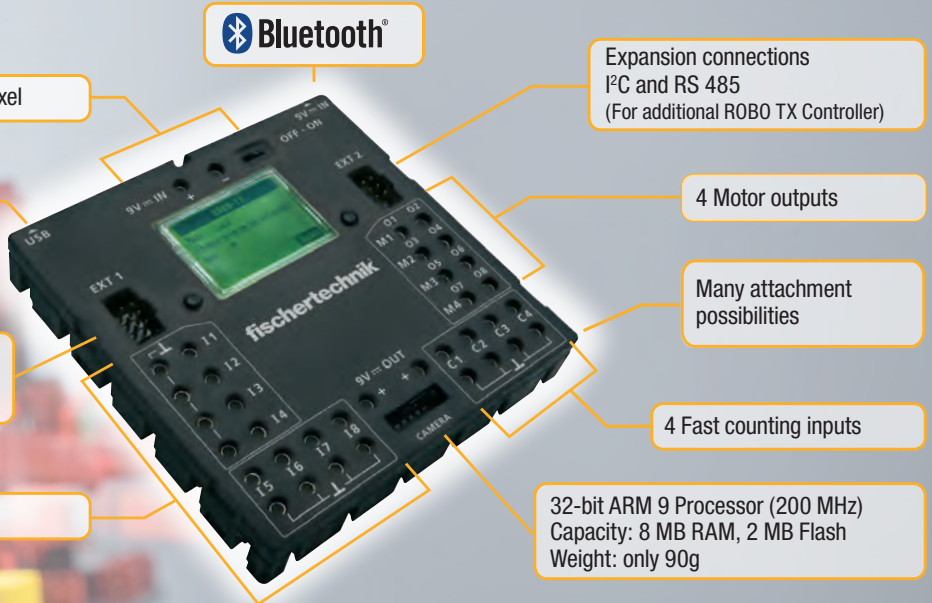

ROBO TX



ROBO PRO SOFTWARE

Simple entry for beginners through programming of flow charts consisting of various software building blocks. The exchange of the data between the software building blocks and the subprograms can be done through variables and graphical connections as well. This allows the program functions to be shown in an understandable manner. There are no problems with the preparation of teach-in programs or data exchange with other Windows® software.

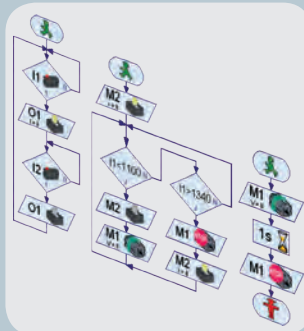

System:	Windows® XP, Vista, 7	Dimension	
Item No.:	93 296	(mm):	210x25x150
EAN:	4006209932964	Vol (m ³):	0,0008
		Weight:	105 g

ROBO TX CONTROLLER



The controller with 32-bit processor, display, high storage capacity and with compact casing (90x90x15mm) offers numerous attachment possibilities on five sides. With integrated Bluetooth radio interface (2.4 GHz, range about 10 m). Several „ROBO TX Controller“ can be coupled together.

- 32-bit ARM 9 processor (200 MHz)
- Storage capacity: 8 MB RAM, 2 MB flash
- Weight only 90g
- 8 Universal inputs: Digital, analog 0-9V DC, analog 0-5kΩ
- 4 fast counting inputs: Digital, frequency up to 1kHz
- 4 motor outputs, 9V, 250mA: Speed infinitely variable, short circuit proof, alternatively
- 8 individual outputs
- 2 expansion connections: I2C and RS 485 for coupling of additional „ROBOTX Controller“
- Display: 128x64 pixel, monochrome
- USB interface: USB 2.0 (1.1 compatible), max. 12 MB, including mini-USB socket connector
- Programmable with „ROBO Pro“ or C compiler (not included)

- Incl. USB connection cable
- Additionally required is Accu Set or Power Set (page 11)

Item No.:	500 995	Dimension	
EAN:	4048962003826	(mm):	225x65x150
		Vol (m ³):	0,0022
		Weight:	460 g



Construct machines and robot models, program the control software on the PC and put the whole thing into motion. You need a commercially available PC with the Windows® operating system, (starting with Win XP or later), the easy-to-use graphic fischertech-

nik software „ROBO Pro“ to program the commands that the robot is to carry out and in addition the „ROBO TX controller.“ This converts the computer commands into control signals for the motors.

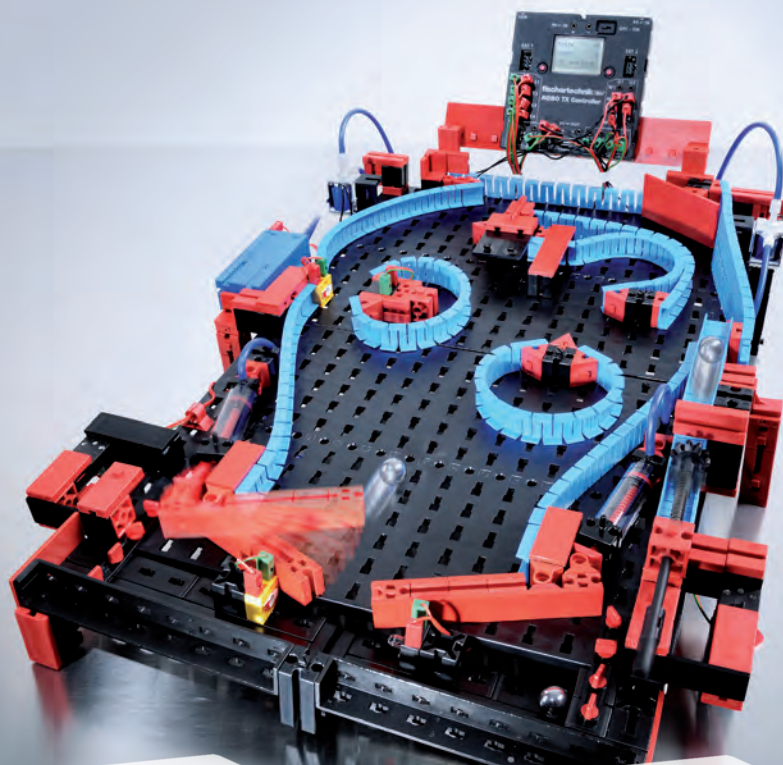

NEW



ROBO TX ELECTROPNEUMATIC

The subjects of electro-pneumatics and vacuum technology are demonstrated clearly with the aid of fascinating models such as the pneumatic motor, color sorting robot for colored parts, ball obstacle course and pinball machine. The new, powerful and compact compressor guarantees a reliable supply of compressed air to the models. The electro-magnetic valves included allow remote control of the models with a PC.

- Incl. related instructional material on CD
- Incl. compressor, miniature motor, 2x solenoid valves, optical color sensor, vacuum exhauster, 3x cylinders with spring, 2x photo-transistors, 2x lens tip lamps, 11 flex-rails
- Additionally required is ROBO TX Controller, Software ROBO Pro (page 16); Accu Set or Power Set (page 11)

Components:	400	Dimension	
Models:	4	(mm):	465x80x320
Item No.:	516 186	Vol (m³):	0,0119
EAN:	4048962136845	Weight:	2150 g



ROBO TX AUTOMATION ROBOTS

Four reality-based and fully functional industrial robots: High-rack storage, 3-axis robot and 2 other grappler robots. Sturdy fischertechnik aluminum channels used in all models. The instructional activity booklet provides support in the form of background information, projects and programming tips. For programmers and designers from age 10.

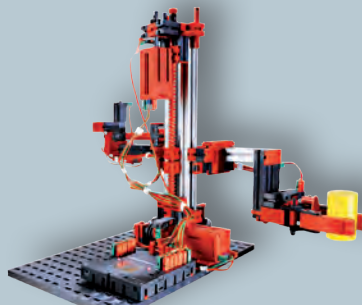

- Including didactic activity booklet on CD
- Incl. assembly instruction booklet
- Incl. 2x »Encoder Motors«, 2x »XS Motors«, 6x Sensors
- Additionally required is ROBO TX Controller, Software ROBO Pro (page 16); Accu Set or Power Set (page 11)

Components:	510	Dimension	
Models:	4	(mm):	465x80x320
Item No.:	511 933	Vol (m³):	0,0119
EAN:	4048962111309	Weight:	2235 g



ROBO TX EXPLORER

Explore unknown areas, measure distances, follow trails, show driving directions by means of blinking signals, recognize colors, measure temperatures, avoid obstacles without touching them, recognize day and night, turn headlights on and off automatically and trigger an alarm etc. The ROBO TX Explorer sensors can do all of this and lots more: The NTC resistor, the photoresistor, the ultrasonic distance sensor, the infrared color sensor and the specially developed trail sensor. Thanks to two encoder motors, the tracks can be controlled precisely and steered synchronically. With the rescue robot, which is contained as a model, the construction set provides the ideal basis for participation in the RoboCup.

- Incl. the didactic activity booklet
- Incl. 2x encoder motors, 3x indicator lights, buzzer, NTC resistor, photoresistor, ultrasonic distance sensor, optical color sensor and an IR trail sensor
- Additionally required is ROBO TX Controller, Software ROBO Pro (page 16); Accu Set (page 11)

Components:	400	Dimension	
Models:	6	(mm):	465x80x320
Item No.:	508 778	Vol (m³):	0,0119
EAN:	4048962095678	Weight:	1570 g

Sales Promotion



End consumer brochure
item No. 39 090



Brochure holder
item No. 120 949



Shopping bag, 46x59 cm
item No. 43 355

fischertechnik 

Top sign 125x30 cm – item No. 39 917
100x30 cm – item No. 47 227

Informative and exciting POS video that boosts sales
(On request)



Decorative model wind-mill with light and solar module, 26x20x52 cm
item No. 503 546

Luminous logo, 125x20 cm – item No. 50 460



Banner, 200x80 cm
item No. 500 887



Shelf strips, 125x3,5 cm – item No. 39 911

We support your sales with highly effective and attention-getting measures and aids so that you can achieve the optimal presentation at the point of sale (POS) and in the display window for the best-possible attraction of the end consumer.



Decoration cube, 25x25x25 cm
item No. 142 202



Poster »ADVANCED«, DIN A1
item No. 39 125



Poster »COMPUTING«, DIN A1
item No. 39 126

Play box – item No. 41 682

The play box allows the little designers to experience the fischartechnik world in a realistic and gripping way. With the many components and instructions, the play box provides optimal support for your events. The nice thing about it is that you can use it again and again.



Show window decoration package (On request):

- Decoration model windmill
- Decoration cube
- Banner
- Empty packages
- Assembly instructions
- Individual parts



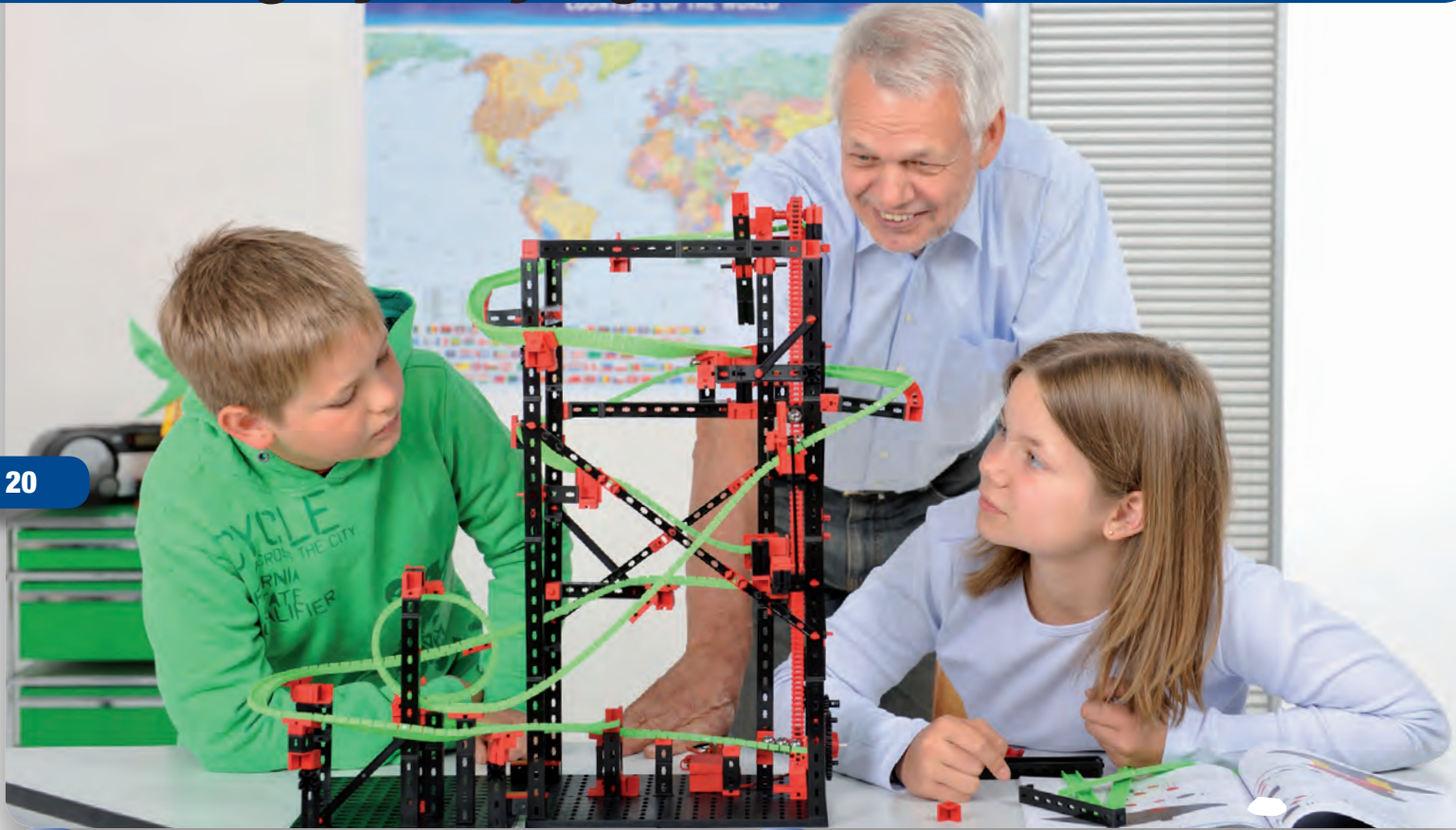

The construction sets from fischertechnik

- ... promote eye and hand coordination;
- ... promote gross and fine motor functions;
- ... promote the spatial powers of imagination;
- ... promote fantasy and creativity;
- ... promote logical thought and
- ... provide basic technical understanding.

The products from fischertechnik are learning toys „made in Germany“ and are produced at the location in Salztetten in the Black Forest. All construction sets can be ideally combined with one another. The high acceptance by parents, teachers and engineers makes fischertechnik a successful educational material for schools and universities.

The Awards



FAN CLUB

More than 30,000 fans are members at no cost in the fischertechnik Fan Club. Every fan regularly receives current information and has his personal member identification. In this way, we guarantee that important information such as information about new items reaches our target group quickly.

Fan Club Day

On Fan Club Day, fischertechnik opens its gates to the Fan Club members. The fans receive the exclusive opportunity to take a peek behind the curtains of the traditional brand. This creates trust in the quality of the products. The little visitors receive information about new products and can participate in COMPUTING workshops. Join-in activities and prize games are particularly interesting for the kids. Customer relations at the highest level!



21

The Fan Club at www

In the model gallery, fans publish pictures of their models. Other fans vote on these model suggestions and select the winner for the quarter. So others catch the fischertechnik fever this way!

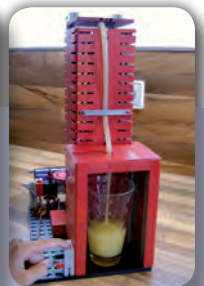
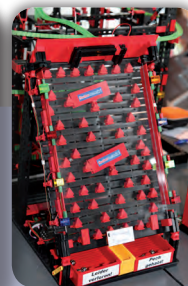

Fan Club NEWS

The NEWS appears two times a year and offers the readers a lot of current information about the products, new items and technology. For the little fans, there is a puzzle page and in each edition the Fan Club model with assembly instructions. These assembly instructions are only found in the NEWS. This allows our customers to always be up-to-date!



„We would be happy to develop an opportunity especially for you as a dealer to present yourself in this environment. Just get in touch with us!“

fischertechnik for teaching

How does a gear box work? What is a planetary gear? How is the movement of a windshield wiper produced? These are questions, which our instructional activity booklets illustrate and are explained in a way that is easy to understand. This starts with elementary subjects such as mechanics, statics, electronics and information science etc. and progresses to the practical implementation, which can be understood quickly, of everyday technical devices such as traffic lights, fans and a lifting tackle and then moves on to the technically refined and demanding solutions for robotics and computing.

Additional worksheets can be downloaded from the fischertechnik Web site and with the thematically developed questions and answers, these are an additional instrument to provide understanding of the corresponding instruction in a simple and precise manner and to test the learning success.

In addition, there is the very practical and systematically constructed storage system where each part has its place and is quickly found and helps with the daily didactic work (available separately).

The instructional construction sets from fischertechnik are specially designed for use in technical instruction and in technical facilities for the basic and secondary level. Here, there are the following topics: Mechanics, statics, electrical technology, regenerative energies and measuring, controlling and regulating (information science, mechatronics and computing). This is supported by books, instructional activity booklets and worksheets. For this purpose, there are intelligent storage systems that provide order and reliability for the everyday things at school.

Additional information is available at:
www.fischertechnik.de

The grid displays various instructional materials for the ROBO TX Training Lab. It includes:

- Assembly instructions:** A large diagram showing the assembly of a robot with a motor, gears, and a camera.
- Activity booklet:** A page with a table of contents and detailed text instructions for building the robot.
- Worksheets:** Three pages titled 'Einführung Aktoren' (Introduction Actuators), 'Sensoren' (Sensors), and 'Computer Starter' (Computer Starter), each with diagrams and text.
- Sorting suggestion:** A page with a grid of small images of parts, each labeled with a number and a letter, to help identify components.

Well-thought-out storage



For training and in-service training

Training models

Compact function models, which are already assembled, provide ideal training and demonstration models for training and in-service training and industrial automation. Available in the 9V standard voltage and in the worldwide 24V industrial standard.

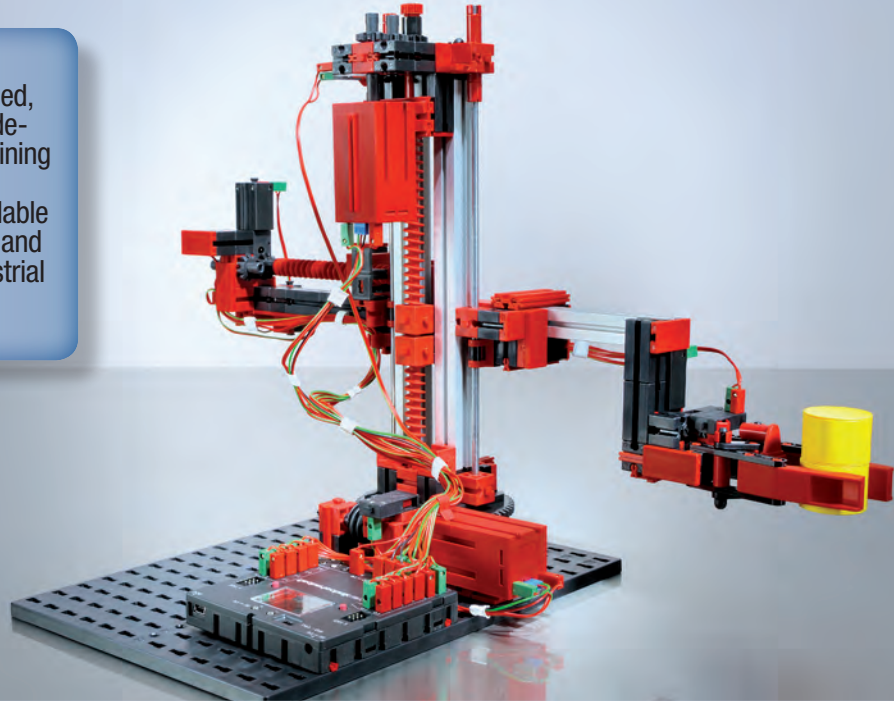

23

Plan+Simulation

The function models from fischertechnik, Plan+Simulation, are a proven and inexpensive means to plan and to develop industrial controls with the associated software and to test processes. They are employed worldwide in the areas of training, development and presentation.

The flexibility and the modularity of the fischertechnik system in connection with the industrially adapted sensors and actors as well as the controls from leading manufacturers open up almost unlimited possibilities for hardware simulation. Complicated technical systems are presented realistically and thus perfectly simulated so that they are understandable for everyone. This makes investment decisions easier and reduces the costs for the correction of planning mistakes.

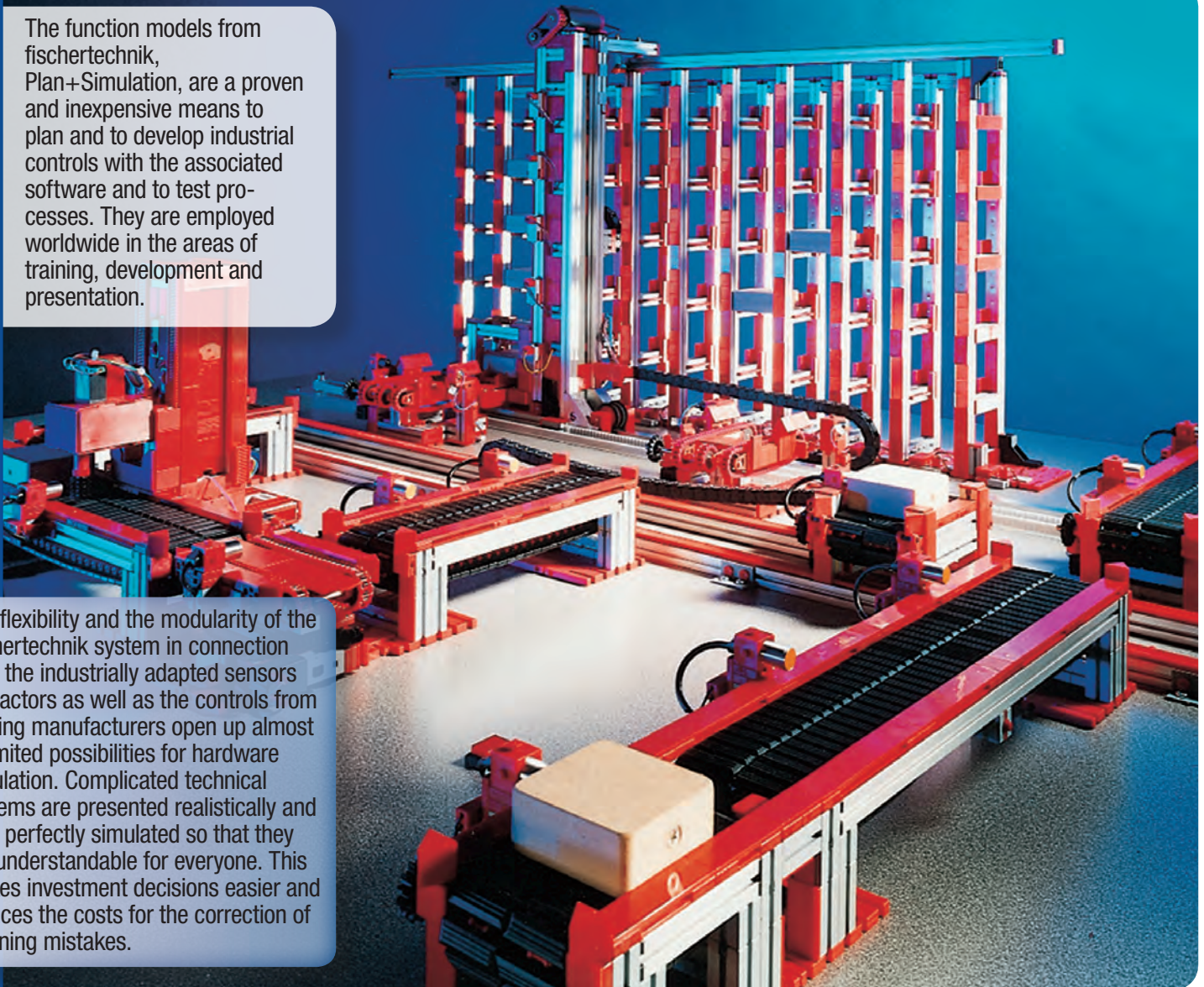



WHAT DO YOU GET FROM THIS AS A TOY DEALER?

A uniform system with design construction sets at the highest level and the best quality as well the strong fischertechnik brand as a reference for your pedagogical and valuable range of toy products. Over 30,000 fan club members, optimal support and a well-founded assortment system and diverse additional products serve to promote your sales throughout the year.

WHAT DO CHILDREN GET FROM THIS?

Only the best and they can play and play and play. Creative and concentrated when building models and then fun with role playing with each other.

WHAT DO PARENTS GET FROM THIS?

The certainty that their child can playfully enter the world of technology and understand and learn about it. The independent construction of continually new fischertechnik models promotes logical thinking and creativity. Thus, you are supporting the natural talent of your children to grasp technology in the truest sense of the word. The fischertechnik world of your children is boundless because all construction sets fit ideally together and supplement each other.

fischertechnik 

fischertechnik GmbH
Weinhalde 14-18, D-72178 Waldachtal
Phone +49 74 43/12-48 64, Fax +49 74 43/12-45 91
E-mail: info@fischertechnik.de

www.fischertechnik.de

The right to errors and technical and assortment changes is reserved. Liability for printing errors and deficiencies is excluded. Catalogue not valid for the USA.

fischer 
innovative solutions

World of fischer

Befestigungssysteme
 Automotive Systems
 Prozessberatung
 fischertechnik

