

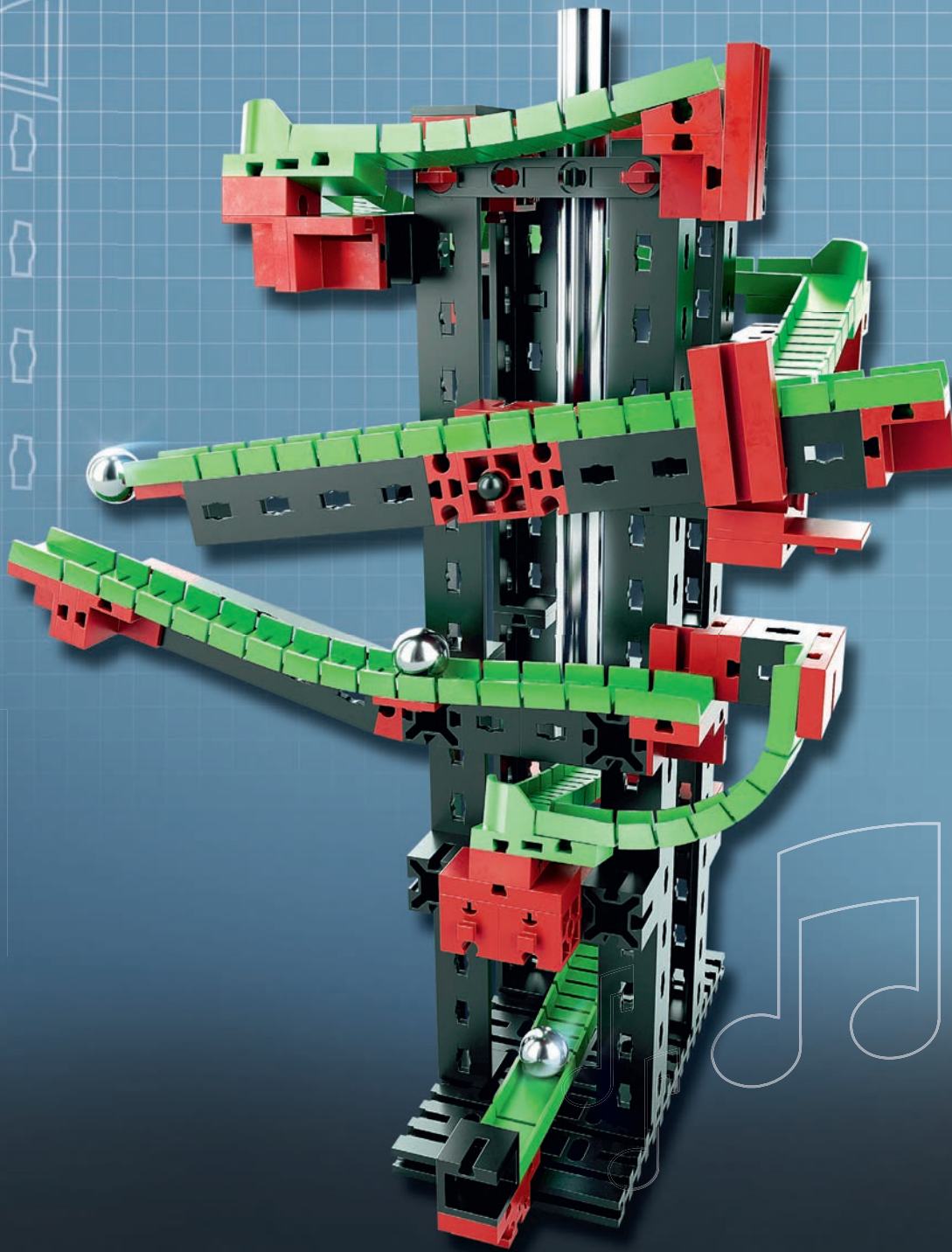

fischertechnik 

PROFI



Dynamic S

3 MODELS

Inhalt
Contents
Contenu

Inhoud
Contenido
Conteúdo

Contenuto
Содержание
目录

Einzelteilübersicht / Spare parts list / Liste des pièces détachées / Onderdelenoverzicht / Lista da piezas / Resumo de peça individual /
Singoli componenti / Перечень деталей / 零件概览 1

Montagetipps / Tips for assembly / Tuyaux pour le montage / Montagetips / Consejos para el montaje / "Dicas" para montagem /
Consigli per il montaggio / Советы по сборке / 装配建议 1

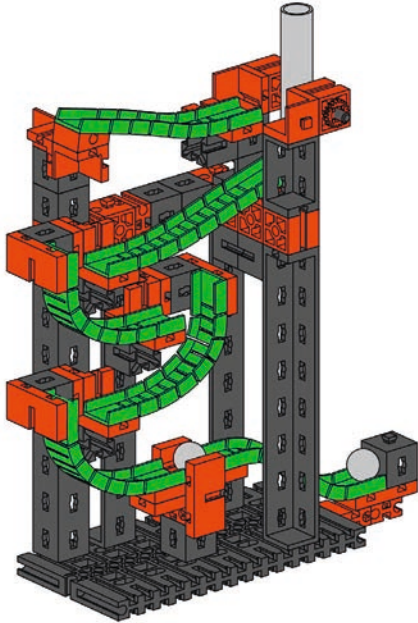

Einfacher Parcours / Simple obstacle course / Simple parcours /
Eenvoudig parcours / Pista de recorrido simple / Circuito fácil /
Circuito facile / Простая трасса / 简单的滚珠弯道 2

Parcours mit zwei Bahnkreisläufen / Obstacle course with twin tracks /
Parcours avec deux trajectoires en circuit / Parcours met twee omlopen /
Pista de recorrido con dos circuitos / Circuito com dois conjuntos de
trilhos de trem / Circuito a due piste / Трасса с двумя
маршрутами / 具有两条通道的滚珠弯道 6

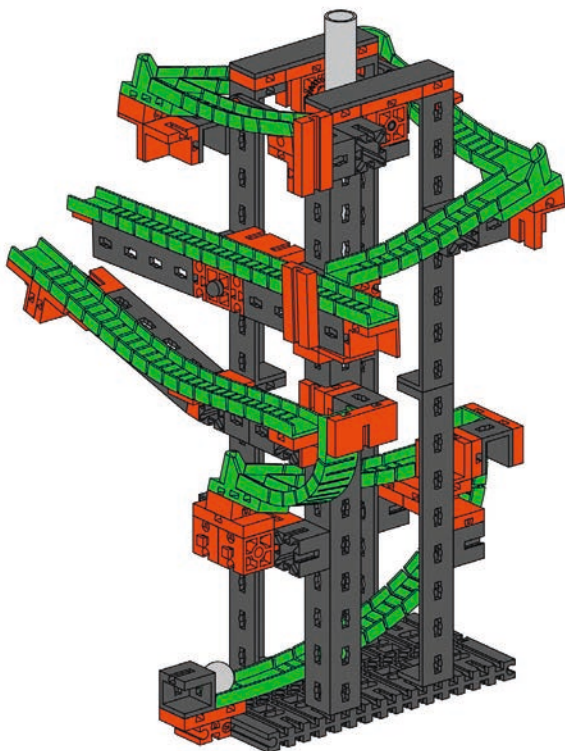
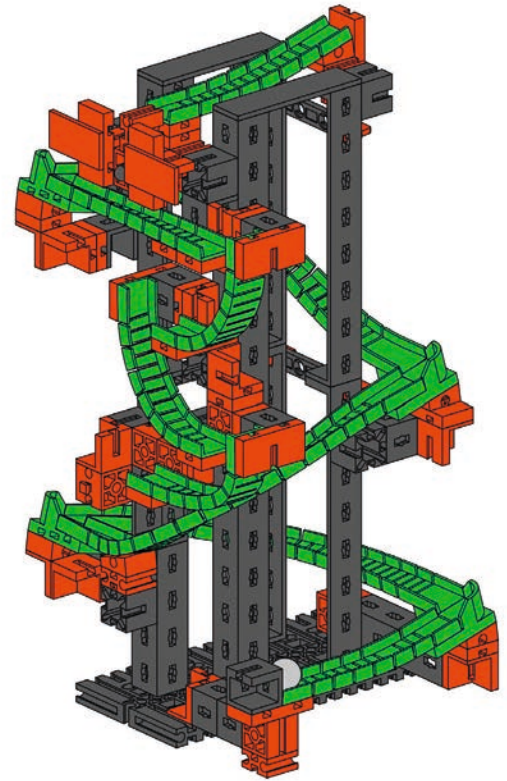









Action-Parcours / Action obstacle course / Parcours d'activités /
Action-parcours / Pista de recorrido de acción / Circuito de ação / Circuito
azione / Активная трасса / 复杂的滚珠弯道 13

Einzelteilübersicht
Spare parts list
Liste des pièces détachées



	31 597 2 x
	31 981 6 x
	31 982 12 x
	32 064 8 x
	32 850 12 x
	32 870 1 x
	35 049 6 x
	35 129 1 x

Onderdelenoverzicht
Lista da piezas
Resumo de peça individual

	36 293 8 x
	36 323 4 x
	36 334 3 x
	36 913 2 x
	36 920 1 x
	36 921 2 x
	36 922 5 x
	36 950 6 x

	37 237 8 x
	37 468 6 x
	38 240 16 x
	38 241 2 x
	38 416 1 x
	38 423 1 x
	38 428 9 x
	133 008 2 x

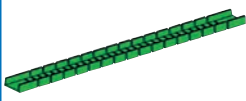
Singoli componenti
Перечень деталей
零件概览

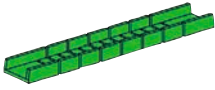
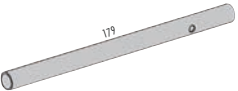
	143 234 3 x
	144 262 3 x
	151 715 4 x
	155 901 6 x
	155 959 1 x

Montagetipp
Tips for assembly
Tuyaux pour le montage

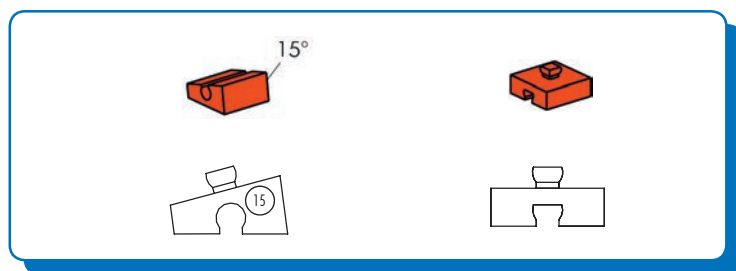

Montagetipp
Consejos para el montaje
"Dicas" para montagem

Consigli per il montaggio
Советы по сборке
装配建议

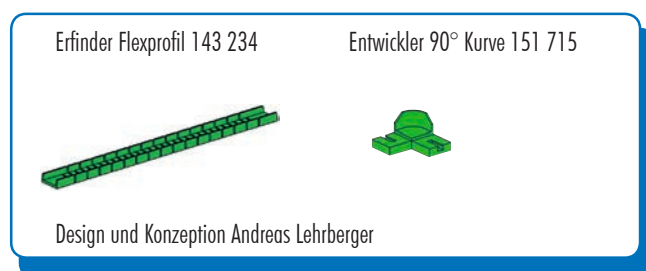





Sicherheitshinweise
Safety Information
Consignes de sécurité

Veiligheidsrichtlijnen
Indicaciones de seguridad
Observações sobre segurança

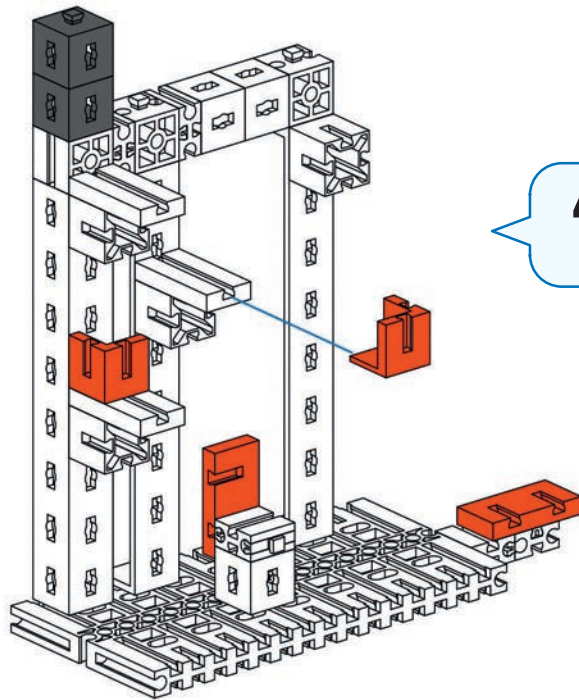

Informazioni per la sicurezza
Указания по технике безопасности
安全指南

- Alle Einzelteile, insbesondere bewegliche Teile sind falls notwendig zu warten und zu reinigen.
- All components, especially moving parts, should be maintained and cleaned as necessary.
- Toutes les pièces détachées et en particulier les pièces mobiles, sont, si nécessaire, à entretenir et à nettoyer.
- Alle onderdelen, vooral de bewegende delen, kunnen, indien noodzakelijk, onderhouden en gereinigd worden.
- Es necesario limpiar y mantener en buen estado todas las diferentes piezas - especialmente las piezas móviles.
- Caso necessário, todas as peças individuais, especialmente peças móveis, tem que ser submetidas à manutenção e ser limpadas.
- Se necessario, tutti i singoli componenti, soprattutto le parti mobili, si devono eventualmente sottoporre a manutenzione e pulizia.
- Все детали, особенно подвижные, требуют ухода и чистки.
- 必要时应保养和清洁所有零件，尤指运动部件。

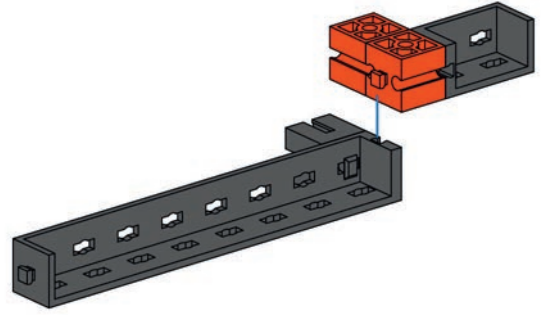

- 4**  2x  2x  2x

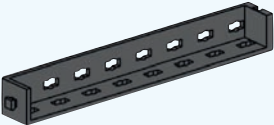
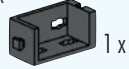

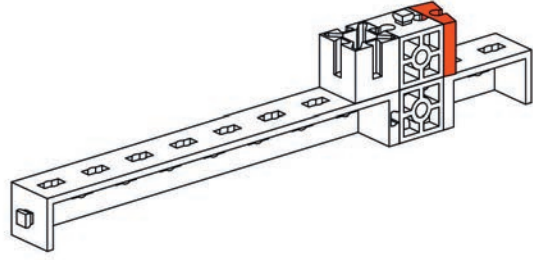

- 5**  1x  1x  1x  2x

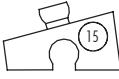

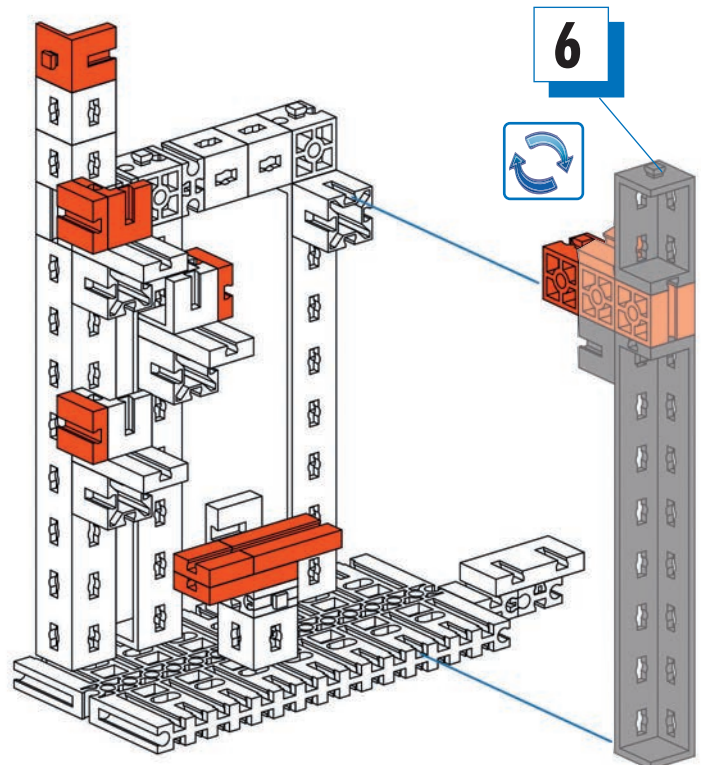
- 6**  1x  15

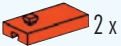

- 7**  1x  2x  4x  2x

8



4x



1x

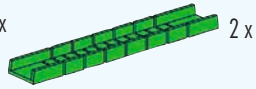

2x

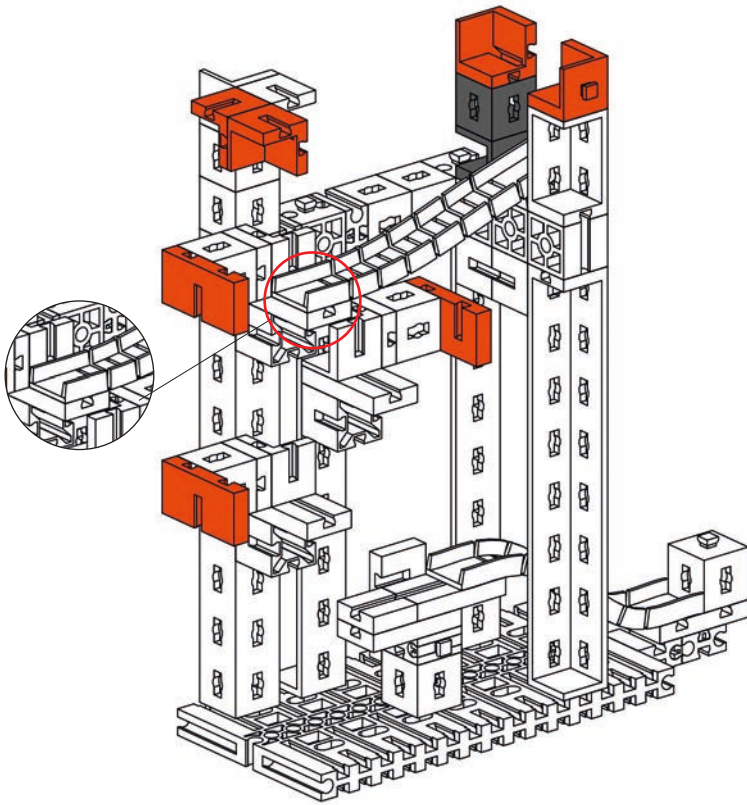
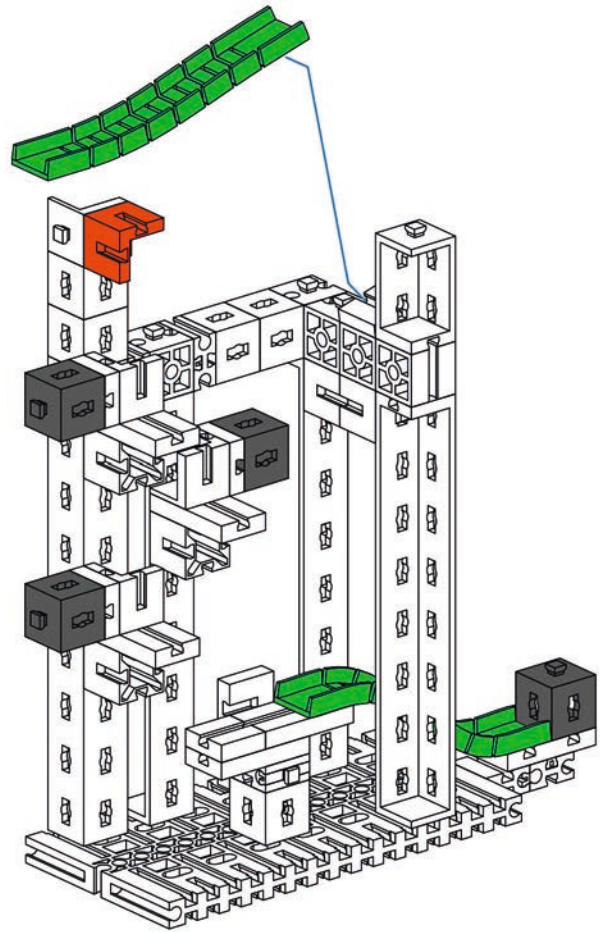

9



4x



3x



2x

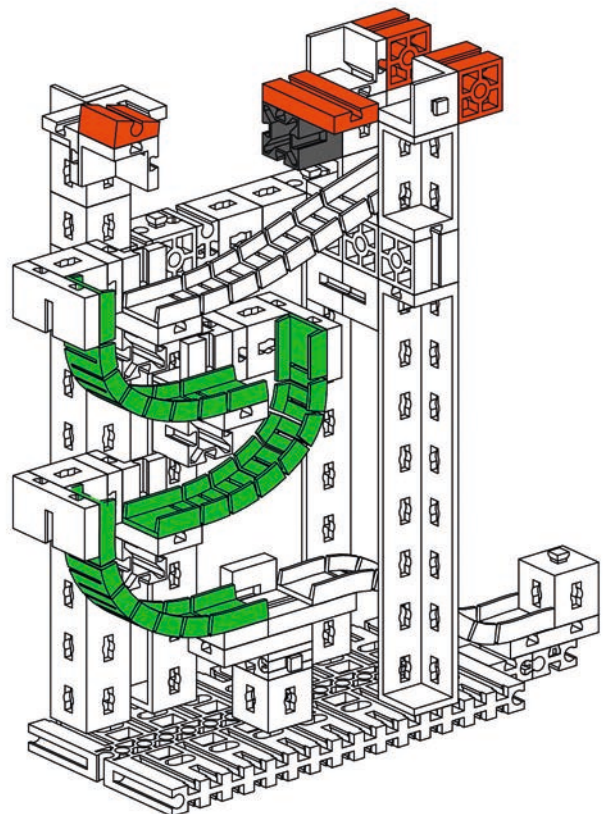

10

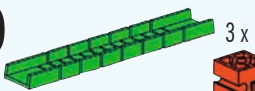

3x

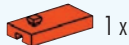

1x



1x



2x



1x

15°



15

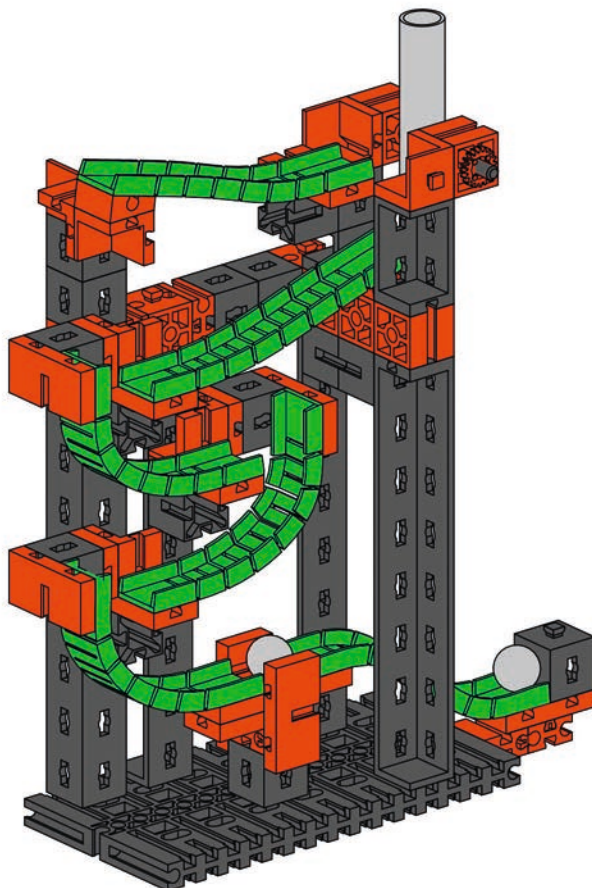
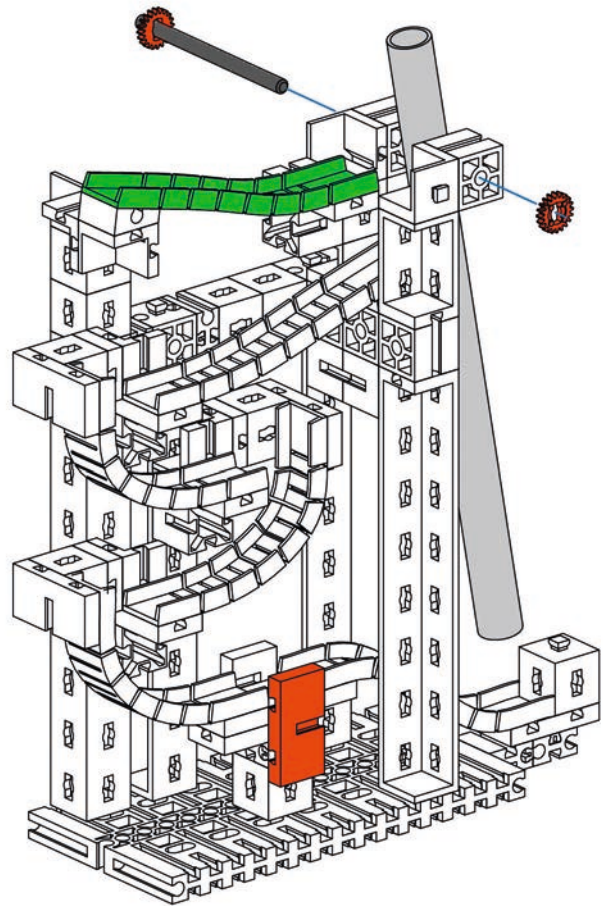
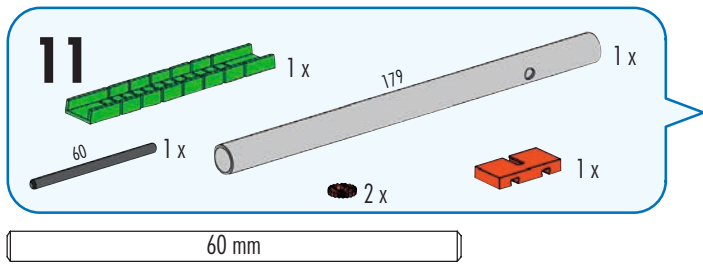

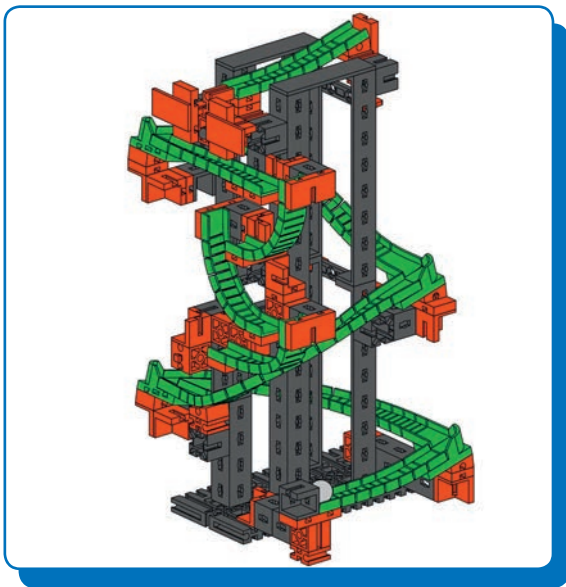

Parcours mit zwei Bahnkreisläufen
Obstacle course with twin tracks
Parcours avec deux trajectoires en circuit

Parcours met twee omlopen
Pista de recorrido con dos circuitos
Circuito com dois conjuntos de trilhos de trem

Circuito a due piste
Трасса с двумя маршрутами
具有两条通道的滚珠弯道

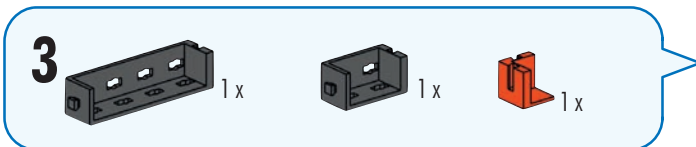
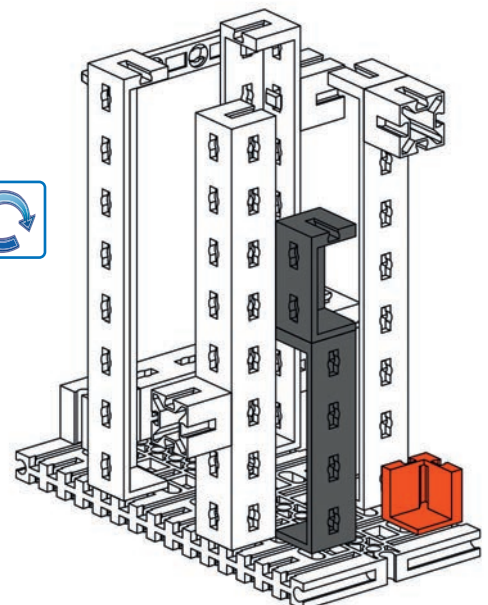
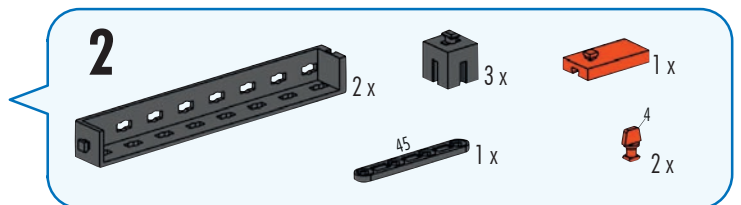
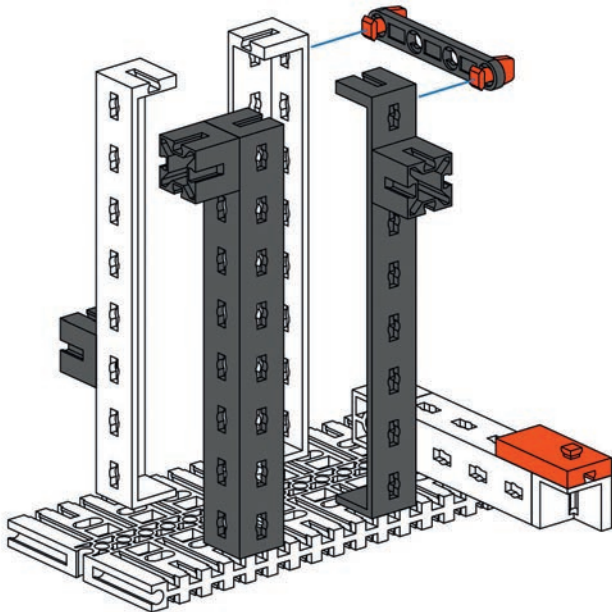
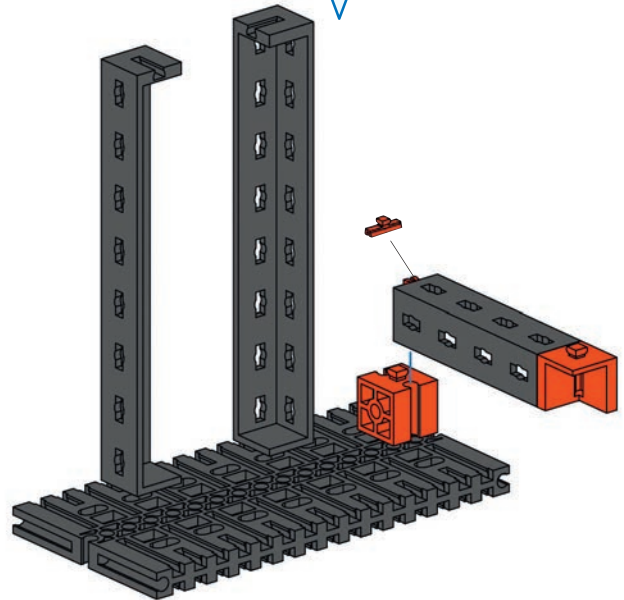
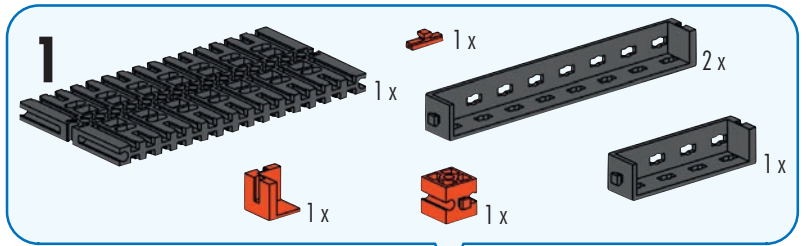

4

- 1 x
- 2 x
- 3 x

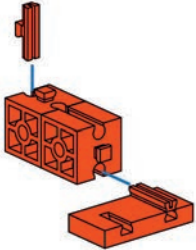
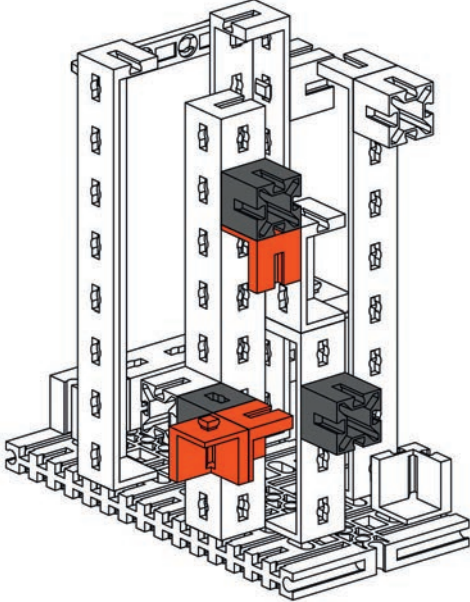

5

- 2 x
- 2 x
- 1 x

5

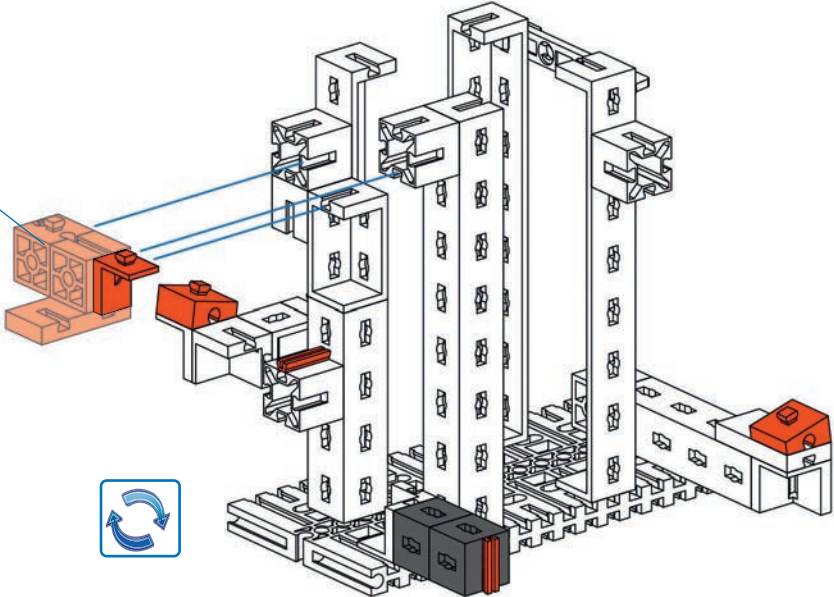

6

- 1 x
- 2 x
- 2 x
- 2 x

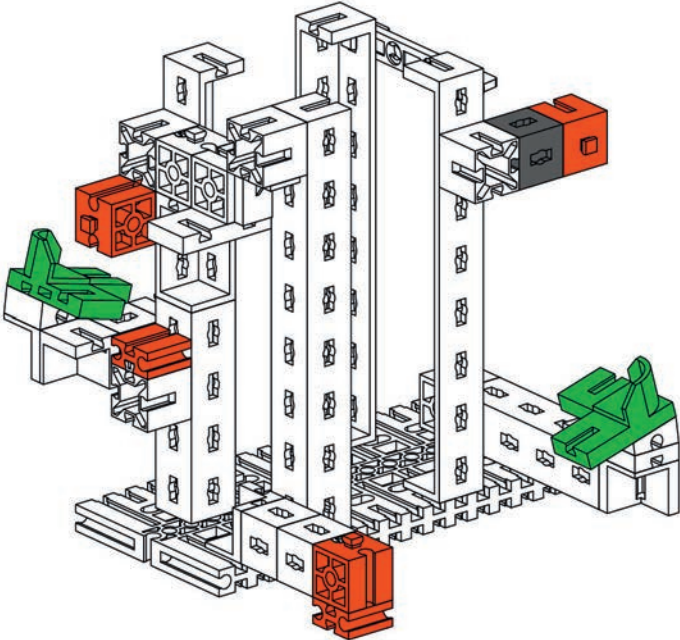

7

- 2 x
- 2 x
- 2 x
- 1 x
- 1 x

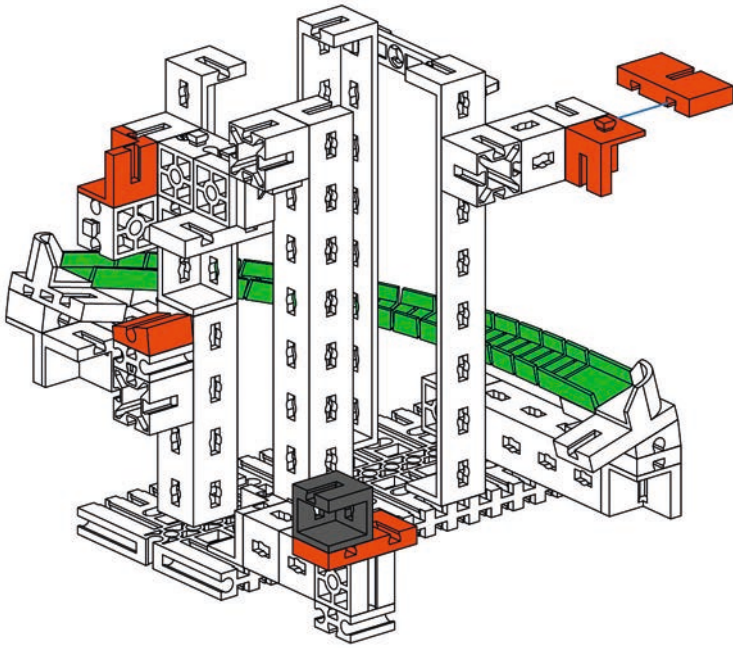

8

- 1 x Green Technic beam (11 holes)
- 1 x Orange Technic 15° connector
- 1 x Orange Technic 15° connector
- 2 x Orange Technic 15° connector
- 1 x Grey Technic connector
- 2 x Orange Technic 15° connector

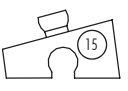

9

- 3 x Grey Technic beam (11 holes)
- 1 x Grey Technic beam (45 holes)
- 1 x Orange Technic pin (A)
- 2 x Orange Technic pin (A)
- 1 x Green Technic beam (11 holes)
- 1 x Grey Technic beam (11 holes)
- 1 x Orange Technic 15° connector
- 1 x Orange Technic 15° connector
- 1 x Green Technic connector
- 3 x Grey Technic connector

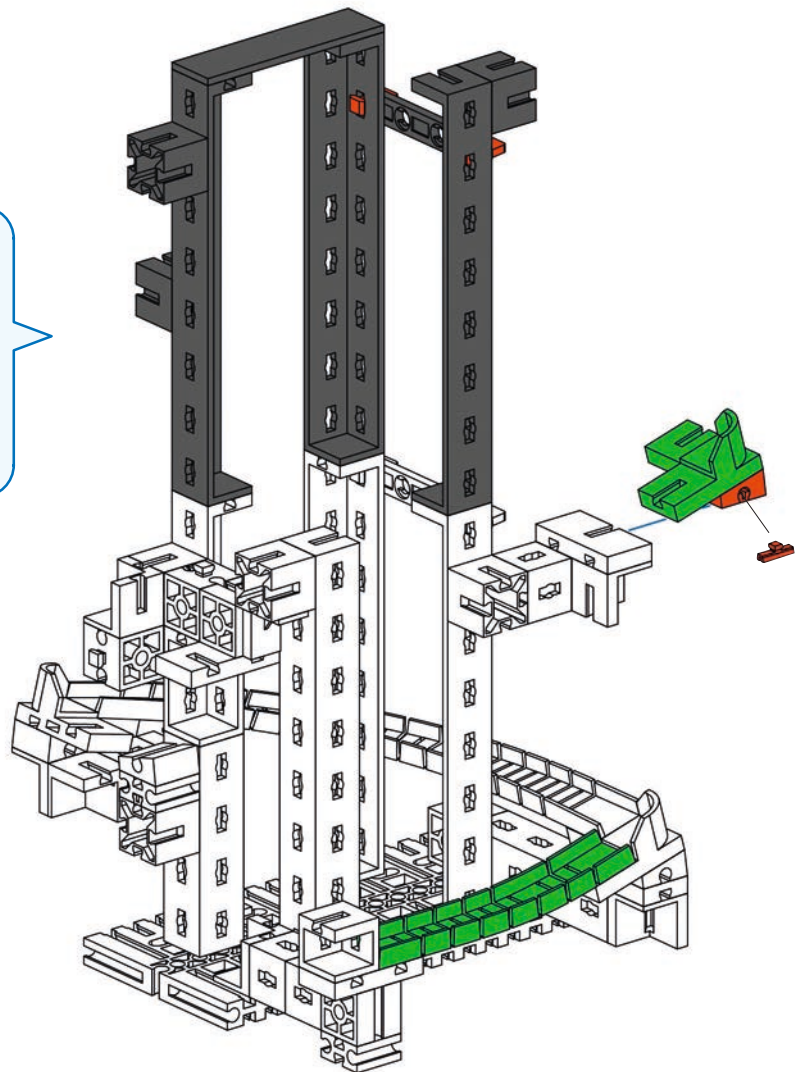
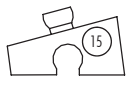

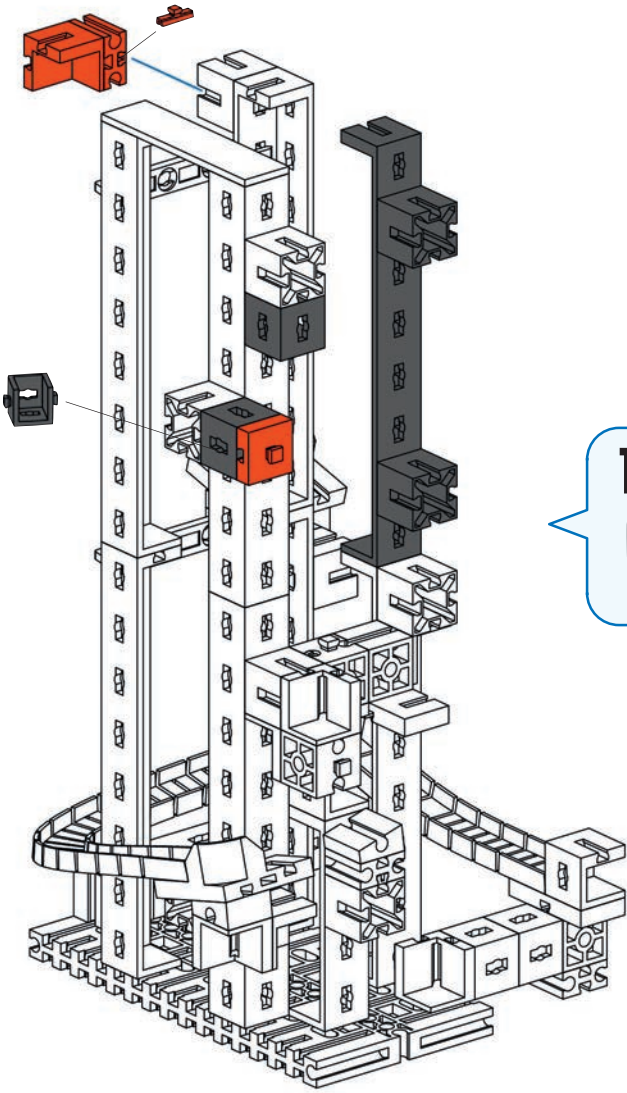

10

- 1x 1x6 grey Technic beam
- 1x grey 1-way connector
- 1x grey 2-way connector
- 2x grey 1-way connector
- 1x red 1-way connector
- 1x red 2-way connector
- 1x red 3-way connector
- 1x red 1-way connector



11

- 1x red 1-way connector
- 1x red 1-way connector
- 2x red 2-way connector

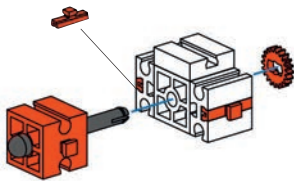
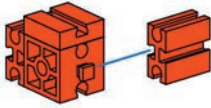

12

- 1x red 1-way connector
- 1x grey axle
- 2x red 1-way connector
- 1x black axle pin

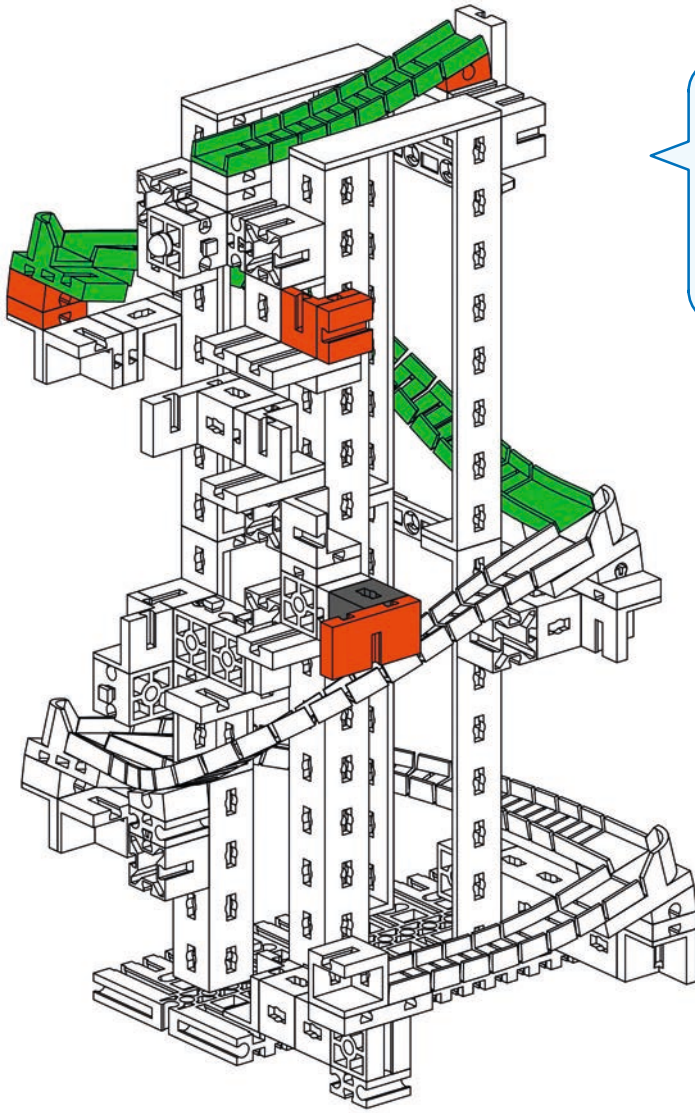

16

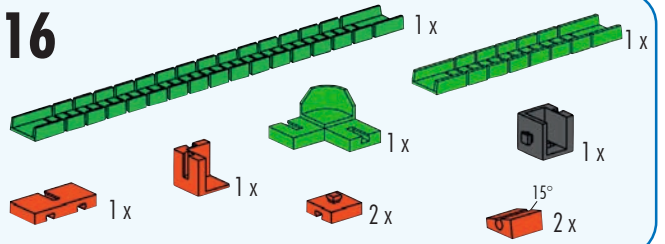

17

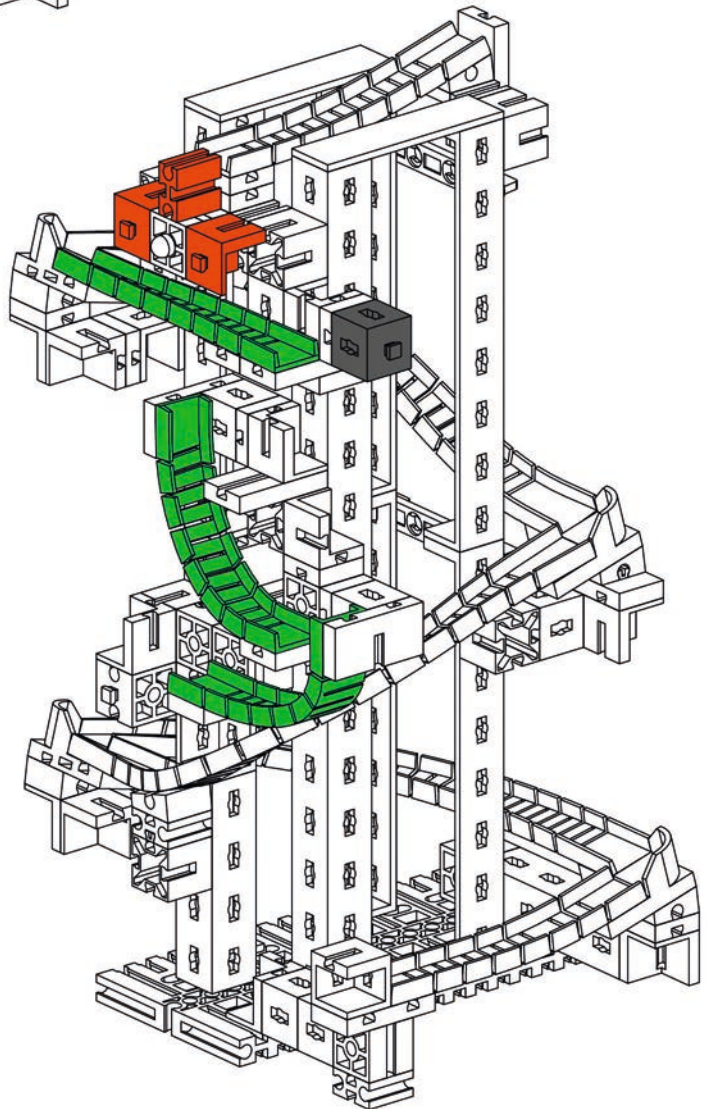
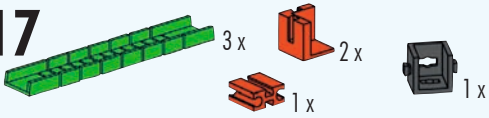

18

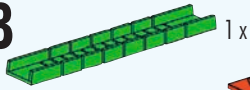

1x



3x



2x

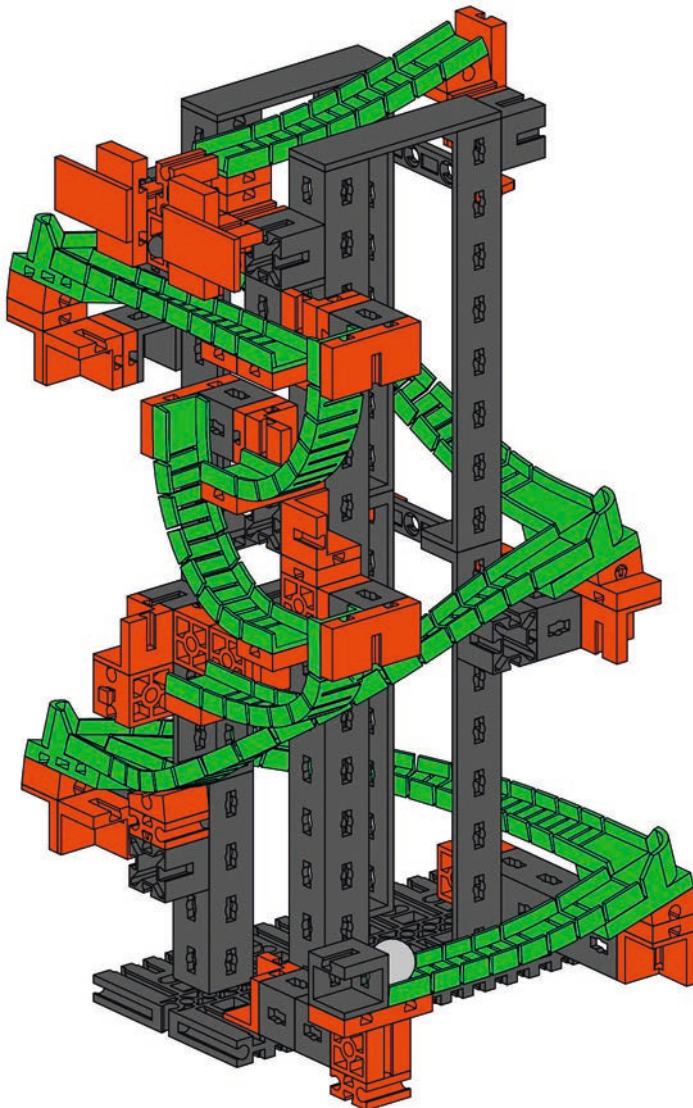
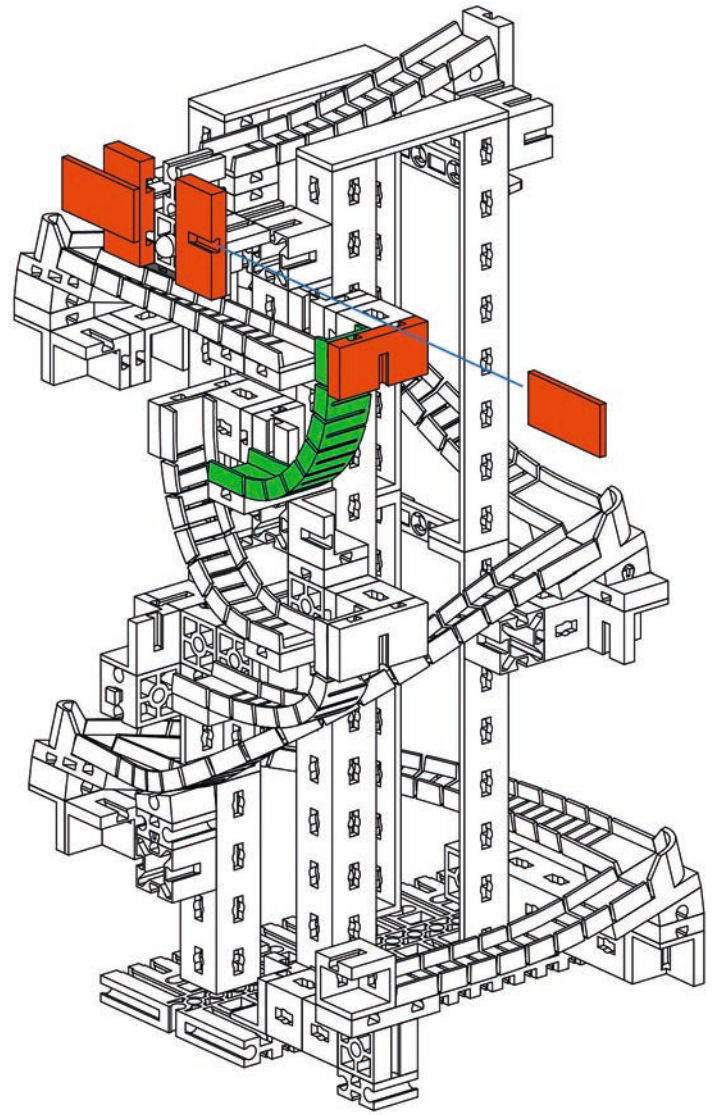

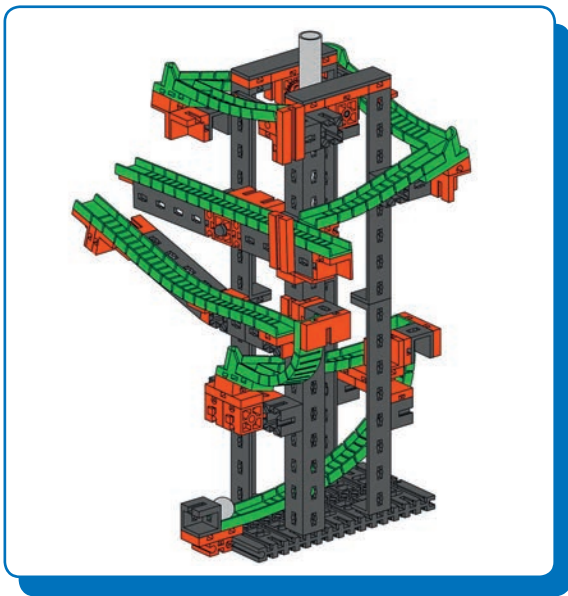

Action-Parcours
Action obstacle course
Parcours d'activités

Action-parcours
Pista de recorrido de acción
Circuito de ação

Circuito azione
Активная трасса
复杂的滚珠弯道

1

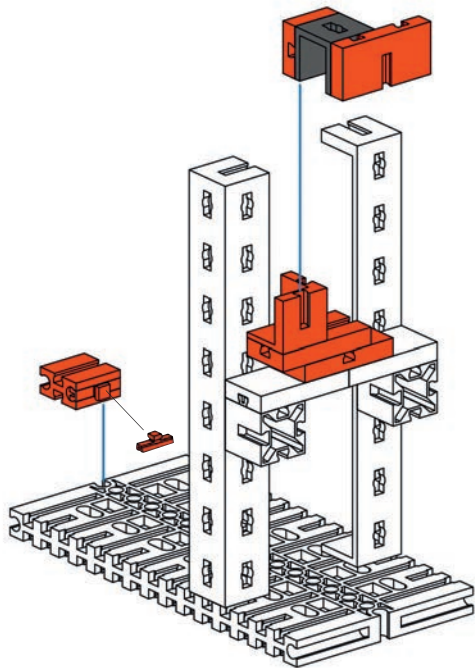
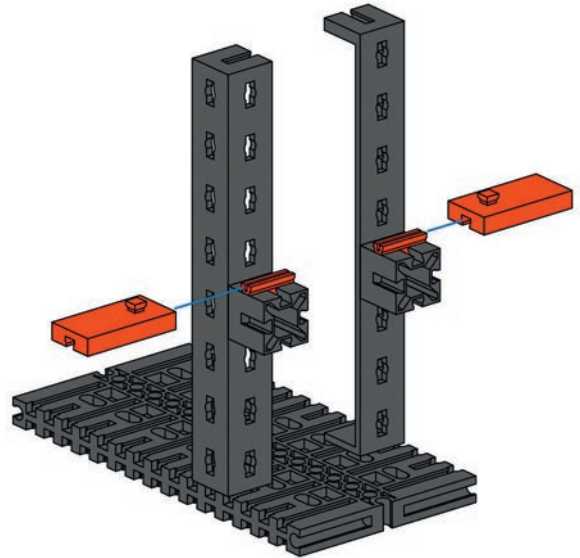

2

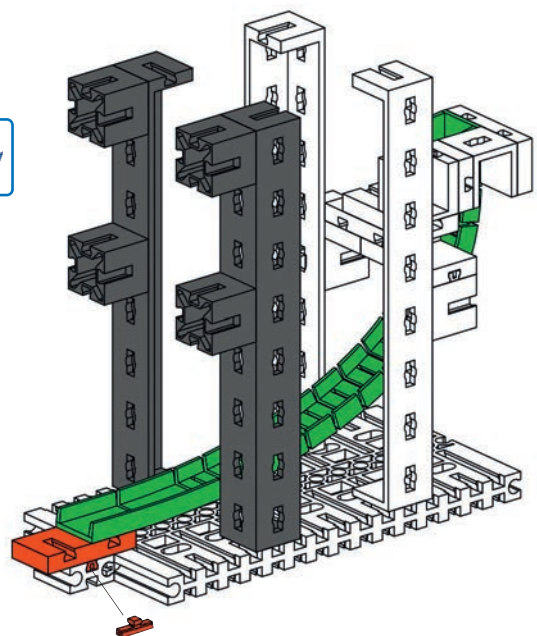

3

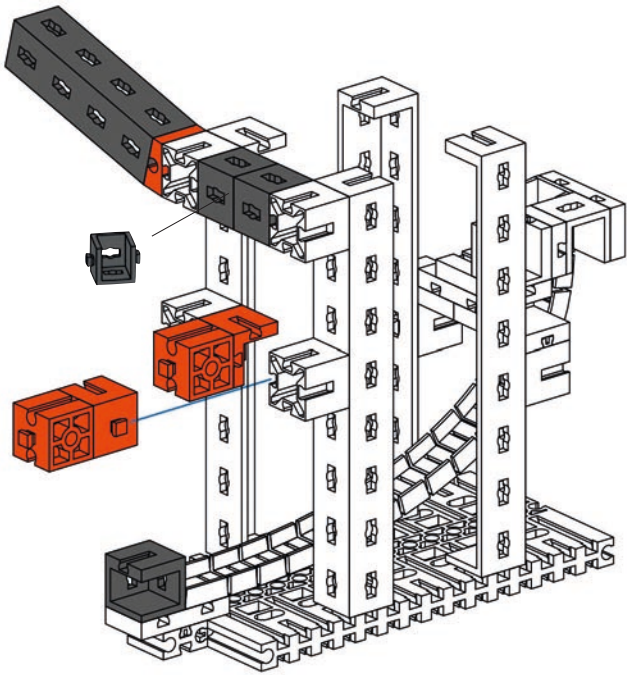

4

- 1 x grey Technic beam (1x5)
- 1 x grey Technic bush
- 2 x grey Technic bush
- 1 x orange Technic 15° wedge
- 2 x orange Technic L-shaped connector
- 2 x orange Technic 2-way connector

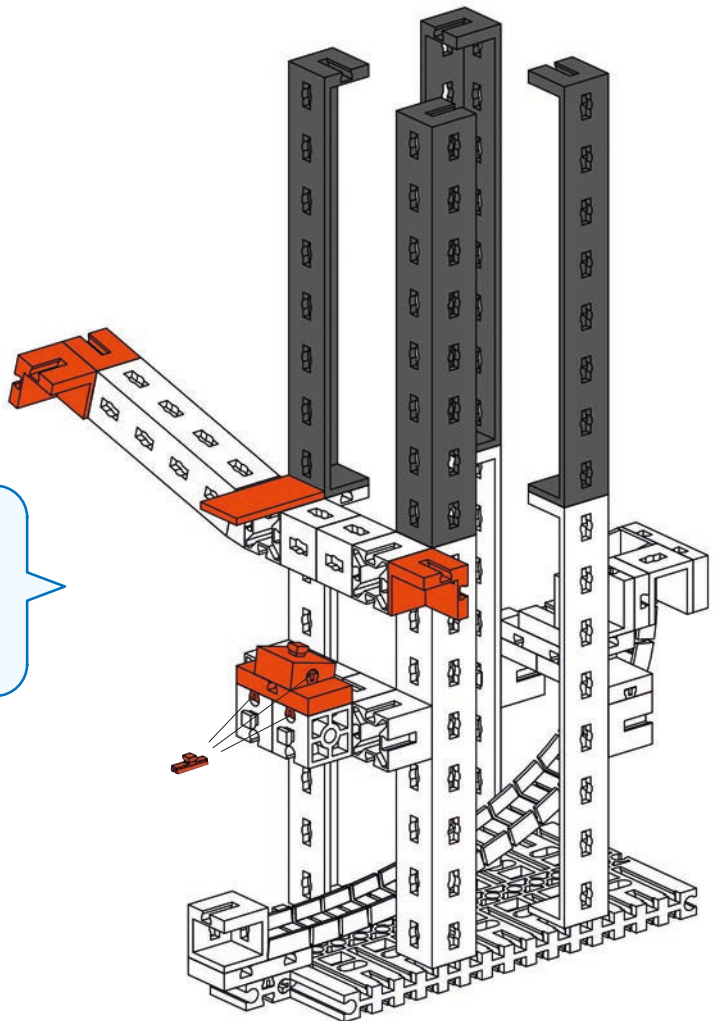

5

- 4 x grey Technic beam (1x5)
- 3 x orange Technic L-shaped connector
- 1 x orange Technic 2-way connector
- 3 x orange Technic 15° wedge
- 1 x orange Technic 2-way connector
- 1 x orange Technic 15° wedge



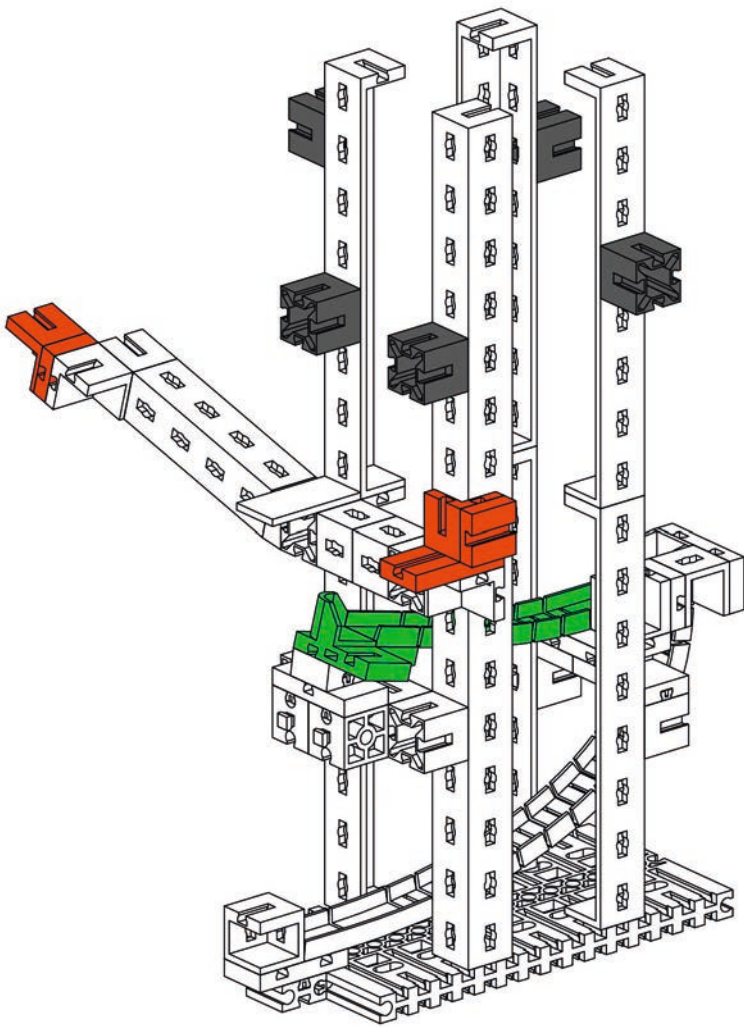

6

- 1 x Green 1x3 Technic brick
- 2 x Red 1x2 Technic brick
- 1 x Green 1x3 Technic brick with hole
- 1 x Red 1x2 Technic brick with hole
- 5 x Black 1x2 Technic connector
- 2 x Red 1x2 Technic brick with hole

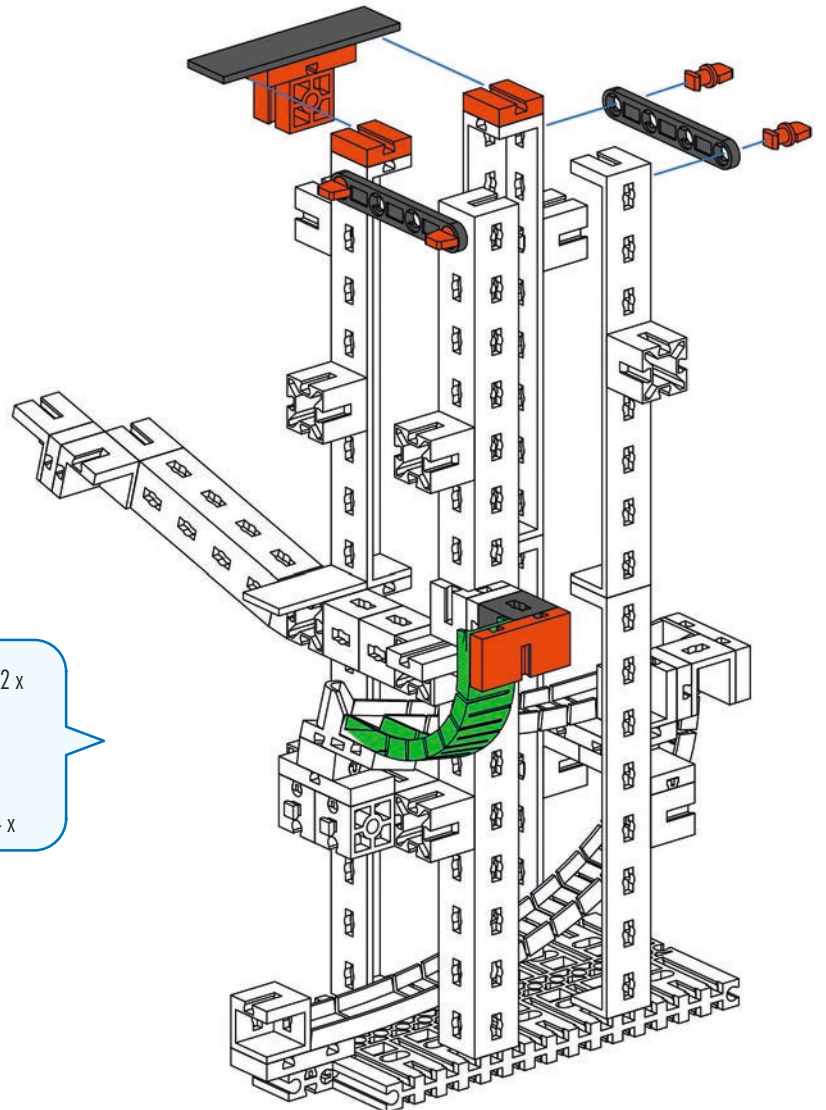

7

- 1 x Green 1x3 Technic brick
- 1 x Red 1x2 Technic brick with hole
- 2 x Black 1x5 Technic axle with grey bush
- 1 x Black 1x2 Technic connector
- 2 x Red 1x2 Technic brick with hole
- 1 x Black 1x2 Technic connector
- 4 x Red 1x2 Technic brick with hole

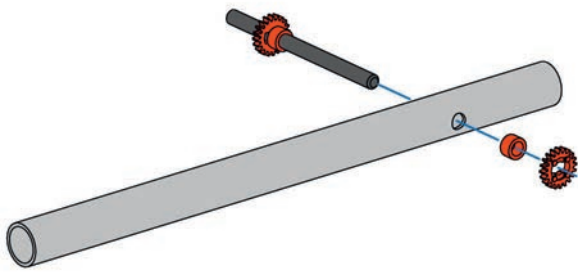

8

179 1 x

60 1 x

2 x 2 x

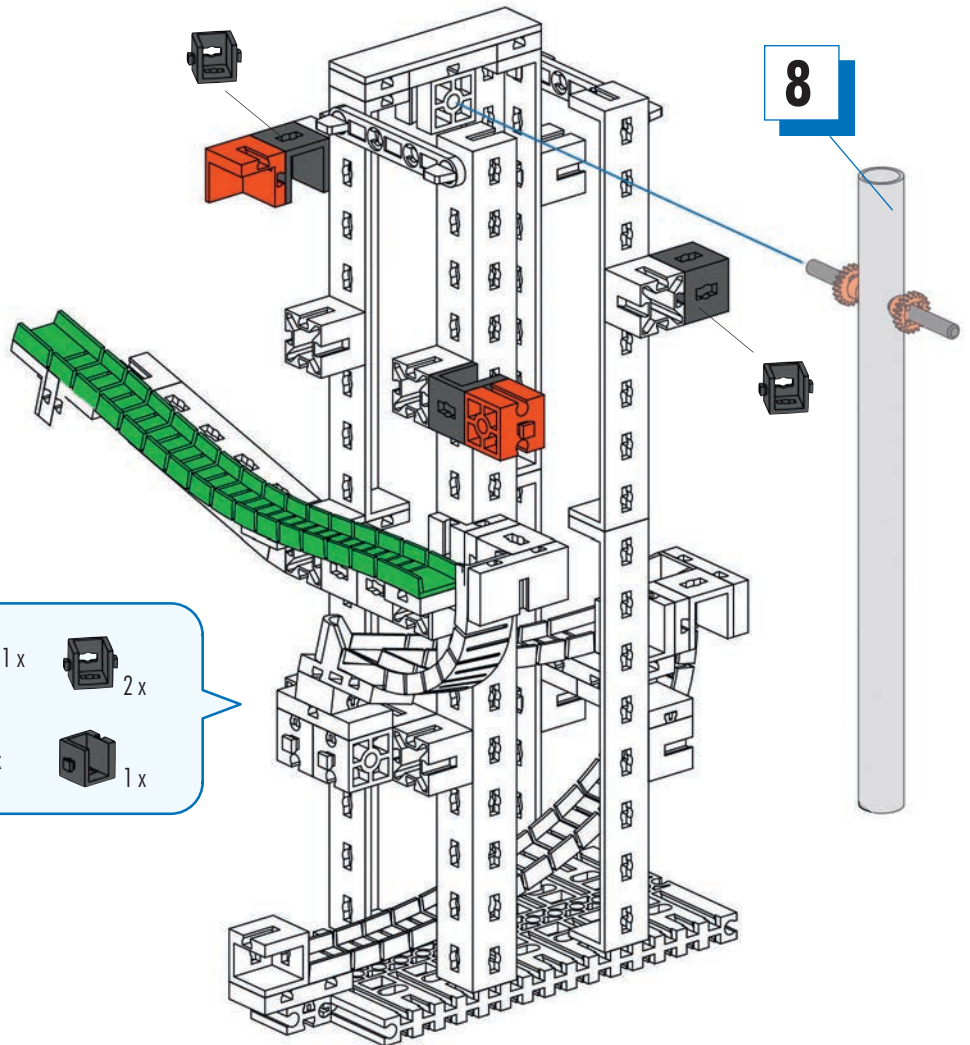

9

1 x 2 x

1 x 1 x 1 x

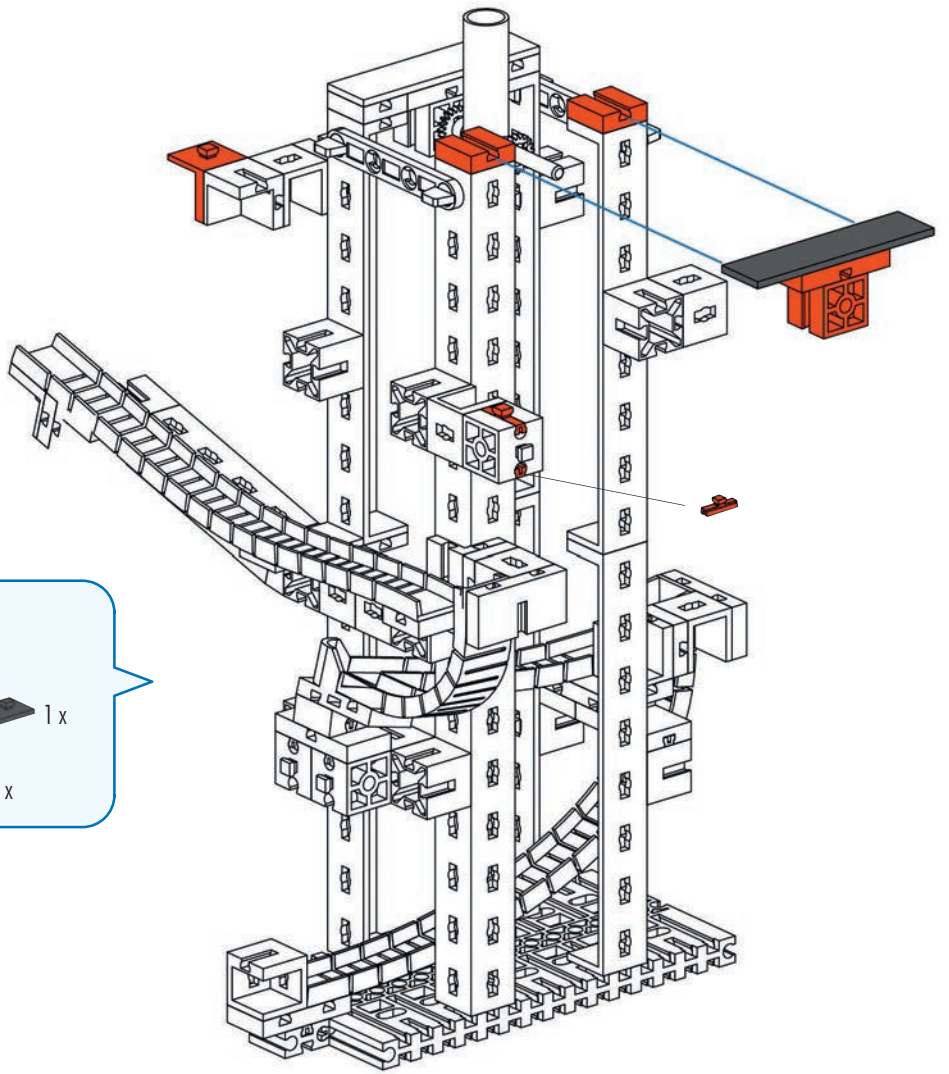

10

- 1x (orange 1x2 Technic brick with hole)
- 1x (orange 1x2 Technic brick with hole)
- 2x (orange 1x2 Technic brick with hole)
- 1x (grey 1x4 Technic Technonut)
- 1x (orange 1x2 Technic brick with hole)
- 2x (orange 1x2 Technic brick with hole)

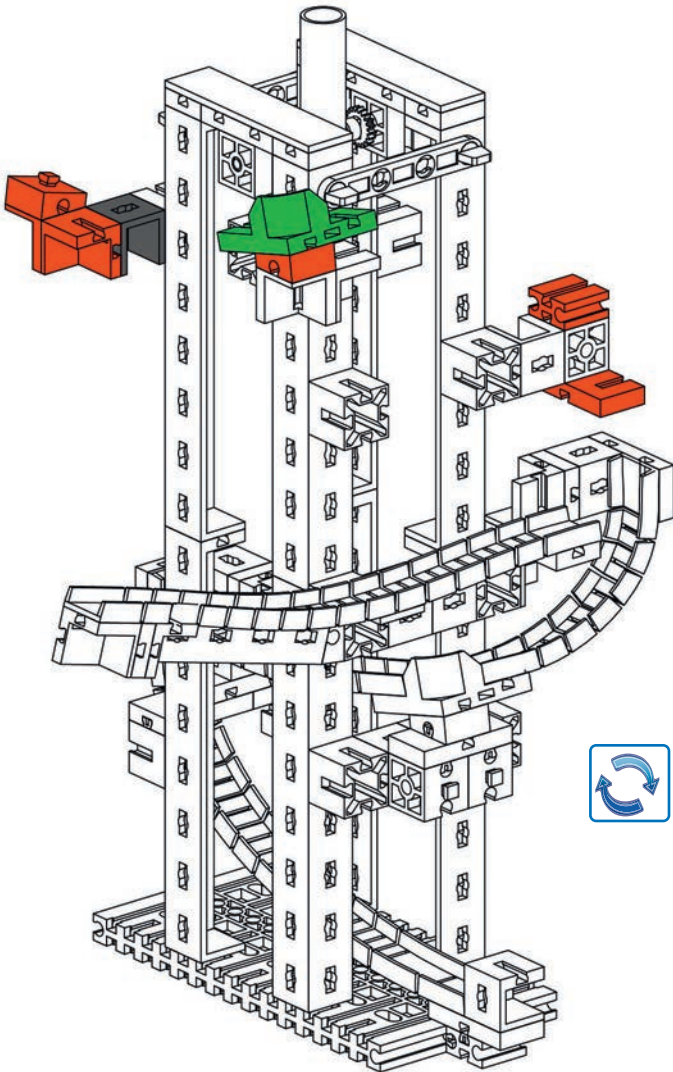

11

- 1x (orange 1x2 Technic brick with hole)
- 1x (orange 1x2 Technic brick with hole)
- 1x (grey 1x2 Technic Technonut)
- 1x (green 1x2 Technic Technonut)
- 2x (orange 1x2 Technic brick with hole)
- 2x (orange 1x2 Technic brick with hole, 15°)

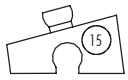

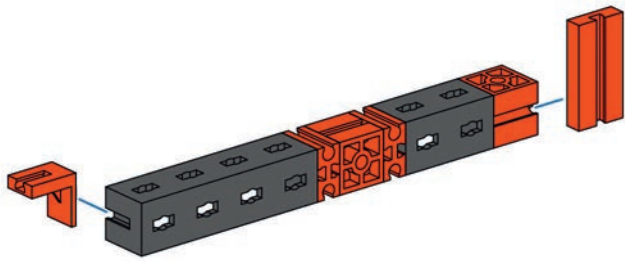

12

- 1x grey 1x6 Technic beam
- 1x grey 1x3 Technic beam
- 2x orange 1x2 Technic connector
- 2x orange 1x2 Technic connector
- 1x orange 1x2 Technic connector
- 1x orange 1x2 Technic connector

13

- 1x green 1x12 Technic beam
- 1x grey 1x2 Technic connector
- 1x orange 1x2 Technic connector

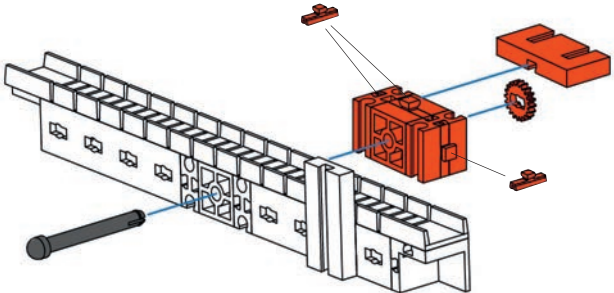
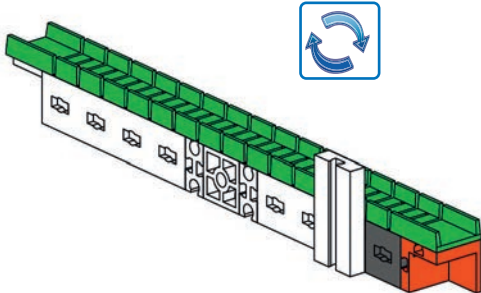

14

- 1x orange 1x2 Technic connector
- 1x orange 1x2 Technic connector
- 2x orange 1x2 Technic connector
- 3x orange 1x2 Technic connector
- 1x grey axle
- 1x black axle pin

15

- 3 x
- 1 x
- 1 x
- 1 x
- 1 x

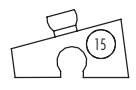
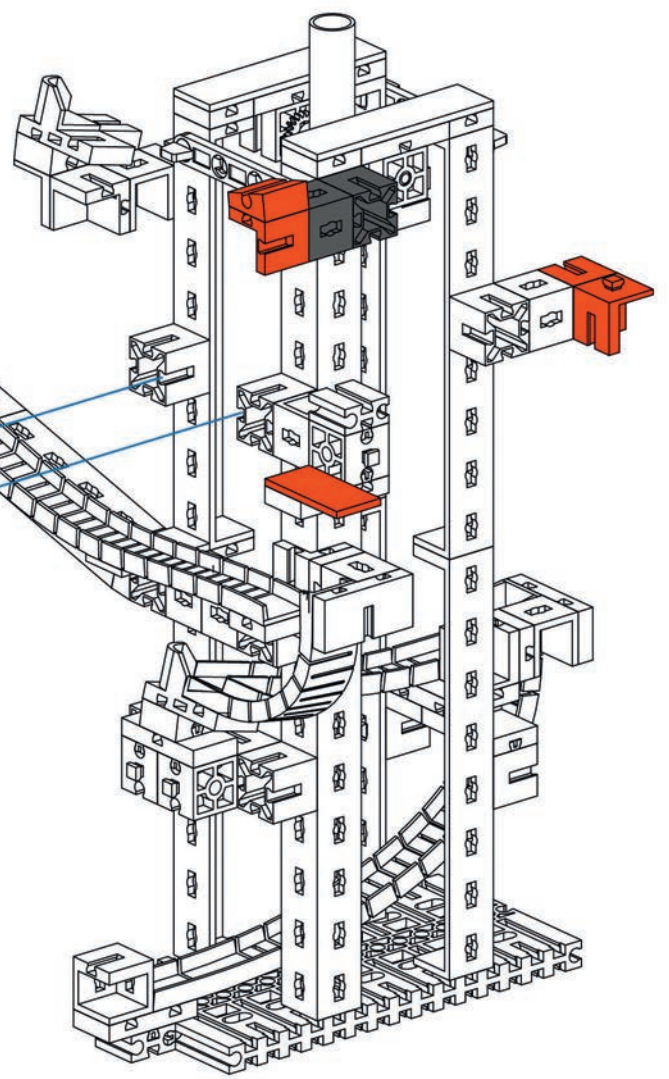

14

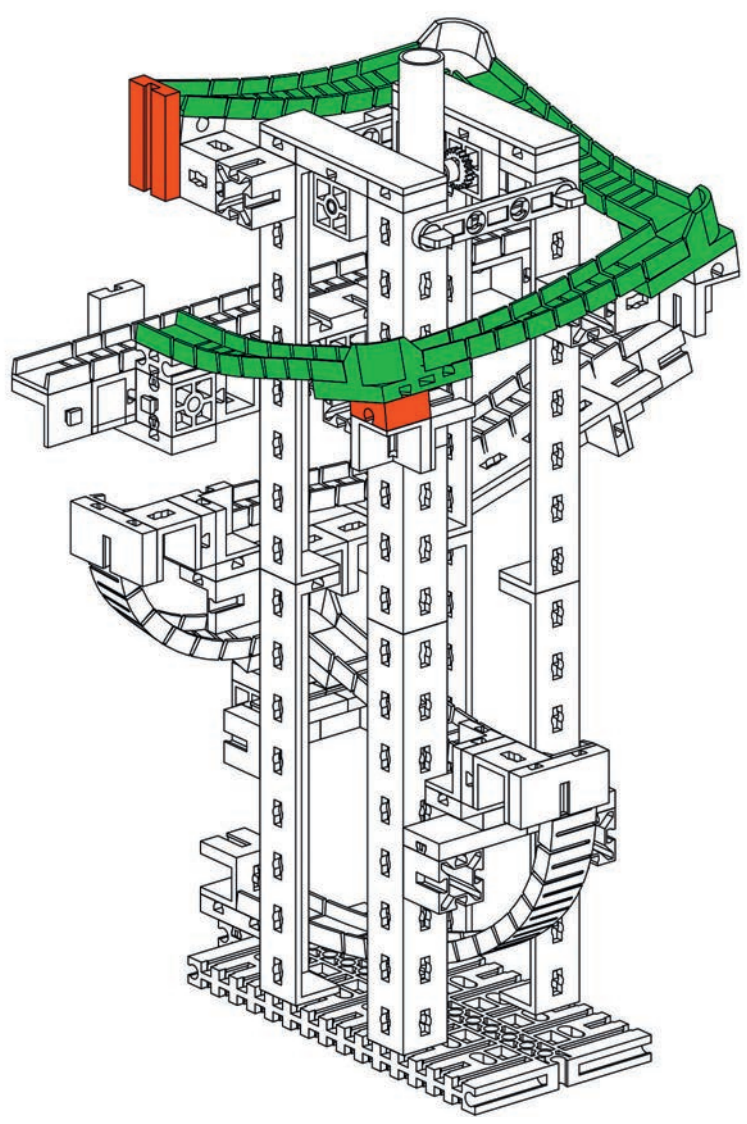
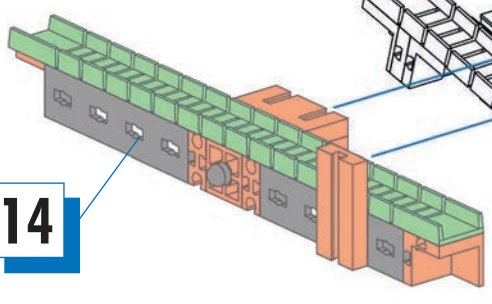

16

- 4 x
- 2 x
- 1 x
- 1 x

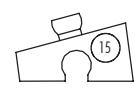

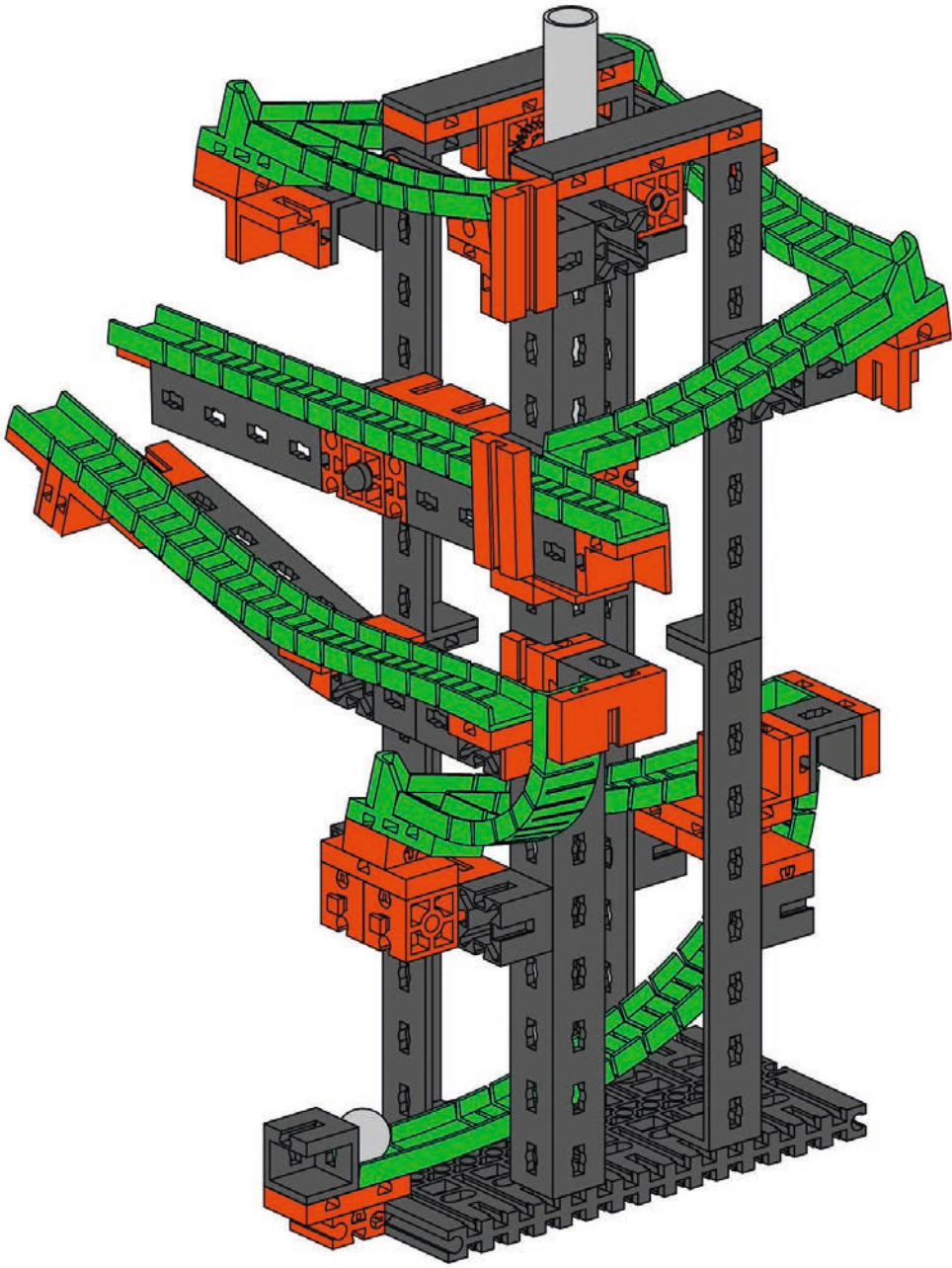



fischertechnik 

PROFI

fischertechnik GmbH
Klaus-Fischer-Str. 1
72178 Waldachtal
Germany
Phone: +49 74 43/12-43 69
Fax: +49 74 43/12-45 91
info@fischertechnik.de
www.fischertechnik.de

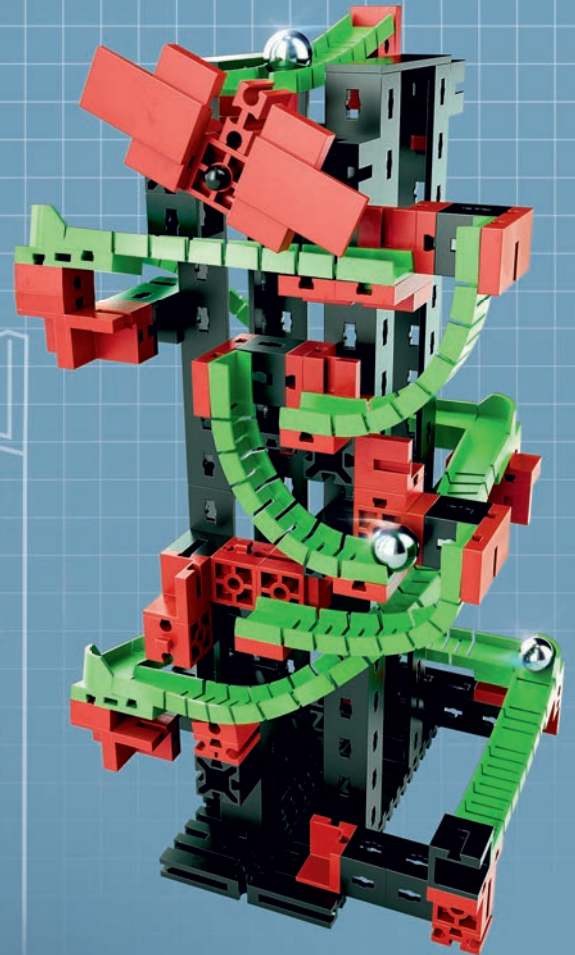
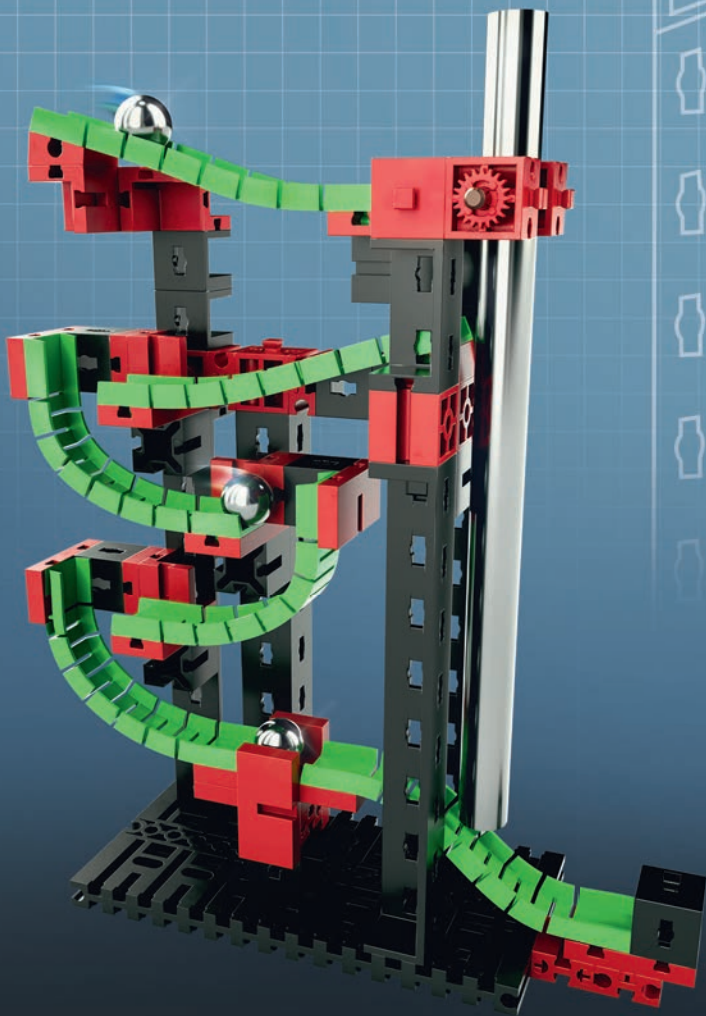

Dynamic S

3 MODELS