

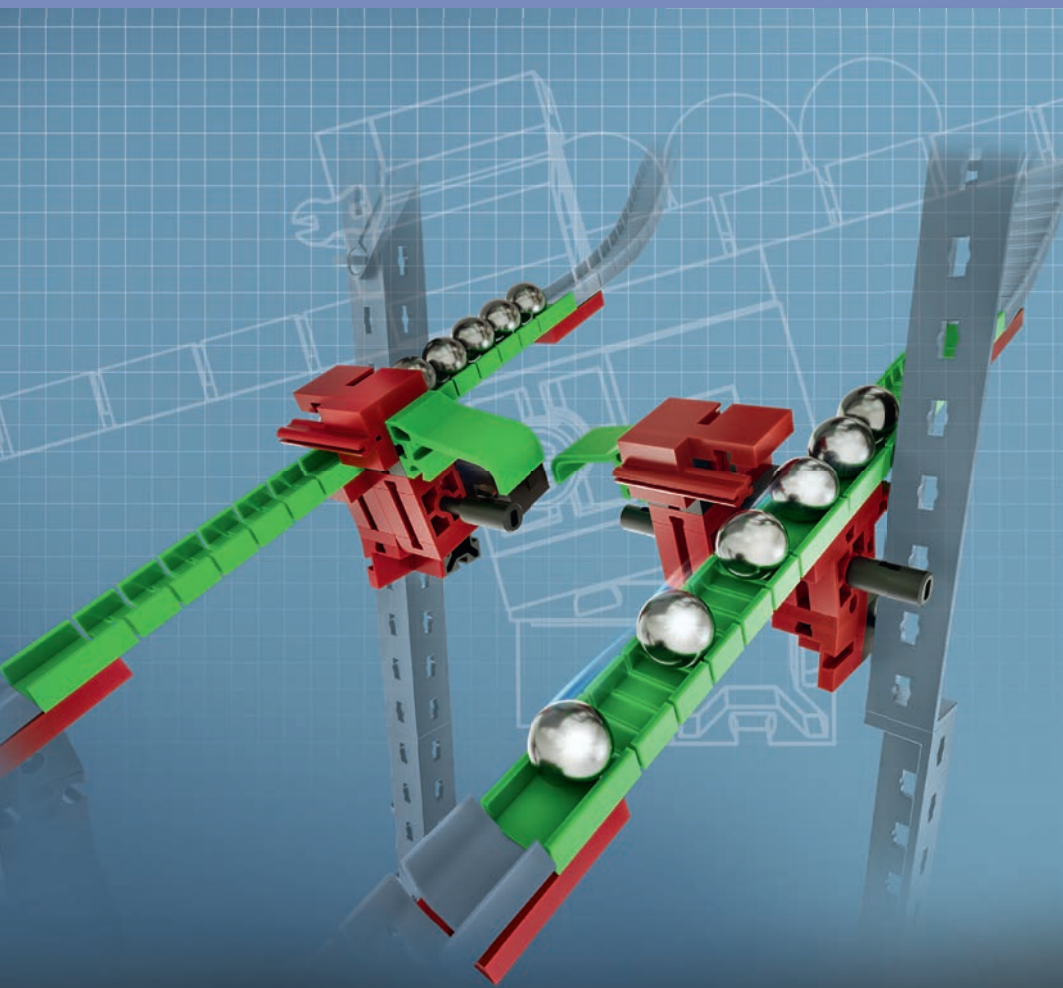

fischertechnik 

PLUS



Dynamic Stop & Go

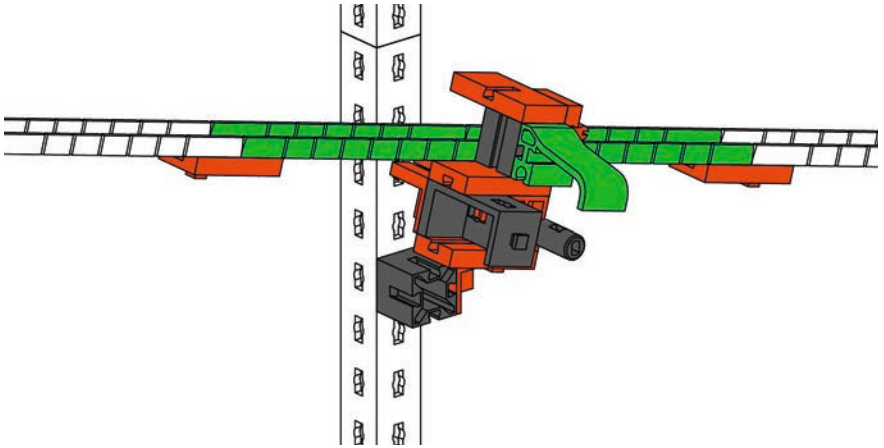



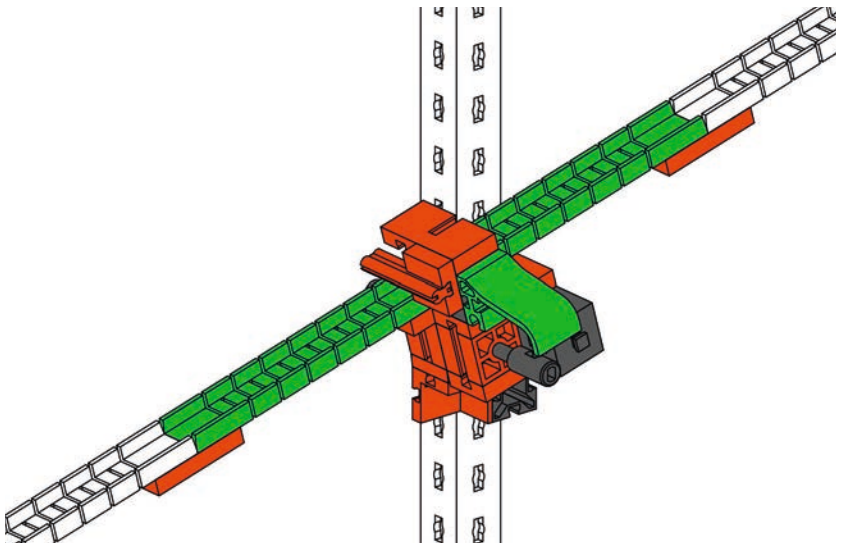









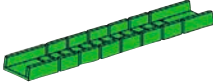

rechts / right / droite / rechts / derecha / à direita / destra / правое / 右2

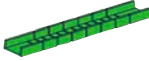

links / left / gauche / links / izquierda / à esquerda / sinistra / левое / 左4

Nur farbig dargestellte Teile im Set enthalten / Set contains only parts shown in color / Seules les pièces représentées en couleur sont contenues dans le kit / Alleen in kleur weergegeven onderdelen zijn bij de set inbegrepen / Solo las piezas en color están incluidas en el set / Apenas as peças representadas em cores estão contidas no kit / Il kit comprende solo i particolari raffigurati a color / В комплект входят только показанные цветными детали / 用颜色标出的零件才包含在套件中

	31 061 2 x		35 049 8 x		38 428 4 x
	31 981 2 x		35 065 2 x		155 901 4 x
	31 982 4 x		35 073 4 x		163 200 2 x
	32 064 4 x		36 920 2 x		
	32 850 2 x		37 237 2 x		Erfinder Flexprofil 155 901 Design und Konzeption Andreas Lehrberger
	32 881 2 x		38 240 4 x		

Sicherheitshinweise
Safety Information
Consignes de sécurité

Veiligheidsrichtlijnen
Indicaciones de seguridad
Observações sobre segurança

Informazioni per la sicurezza
Указания по технике безопасности
安全指南

- Alle Einzelteile, insbesondere bewegliche Teile sind falls notwendig zu warten und zu reinigen.
- All components, especially moving parts, should be maintained and cleaned as necessary.
- Toutes les pièces détachées et en particulier les pièces mobiles, sont, si nécessaire, à entretenir et à nettoyer.
- Alle onderdelen, vooral de bewegende delen, kunnen, indien noodzakelijk, onderhouden en gereinigd worden.
- Es necesario limpiar y mantener en buen estado todas las diferentes piezas - especialmente las piezas móviles.
- Caso necessário, todas as peças individuais, especialmente peças móveis, tem que ser submetidas à manutenção e ser limpidas.
- Se necessario, tutti i singoli componenti, soprattutto le parti mobili, si devono eventualmente sottoporre a manutenzione e pulizia.
- Все детали, особенно подвижные, требуют ухода и чистки.
- 必要时应保养和清洁所有零件，尤指运动部件。

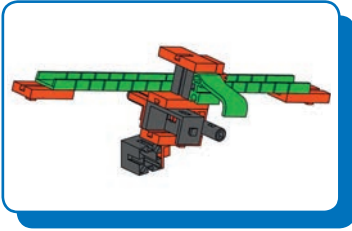

1

- Orange L-shaped Technic brick 1 x
- Orange Technic brick with hole 1 x
- Orange Technic brick with hole 15° 1 x
- Grey Technic axle of length 60 1 x
- Orange Technic pin 1 x
- Grey Technic axle pin 1 x

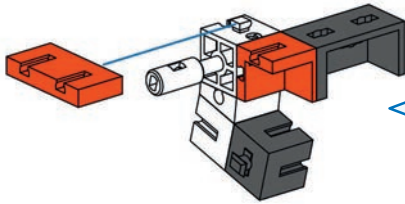
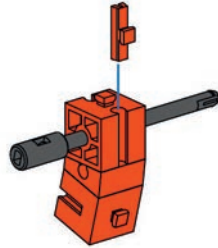

2

- Orange L-shaped Technic brick 1 x
- Grey Technic axle of length 60 1 x
- Orange Technic pin 1 x
- Grey Technic axle pin 1 x

3

- Green Technic beam of length 2 x
- Orange Technic brick 4 x
- Orange Technic brick with hole 1 x

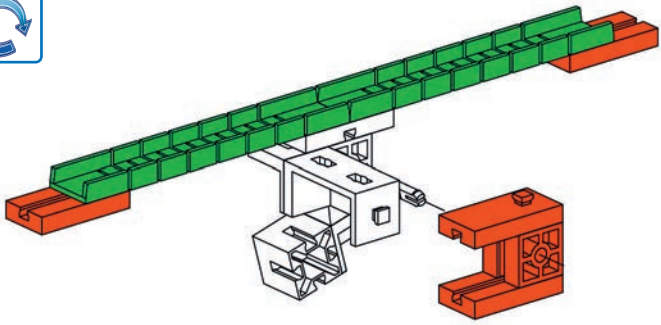

4

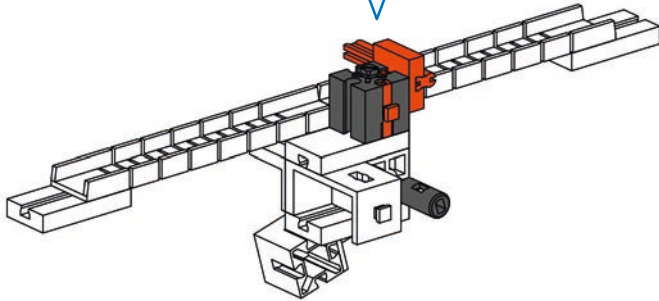
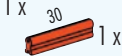

5

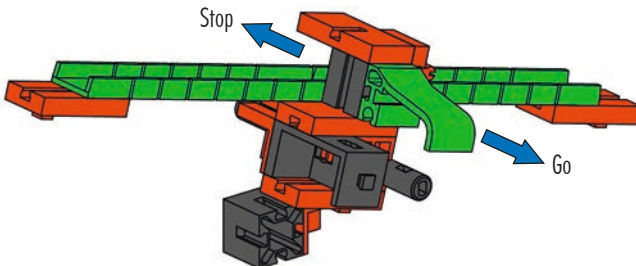
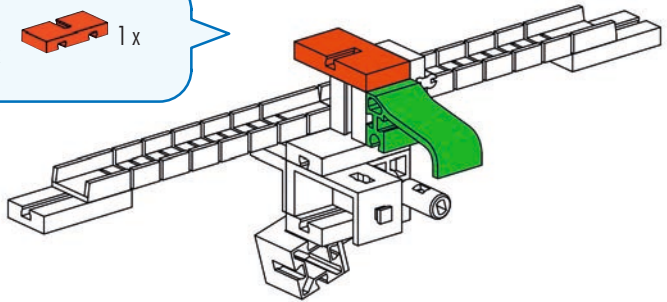
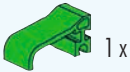

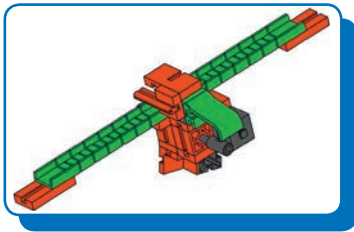

1

- 1 x Orange L-shaped Technic connector
- 1 x Orange Technic connector with a hole
- 1 x Orange Technic connector with a 15° angle
- 1 x Grey Technic axle of length 60
- 1 x Grey Technic axle pin

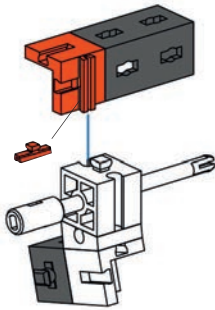
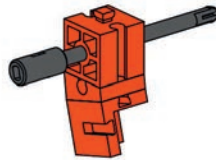





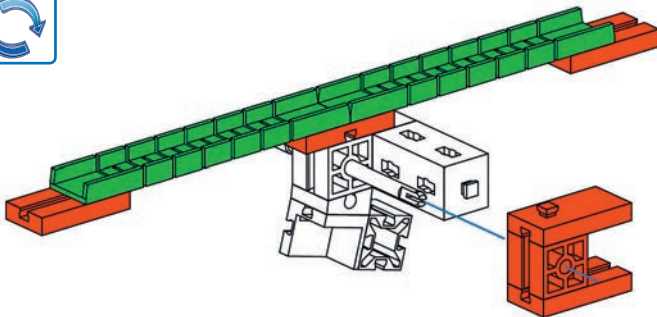

2

- 1 x Orange L-shaped Technic connector
- 1 x Grey Technic connector with a hole
- 1 x Orange Technic connector with a hole
- 1 x Grey Technic connector with a hole



3

- 2 x Green Technic beam
- 4 x Orange Technic connector
- 1 x Orange Technic connector with a hole
- 1 x Orange Technic connector with a hole

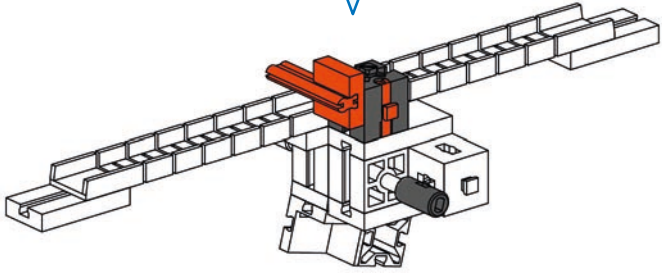

4  1x  1x  30 1x  1x  1x



5  1x  1x

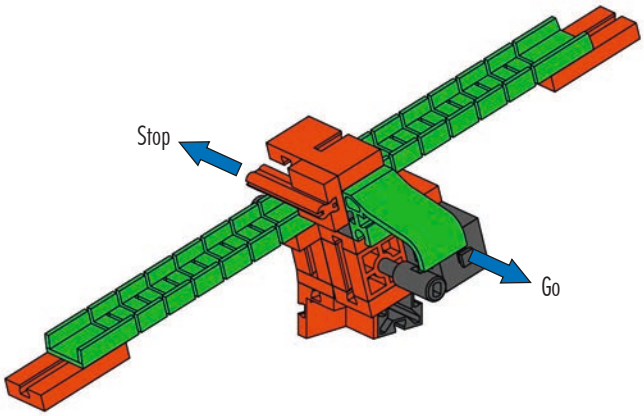
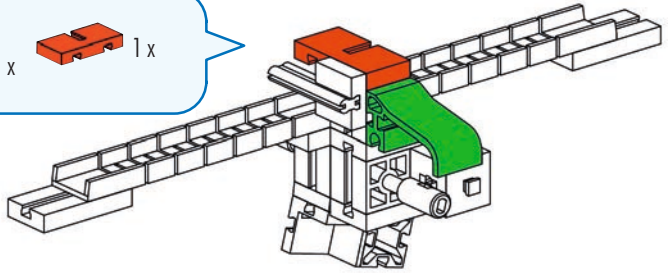

fischertechnik GmbH
Klaus-Fischer-Str. 1
72178 Waldachtal
Germany

Phone +49 74 43/12-43 69
Fax +49 74 43/12-45 91
info@fischertechnik.de
www.fischertechnik.de



fischertechnik 

PLUS

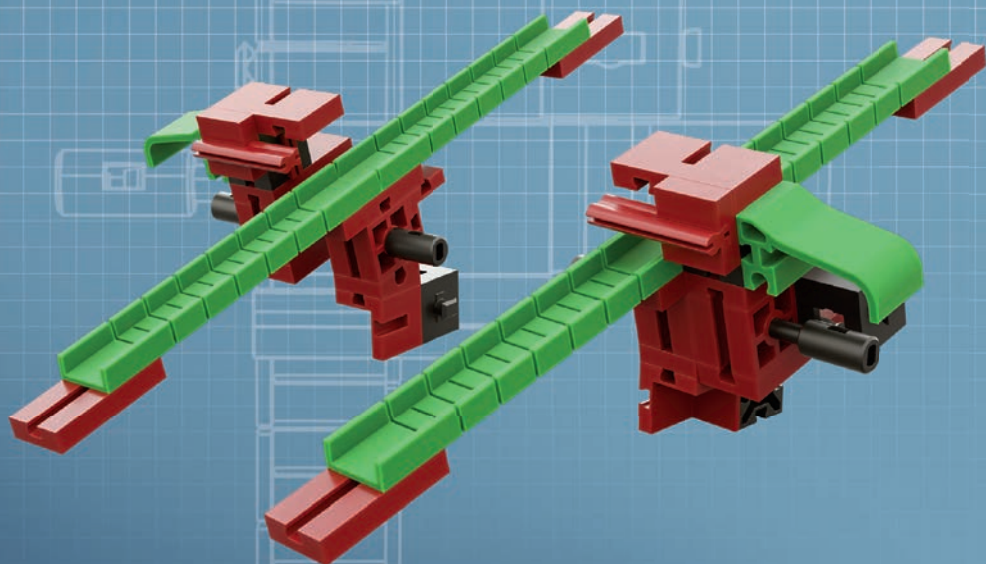

Dynamic Stop & Go