

208251 - 02/24 - Co. - Printed in Germany - Technische Änderungen vorbehalten - Subject to technical modifications

# Marble Competition Battle

**fischertechnik GmbH**

Klaus-Fischer-Str. 1  
72178 Waldachtal  
Germany

Phone: +49 74 43/12-43 69  
Fax: +49 74 43/12-45 91

info@fischertechnik.de  
www.fischertechnik.de

















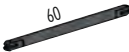
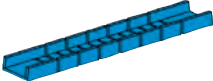











[www.fischertechnik.de](http://www.fischertechnik.de)

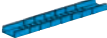

Bauanleitung  
Assembly instruction  
Instructions de montage  
Bouwhandleiding  
Instrucciones de construcción

Manual de montagem  
Istruzioni di montaggio  
Инструкция по сборке  
安装说明书

# Marble Competition Battle

	32 850 1 x		160 541 1 x		208 234 4 x
	32 879 1 x		160 545 3 x		208 235 5 x
	35 065 4 x		161 691 2 x		208 236 5 x
	35 066 2 x		165 792 1 x		208 239 1 x
	35 073 5 x		167 370 1 x		208 240 3 x
	35 971 4 x		208 227 1 x		208 241 2 x
	35 972 2 x		208 228 2 x		208 242 8 x
	36 227 3 x		208 229 3 x		208 244 3 x
	36 920 2 x		208 230 2 x	  Erfinder Flexprofil 161 691 + Wechsel- weiche 165 792 Design und Konzeption Andreas Lehrberger	
	36 922 2 x		208 232 4 x		

- Alle Einzelteile, insbesondere bewegliche Teile sind falls notwendig zu warten und zu reinigen.
- All components, especially moving parts, should be maintained and cleaned as necessary.
- Toutes les pièces détachées et en particulier les pièces mobiles, sont, si nécessaire, à entretenir et à nettoyer.
- Alle onderdelen, vooral de bewegende delen, kunnen, indien noodzakelijk, onderhouden en gereinigd worden.
- Es necesario mantener limpio y en buen estado cada una de las piezas. Particularmente las piezas móviles.

- Todas as peças individuais, especialmente peças móveis, devem ser submetidas à manutenção e limpas se necessário.
- Se necessario, tutti i singoli componenti, soprattutto le parti mobili, si devono eventualmente sottoporre a manutenzione e pulizia.
- Все детали, особенно подвижные, требуют ухода и чистки.
- 必要时应保养和清洁所有零件，尤指运动部件。



[www.fischertechnik.de/FanClub](http://www.fischertechnik.de/FanClub)

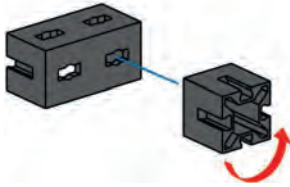
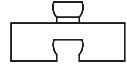
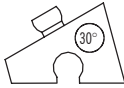
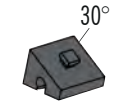

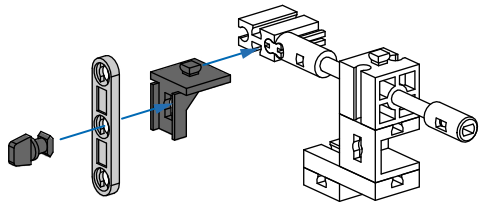
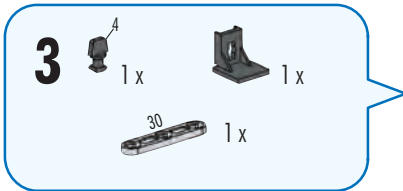
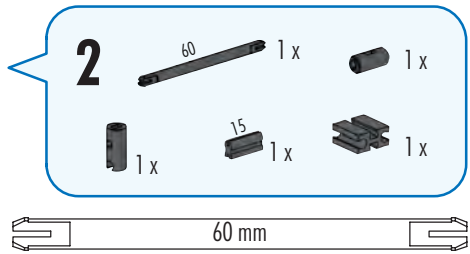
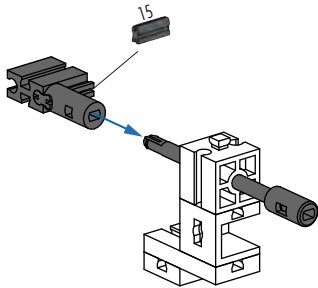
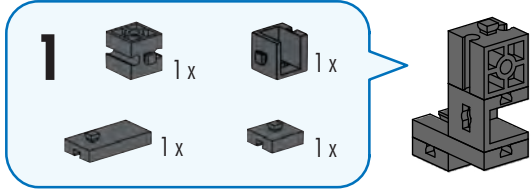
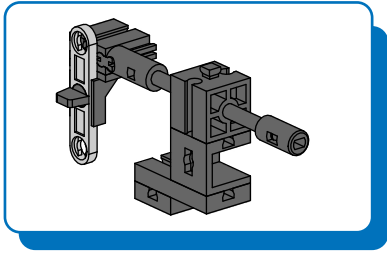





Marble Competition  
564 070

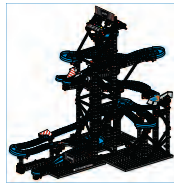

Race Track 1

4

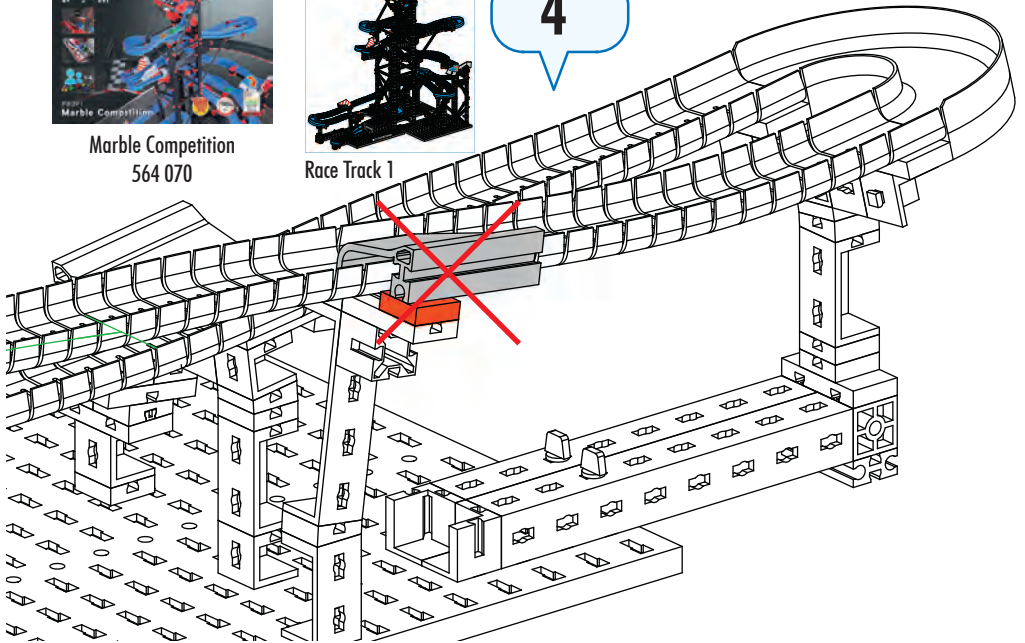

Farbige Bauteile ausbauen, werden beim weiteren Bauen benötigt / Removing colored components is required for further construction / Démontez les éléments colorés, ils seront nécessaires pour la suite de la construction / Verwijderen van gekleurde onderdelen is nodig voor verdere constructie / Para seguir construyendo es necesario retirar los componentes coloreados / A remoção de componentes coloridos é necessária para a construção posterior / La rimozione dei componenti colorati è necessaria per la costruzione successiva / Удаление цветных компонентов необходимо для дальнейшего строительства / 为进一步施工，需要拆除有色部件

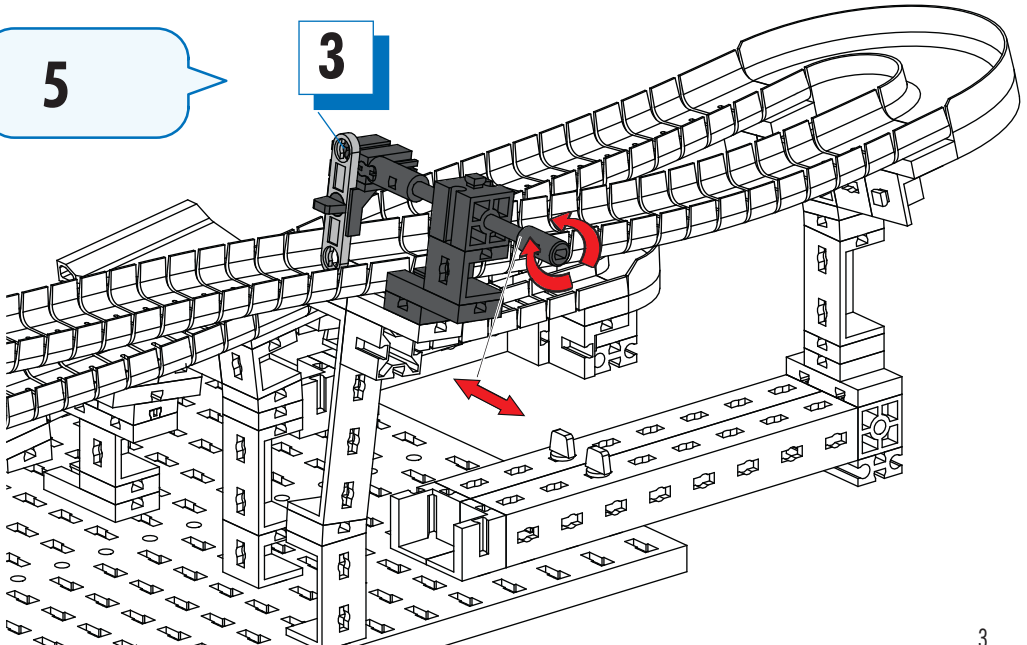

5

3

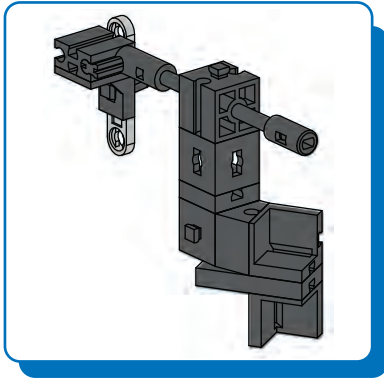





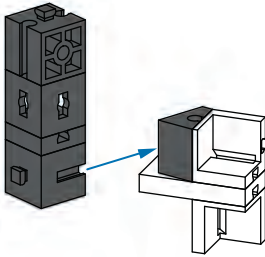
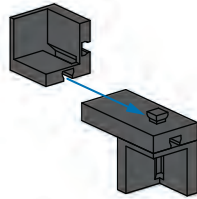

**1**

2x  1x 





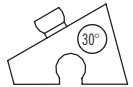

**2**

1x  1x  1x   
 1x  1x 



**3**

60  1x  1x  
 1x  1x  1x 1x  1x

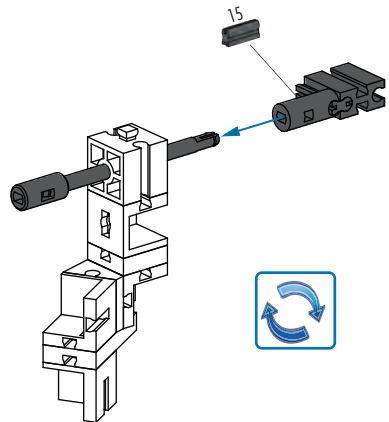
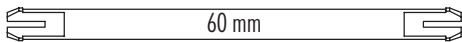

**4**

4 1x

30 1x

1x

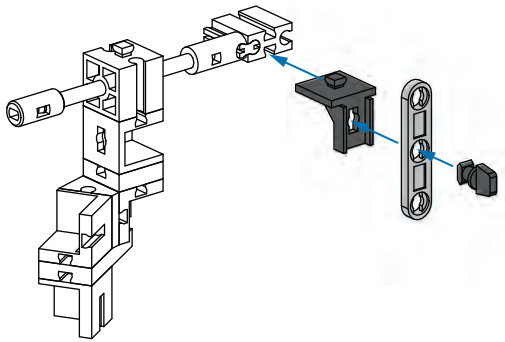

Marble Competition  
564 070

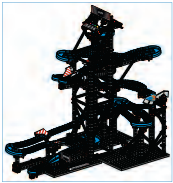

Race Track 1

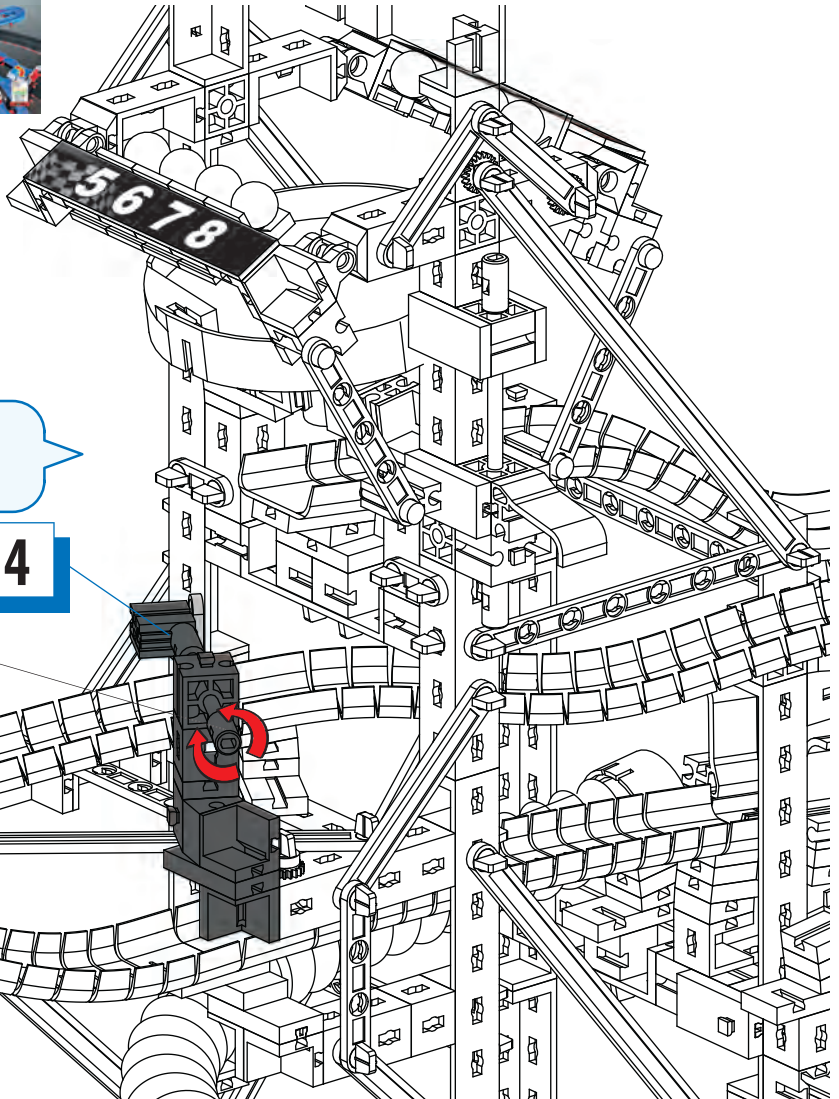

**5**

**4**

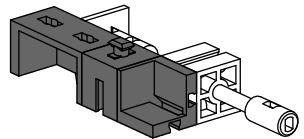
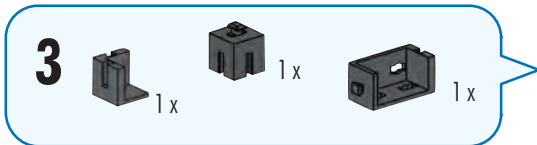
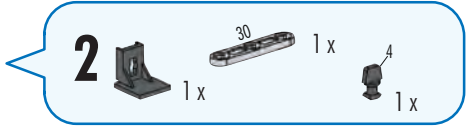
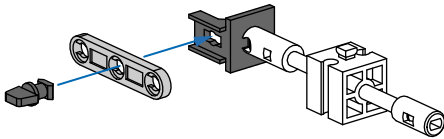
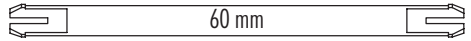
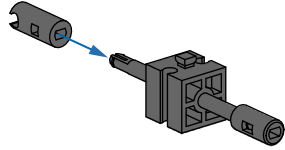
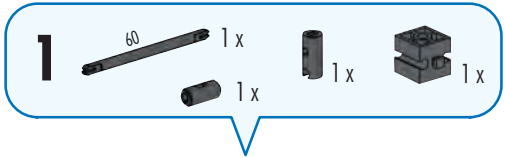
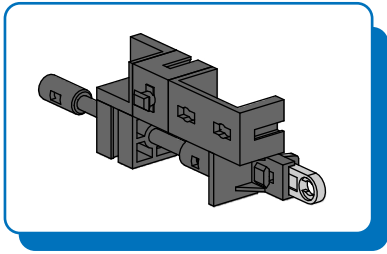

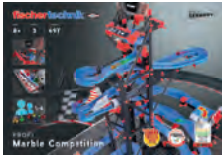

Marble Competition  
564 070

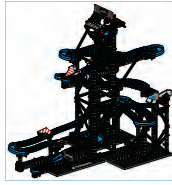

Race Track 1

4

3

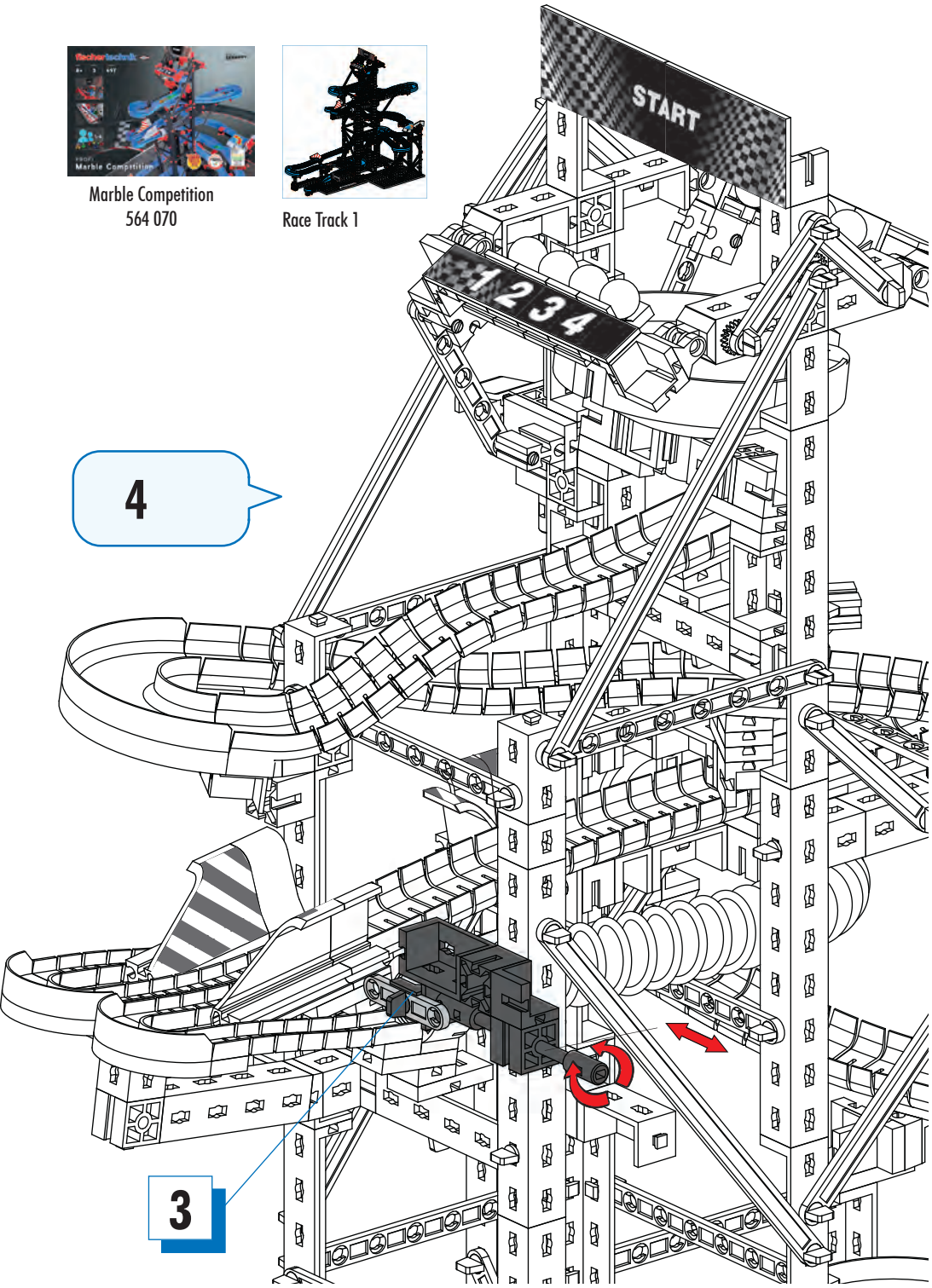
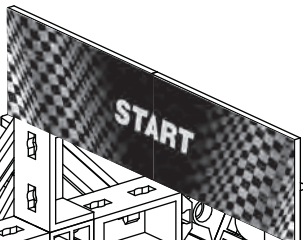



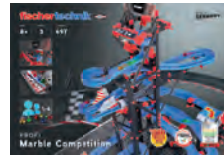
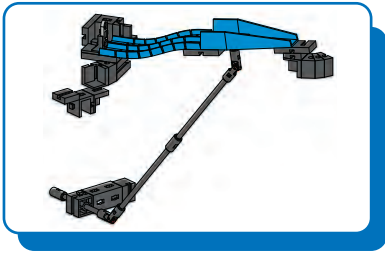

Marble Competition  
564 070

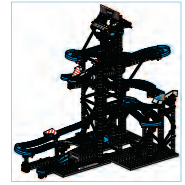

Race Track 1

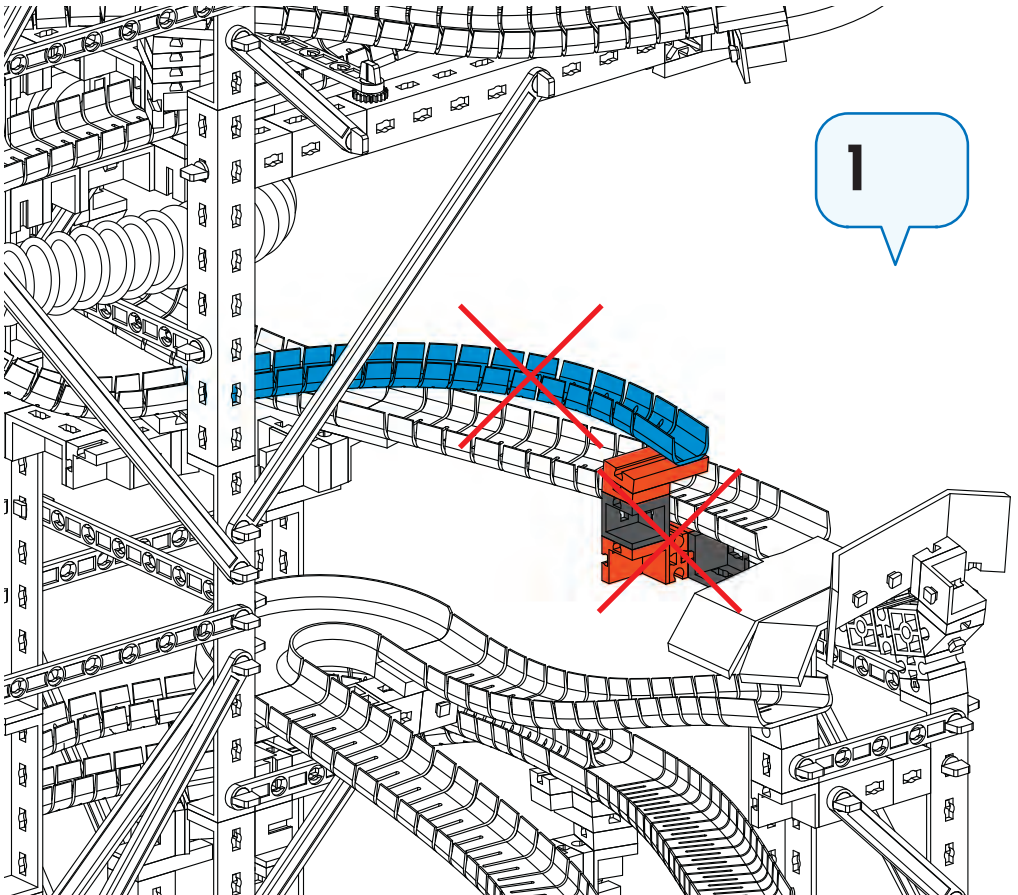





Farbige Bauteile ausbauen, werden beim weiteren Bauen benötigt / Removing colored components is required for further construction / Démontez les éléments colorés, ils seront nécessaires pour la suite de la construction / Verwijderen van gekleurde onderdelen is nodig voor verdere constructie / Para seguir construyendo es necesario retirar los componentes coloreados / A remoção de componentes coloridos é necessária para a construção posterior / La rimozione dei componenti colorati è necessaria per la costruzione successiva / Удаление цветных компонентов необходимо для дальнейшего строительства / 为进一步施工，需要拆除有色部件

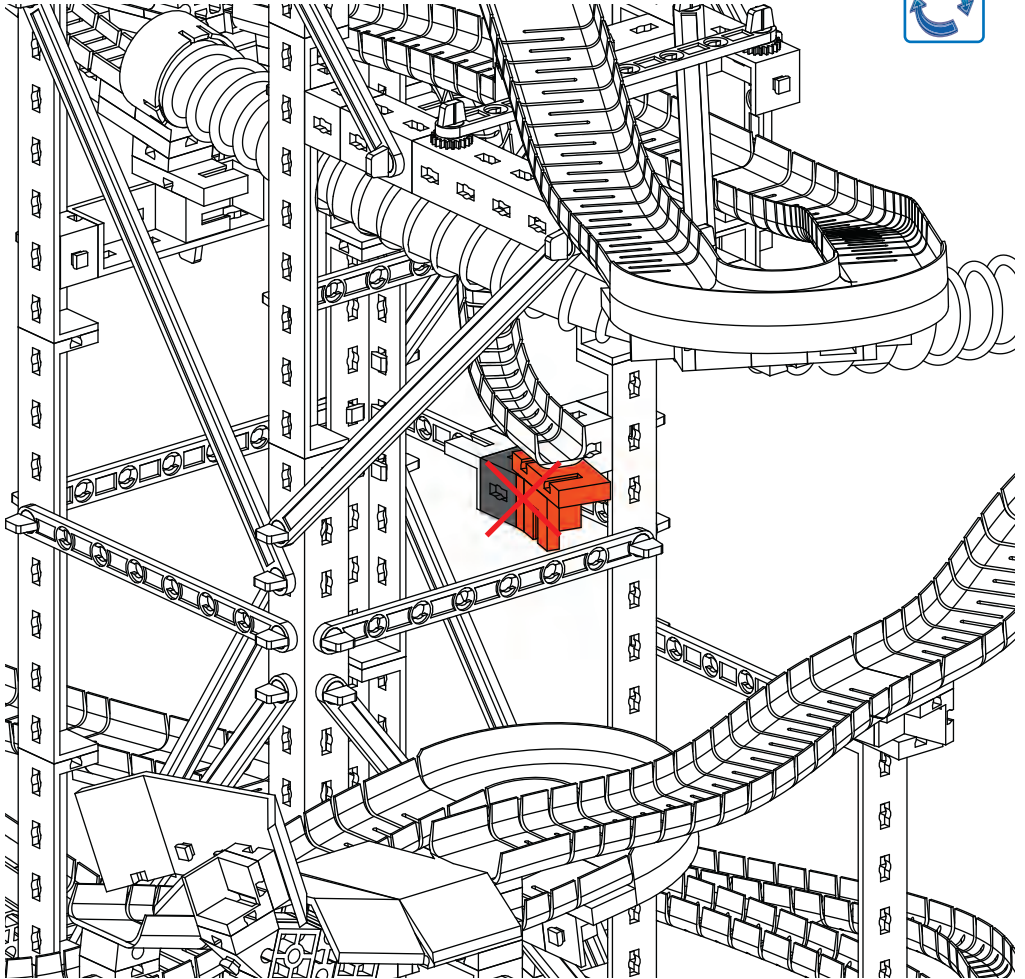





2



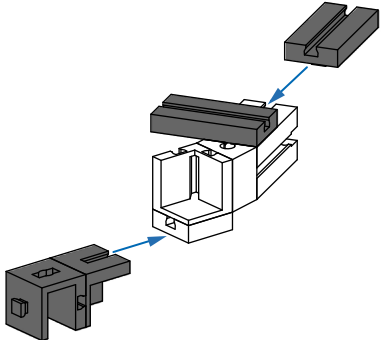
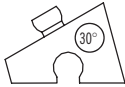
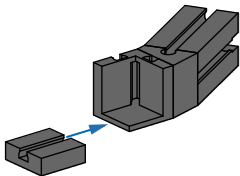



Farbige Bauteile ausbauen, werden beim weiteren Bauen benötigt / Removing colored components is required for further construction / Démontez les éléments colorés, ils seront nécessaires pour la suite de la construction / Verwijderen van gekleurde onderdelen is nodig voor verdere constructie / Para seguir construyendo es necesario retirar los componentes coloreados / A remoção de componentes coloridos é necessária para a construção posterior / La rimozione dei componenti colorati è necessaria per la costruzione successiva / Удаление цветных компонентов необходимо для дальнейшего строительства / 为进一步施工，需要拆除有色部件

**3**  1x  1x  1x  1x

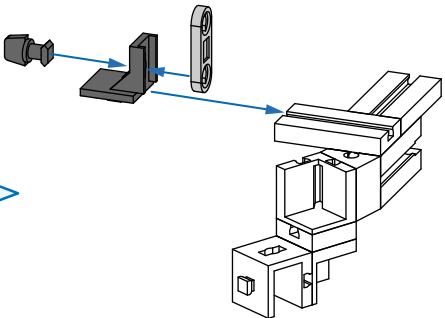

**4**  1x  2x  1x



**5**  1x  1x  1x

**6**

1x [Blue Technic Beam 1x5 with 2 holes]

2x [Black Technic Pin]

1x [Black Technic Pin]

1x [Red Technic Pin]

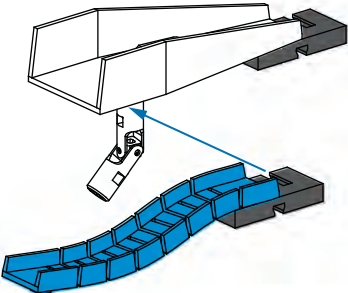
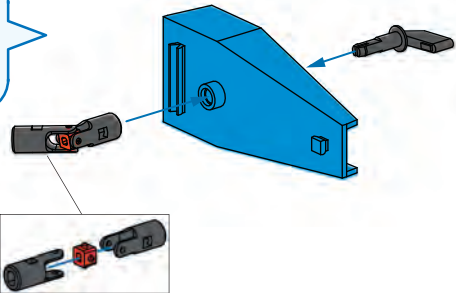

**7**

1x [Blue Technic Beam 1x10 with 9 holes]



2x [Black Technic Pin]

**8**



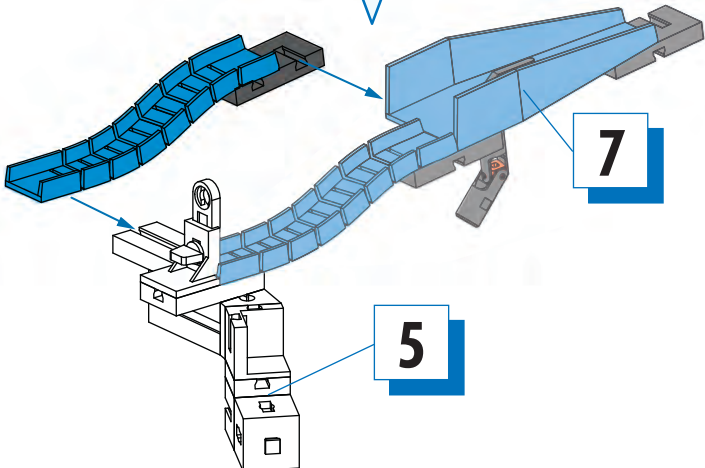





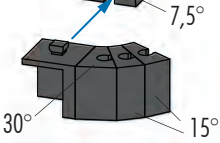
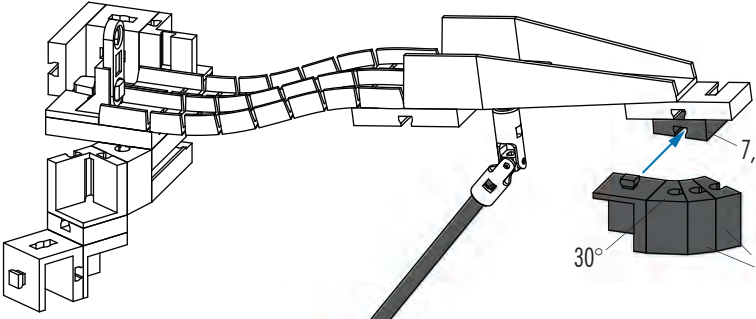
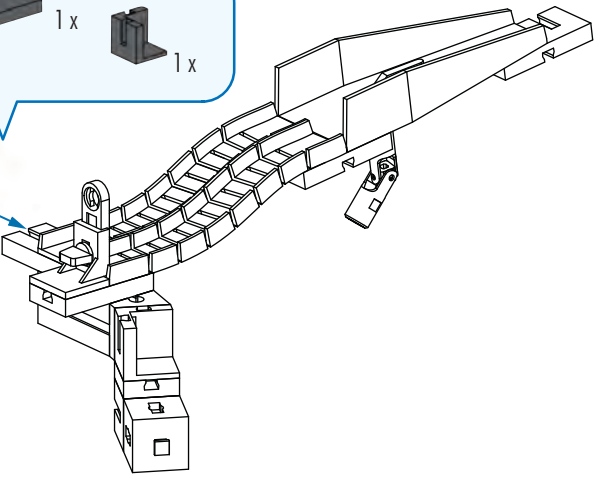
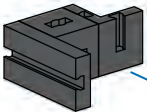

1x [Blue Technic Beam 1x10 with 9 holes]

1x [Black Technic Pin]





- 9**  1x  1x  1x



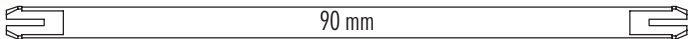
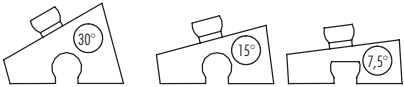

- 10**  1x  1x  2x  1x  1x  2x  1x  2x  1x  1x

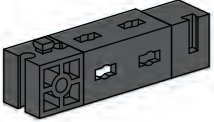

- 11**  1x  1x  1x

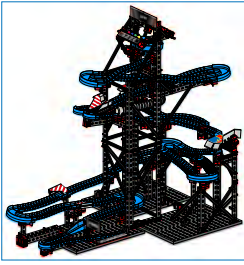



12  1x

Race Track 1

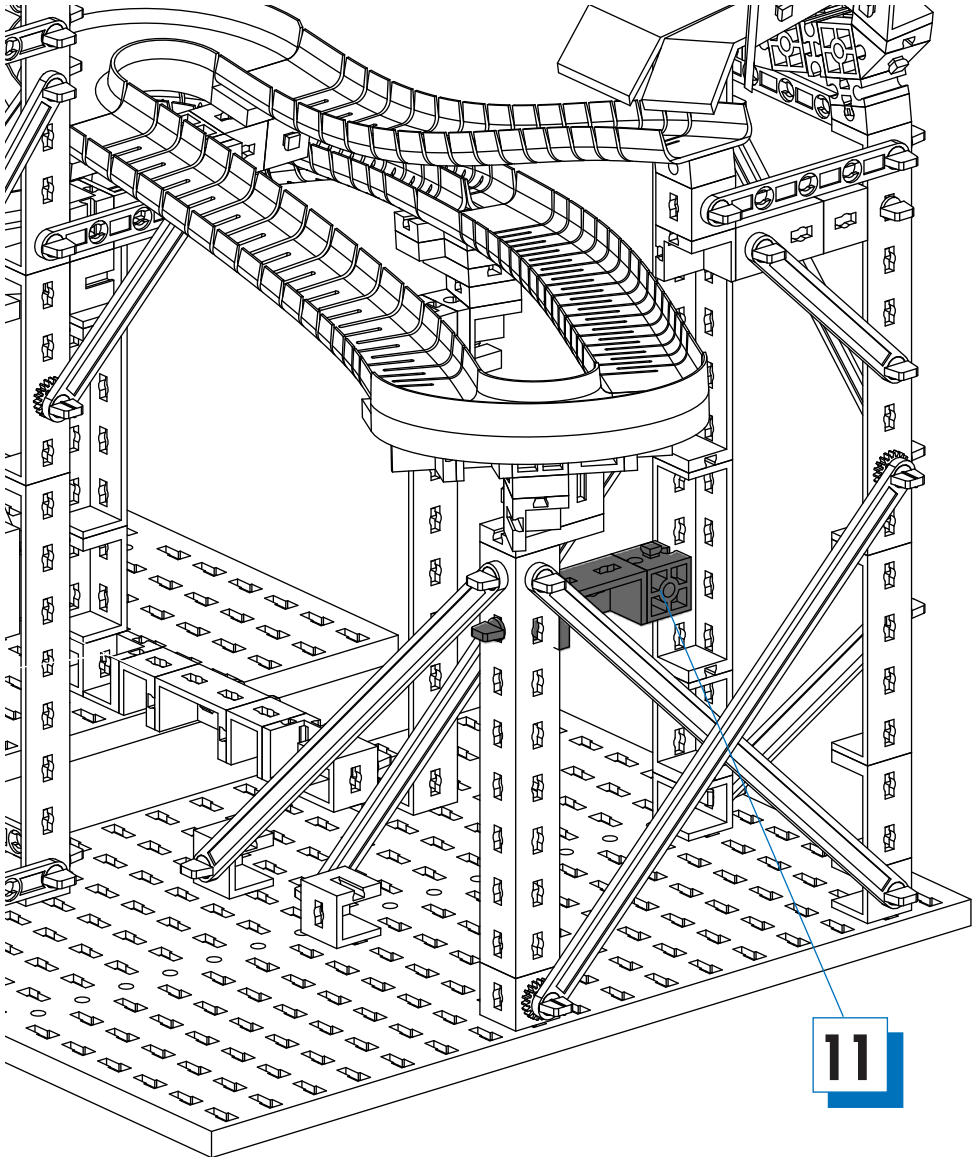

11

13



12

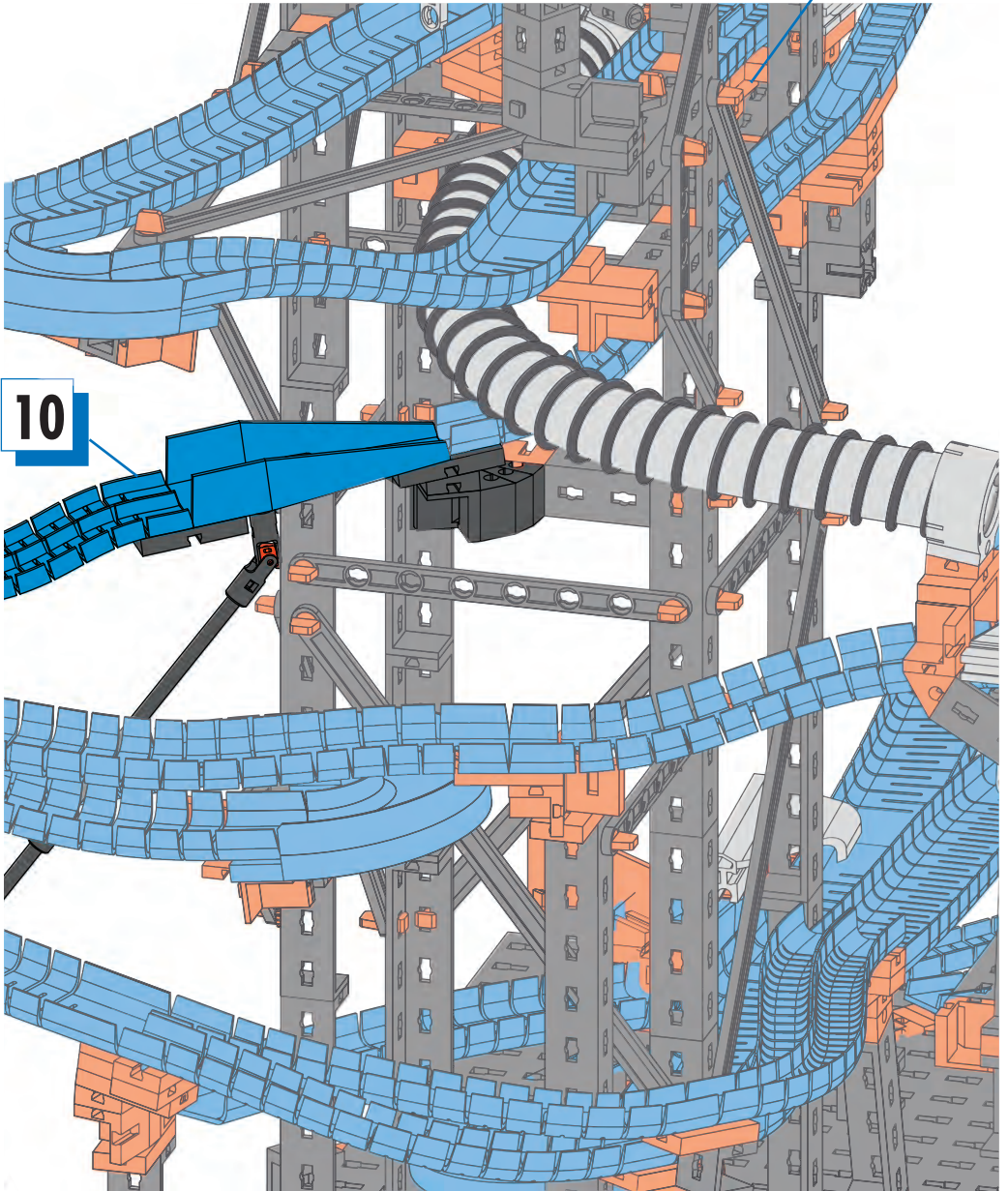

10



14



13

10

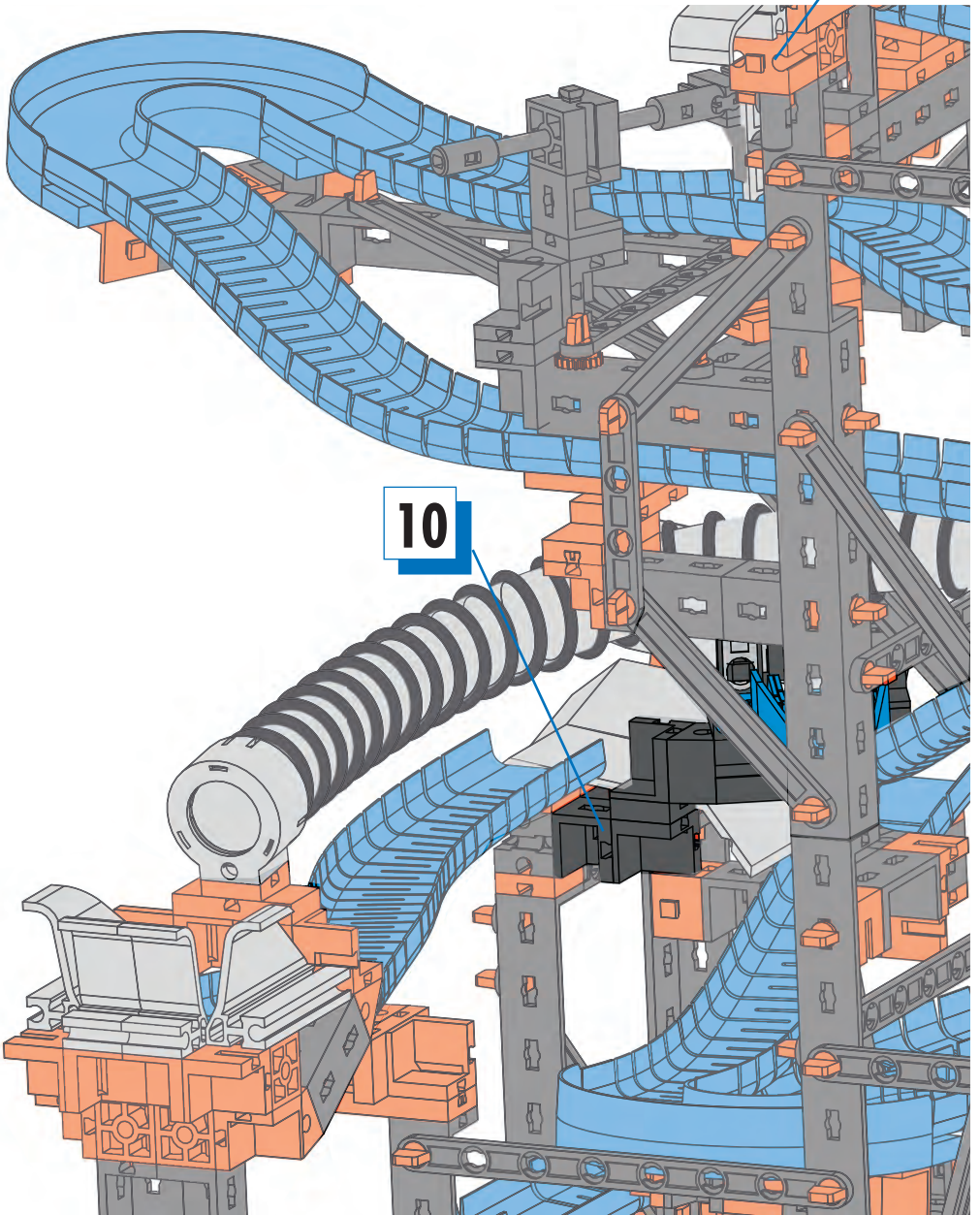

**15**  60 1x  
60 1x

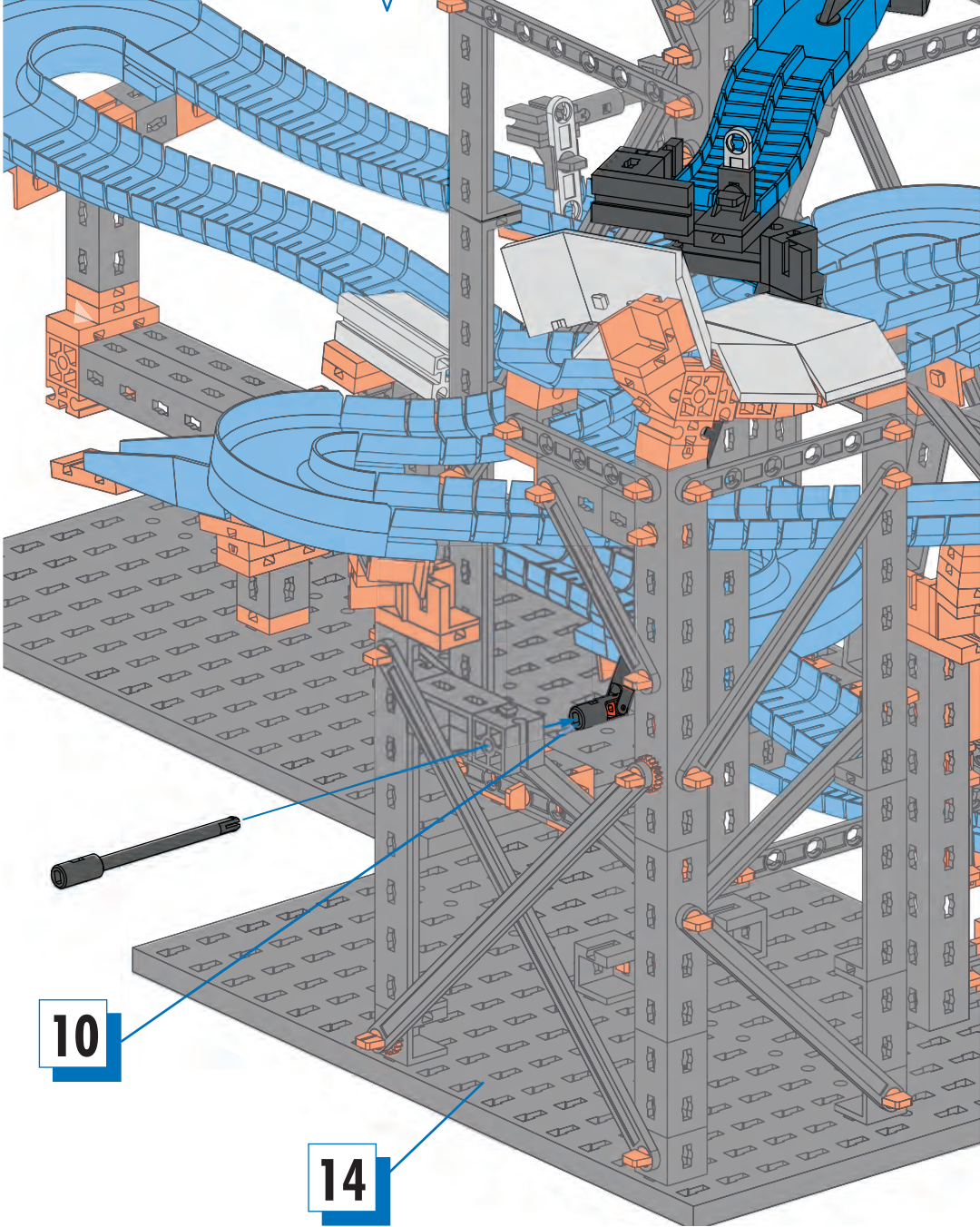

**10**

**14**

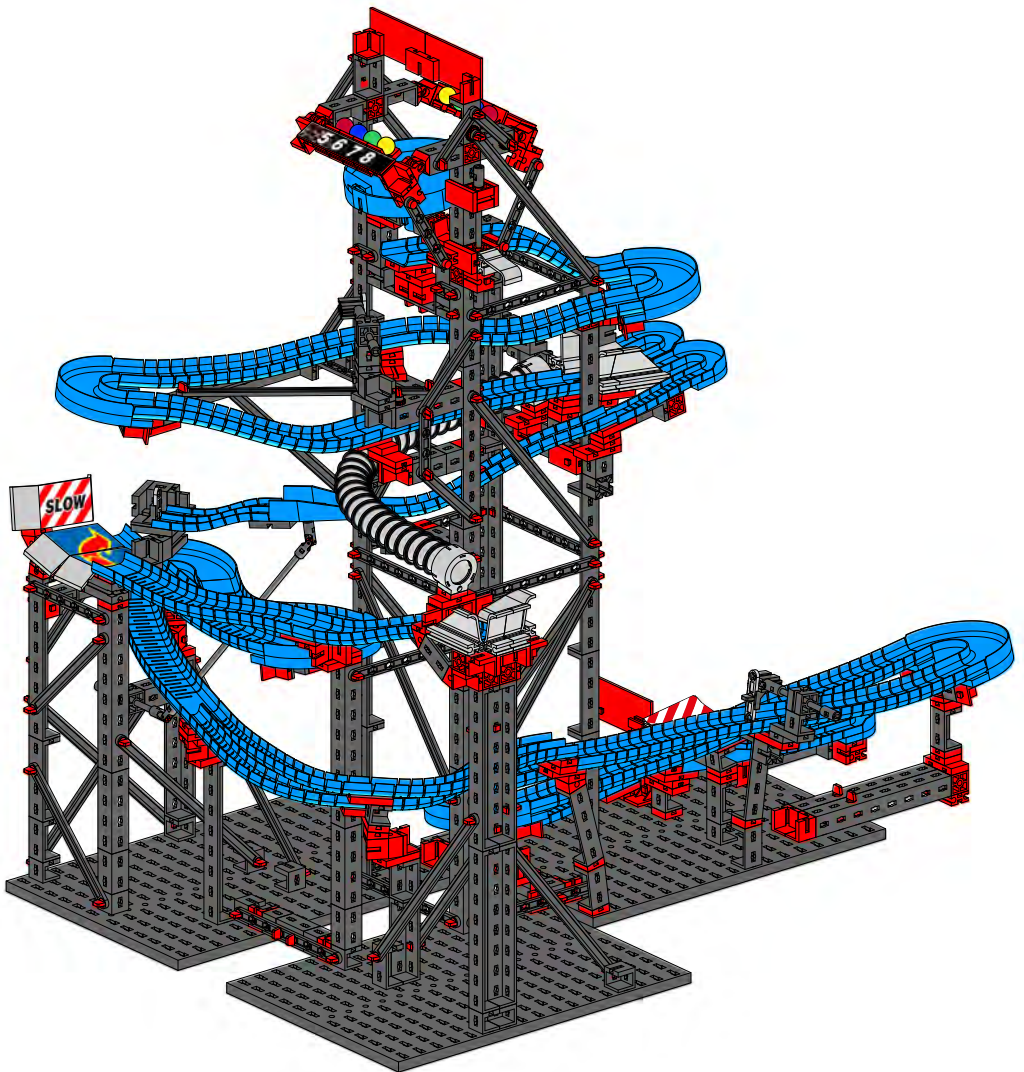

Modell in Action! / Model in action! / Modèle en service! / Model in actie! /  
¡El modelo en acción! / Modelo em ação! / Il modello in azione! /  
Модель в действии! / 模型制作演示! :

<http://www.fischertechnik.de/e-learning/marble-competition-battle>

