

FAN-CLUB



Die Baukastenbasis für Sommerzeit – Solar-Zeit Fan Club Modell „Sun Racer“

Das Modell Sun Racer ist gebaut aus dem Baukasten Profi Solar und einigen Zusatzteilen wie z. B. einem zweiten Solarmodul (siehe auch Stückliste). Das zweite Solarmodul wird parallel zum ersten geschaltet. Dabei muss man, wie in der Anleitung beschrieben, etwas tricksen, aber mit zwei Büroklammern, die geradegebogen werden, oder einem Stück Draht in ähnlicher Stärke geht es problemlos.

Wird der Solar-Motor wie bei diesem Modell über zwei Solarmodule gespeist, kommt er bereits bei wenig Licht auf Touren, der Goldcap wird noch schneller aufgeladen und selbst der Antrieb des großen Speichenrads stellt kein Problem dar.

Bei Sonnenschein und auf Asphalt geht bei diesem Modell dann richtig die Post ab.

Übrigens, die zusätzlichen Teile, die in der Stückliste separat aufgeführt sind, kann man wieder als „Zusatzbeutel Sun Racer“ über den Einzelteil-Service beziehen.



Nr. 14
ZUM SAMMELN





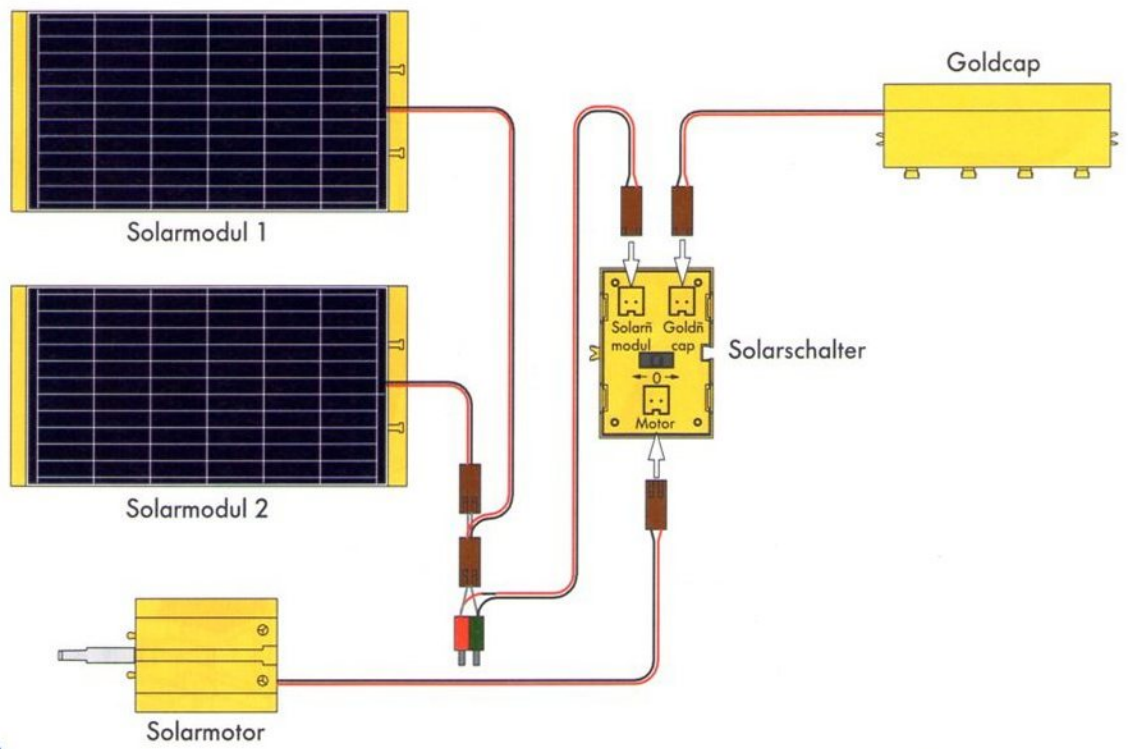

fischertechnik[®]



Schaltplan

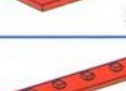

Einzelteilübersicht

| | | | | | | | | | |
|---|----|---|----|---|----|---|----|---|----|
|  | 2x |  | 1x |  | 1x |  | 1x | Zusätzliche Teile | |
|  | 1x |  | 1x |  | 1x |  | 1x | | |
|  | 4x |  | 1x |  | 1x |  | 1x |  | 1x |
|  | 1x |  | 2x |  | 4x |  | 1x |  | 1x |
|  | 2x |  | 2x |  | 2x |  | 2x |  | 1x |
|  | 1x |  | 3x |  | 1x |  | 4x |  | 4x |
|  | 1x |  | 4x |  | 1x |  | 2x |  | 1x |
|  | 1x |  | 2x |  | 2x |  | 1x |  | 1x |
|  | 1x |  | 1x |  | 2x |  | 3x |  | 1x |
|  | 2x |  | 2x |  | 1x |  | 4x |  | 1x |
|  | 2x |  | 2x |  | 4x |  | 1x |  | 1x |
|  | 1x |  | 1x |  | 1x | | | | |
|  | 3x |  | 2x |  | 1x | | | | |

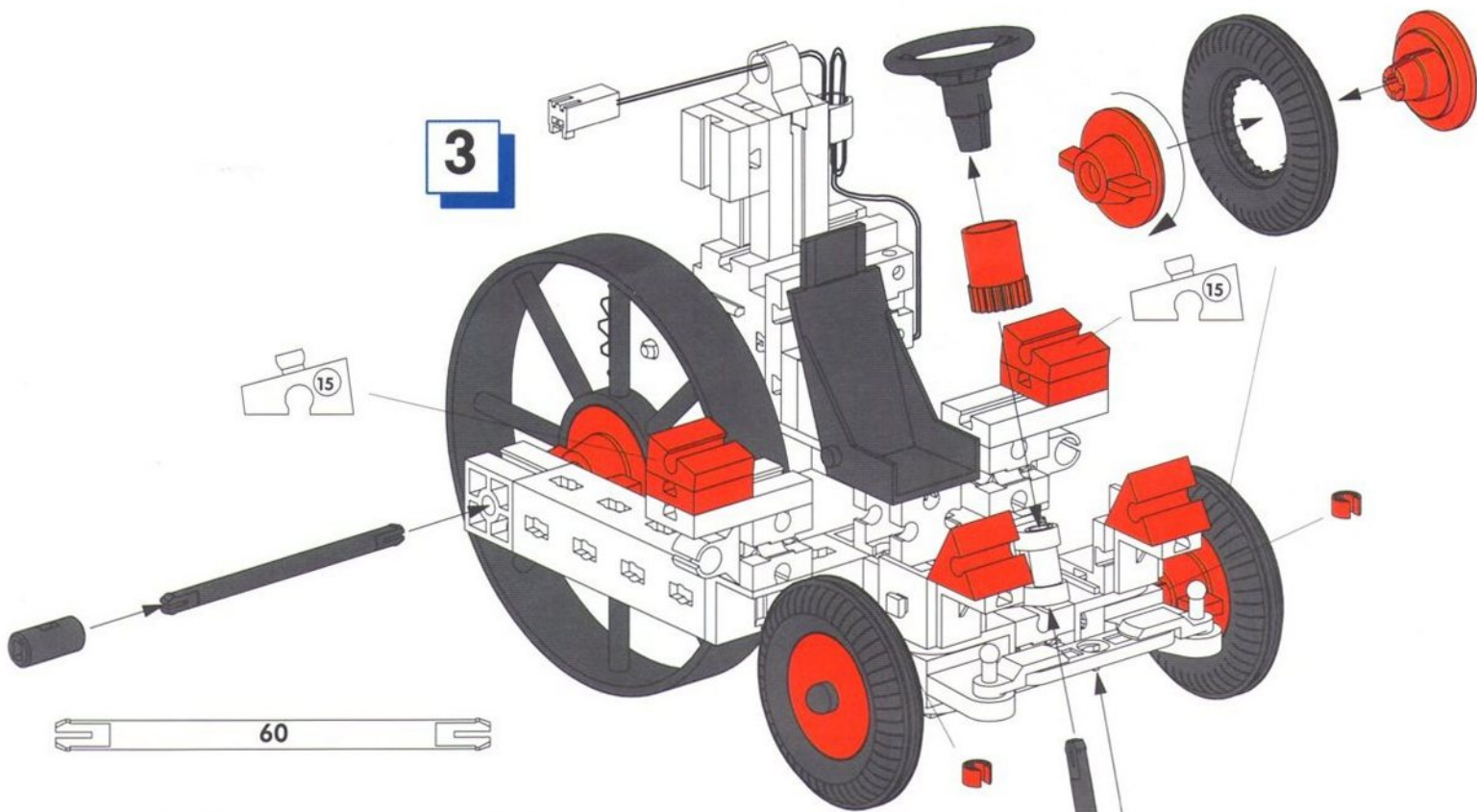

Parallelschaltung von 2 Solarmodulen

Draht oder aufgebogene Büroklammer
je 35 mm lang

