

NR. 31

Zum Sammeln

**Fan Club Modell
RC Greifer-Scorpion**

Der Greifer-Scorpion wird aus dem neuen RC Car Set in Kombination mit dem Universal II gebaut. Mit dem Fan Club Modell könnt ihr aus sicherer Entfernung per Funkfernsteuerung verschiedene Gegenstände greifen bzw. fangen. Wenn der Scorpion einen Gegenstand mit seinem „Maul“ berührt, schnappen die Greifzangen blitzschnell zu. Greifzangen wieder auseinanderdrücken, schon ist der Scorpion wieder einsatzbereit. Viel Spaß beim Zusammenbau!



1

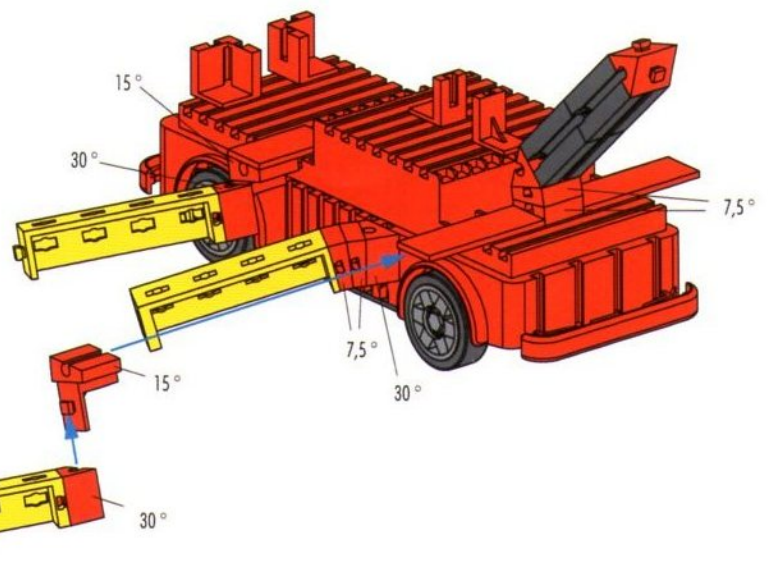

2

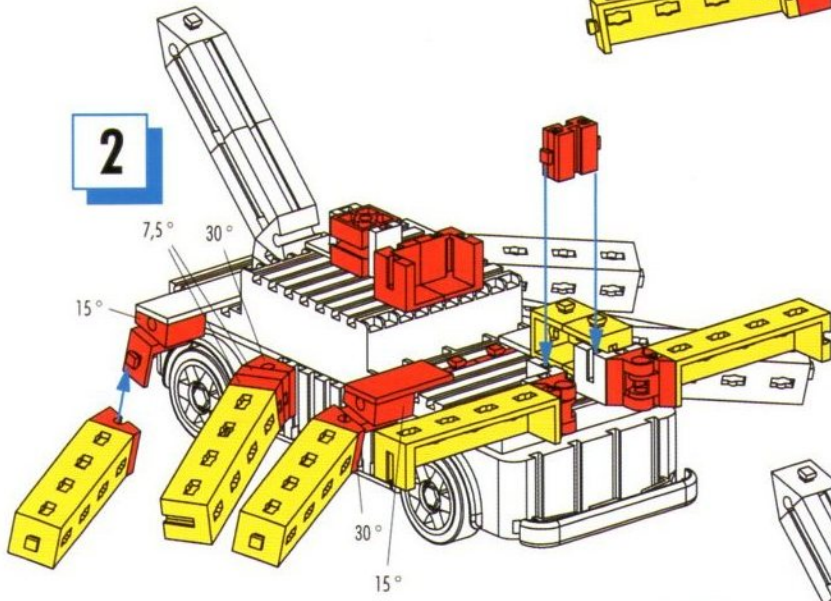

3

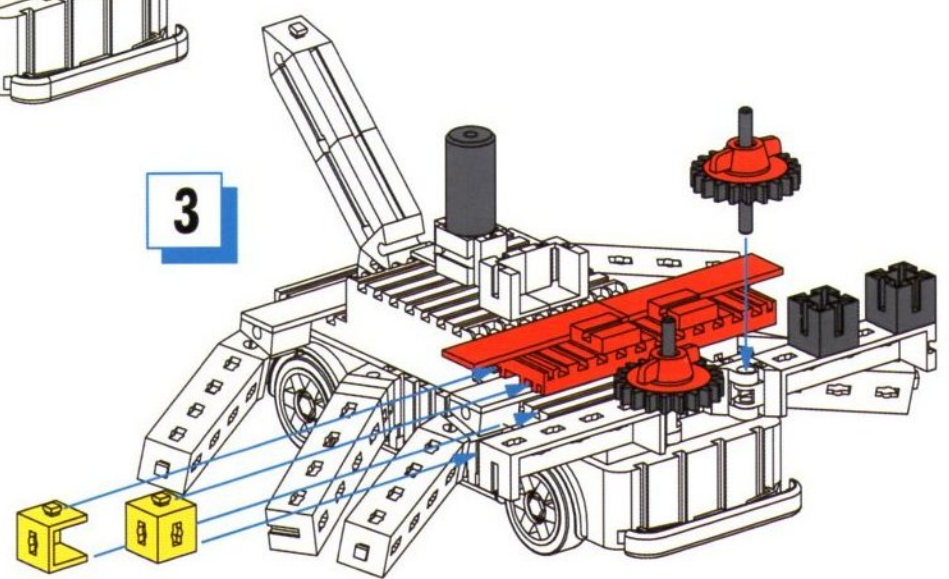

4

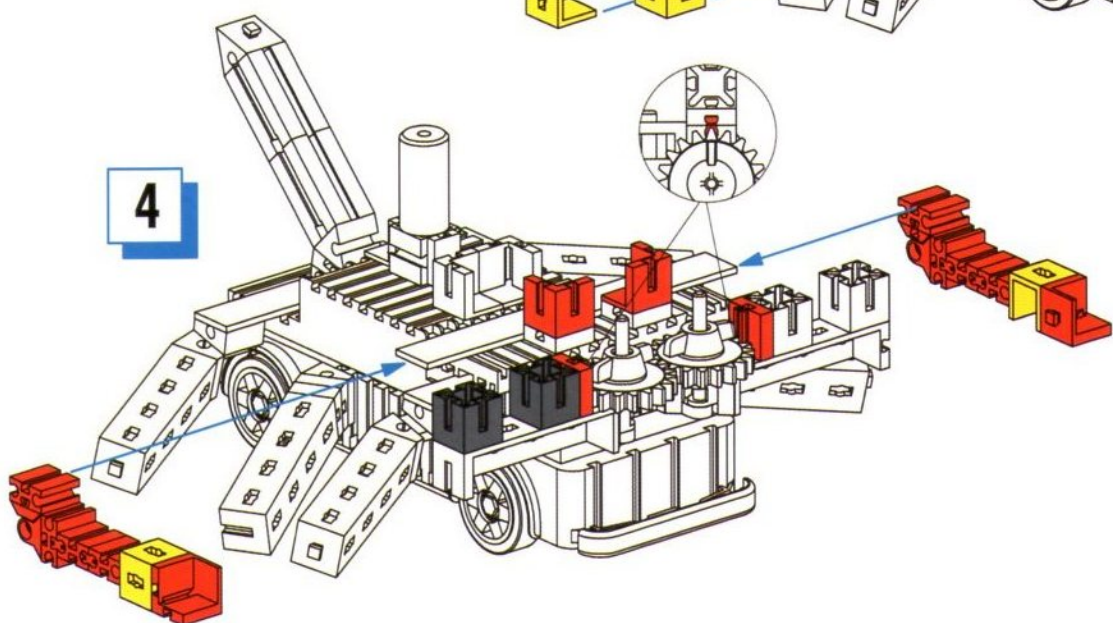

5

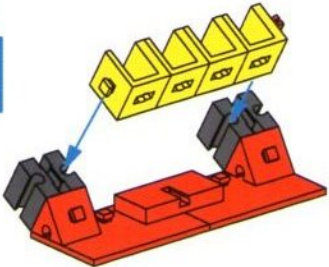

6

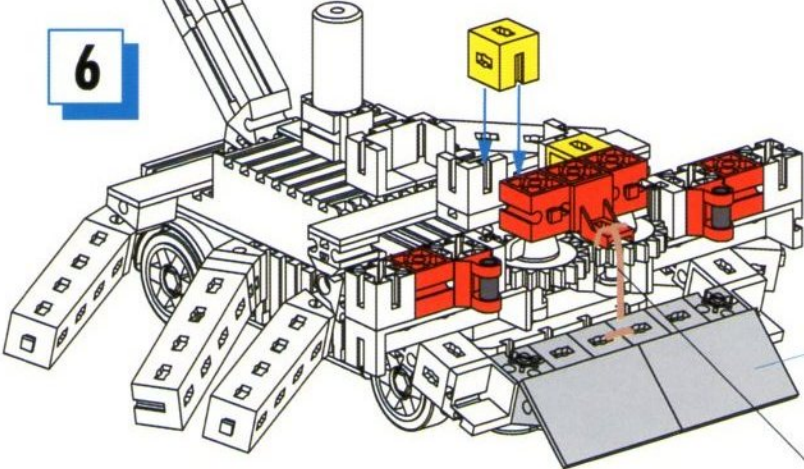

5

Haushaltsgummis; eventuell durch Verknoten spannen!

7

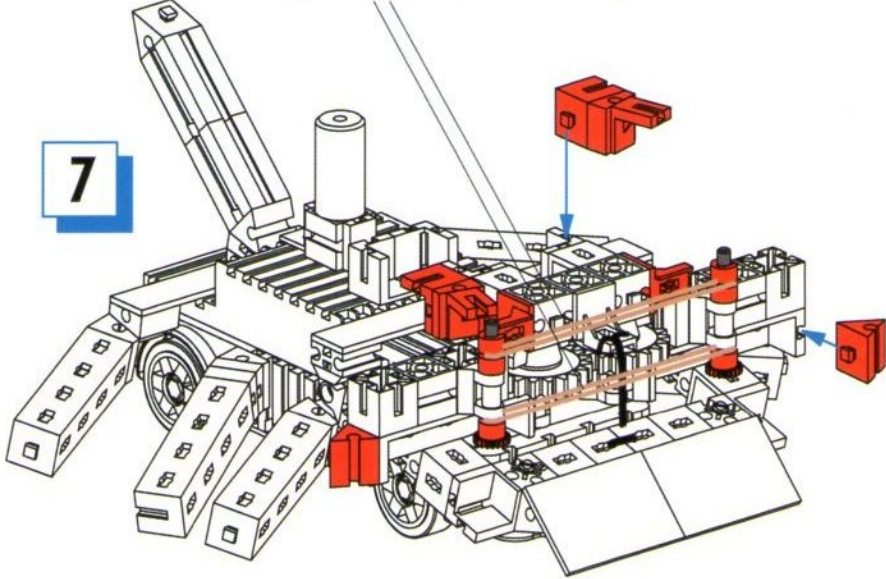



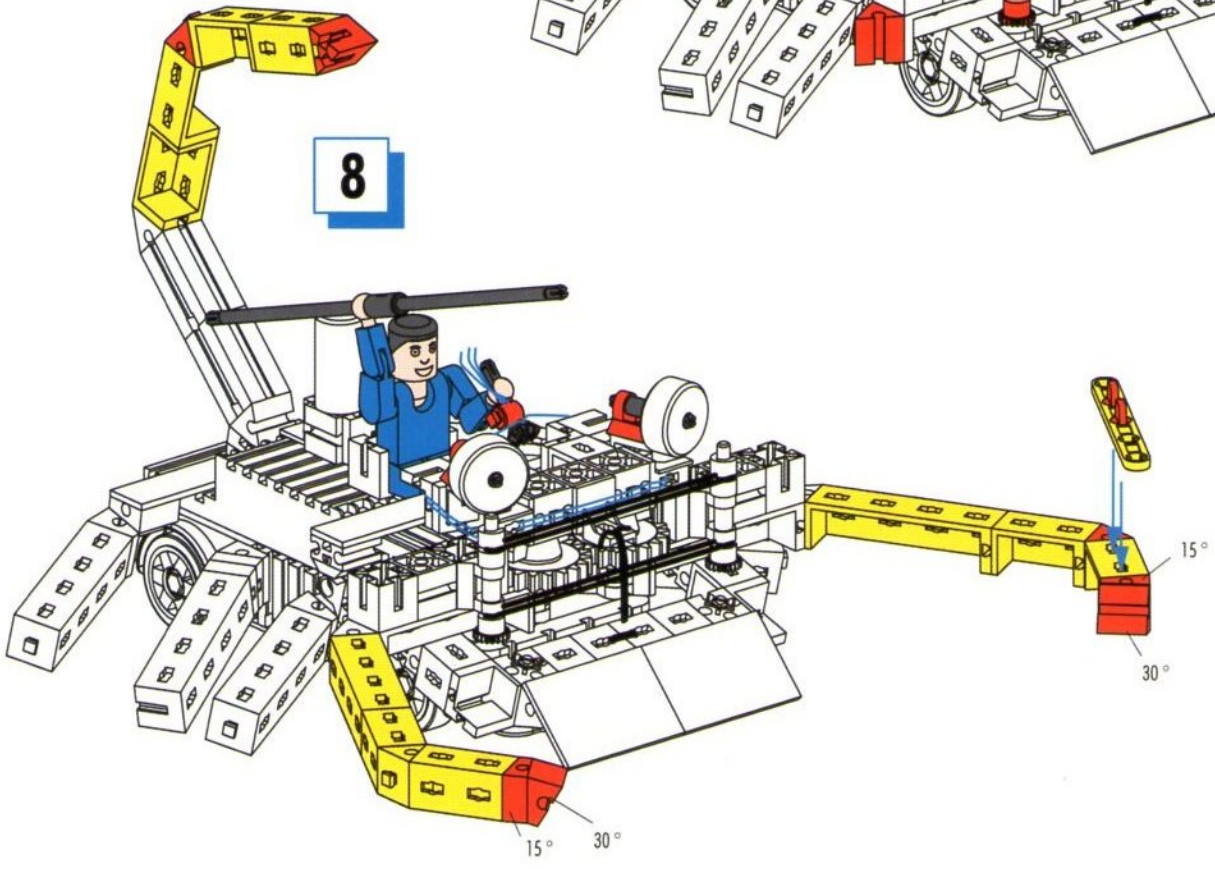

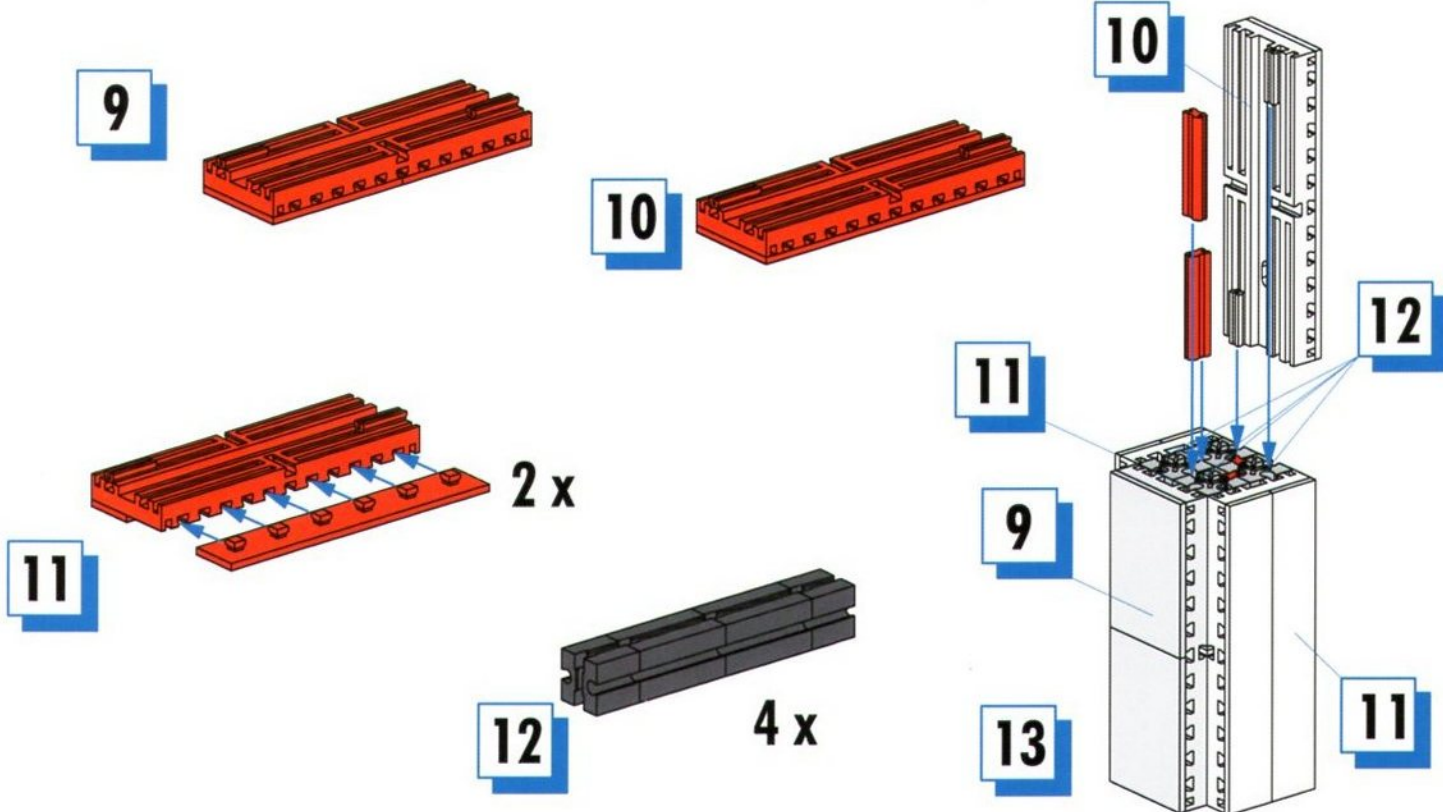



























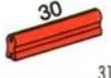









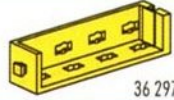







8





Einzelteilübersicht

 60° 31 010	9 x		17 x		2 x		2 x		1 x
 30° 31 011	8 x		6 x		6 x		4 x		4 x
	2 x	 7,5° 32 071	6 x		1 x		1 x		8 x
	2 x		4 x		2 x		4 x		1 x
 15° 31 060	4 x		1 x		2 x		9 x		2 x
 30° 31 061	4 x				1 x		6 x		1 x
	4 x		5 x		1 x		10 x		1 x
	8 x		1 x		10 x		2 x		128 171
	3 x		10 x		6 x		2 x		3 x
	1 x		10 x		8 x		4 x		
 15° 31 981	8 x		2 x		2 x		4 x		