

# NR. 34

Zum Sammeln













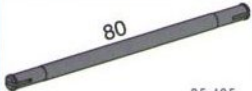











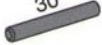







## Fan Club Modell Trike mit Anhänger

Dieses Trike mit Anhänger eignet sich bestens für Expeditionen und Erkundungstouren. Das nötige Equipment oder anderes Ladegut könnt ihr einfach und sicher auf dem Einachs-Anhänger verstauen. Ohne den Anhänger ist das Trike noch wendiger und schafft es mit den Geländereifen über beinahe jedes Hindernis. Für den Bau des Modells benötigt ihr die beiden Baukästen BASIC Carts und BASIC Bikes. Wir wünschen euch viel Spaß beim Bauen!

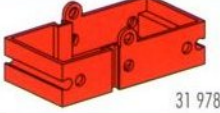

7  
BAUANLEITUNG

## Einzelteilübersicht

 31 010	3 x	 31 982	7 x	 35 405	1 x	 38 241	2 x
 31 011	7 x	 31 984	1 x	 35 977	2 x	 38 242	4 x
 31 426	2 x	 32 879	1 x	 36 227	2 x	 38 246	1 x
 31 436	3 x	 32 881	6 x	 36 334	4 x	 38 413	1 x
 31 597	2 x	 34 994	1 x	 36 819	1 x	 78 727	4 x
 31 848	4 x	 34 995	1 x	 36 913	2 x	 106 767	4 x
 31 918	1 x	 35 063	1 x	 36 950	1 x		
 31 978	1 x	 35 073	2 x	 37 468	6 x		
 31 981	3 x	 35 087	1 x	 38 240	4 x		

1

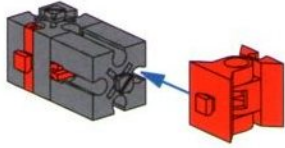

2

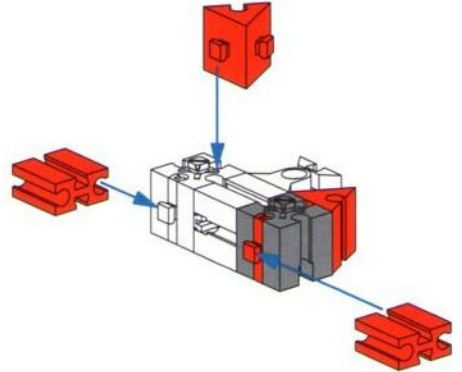

3

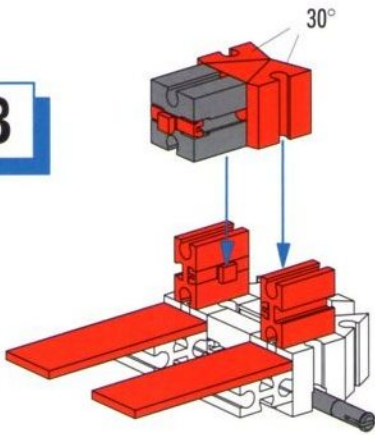

4

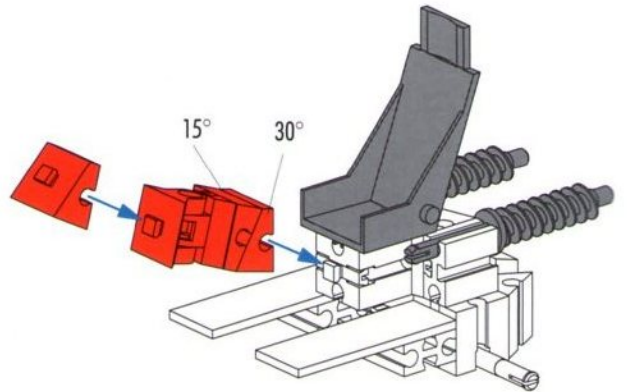

5

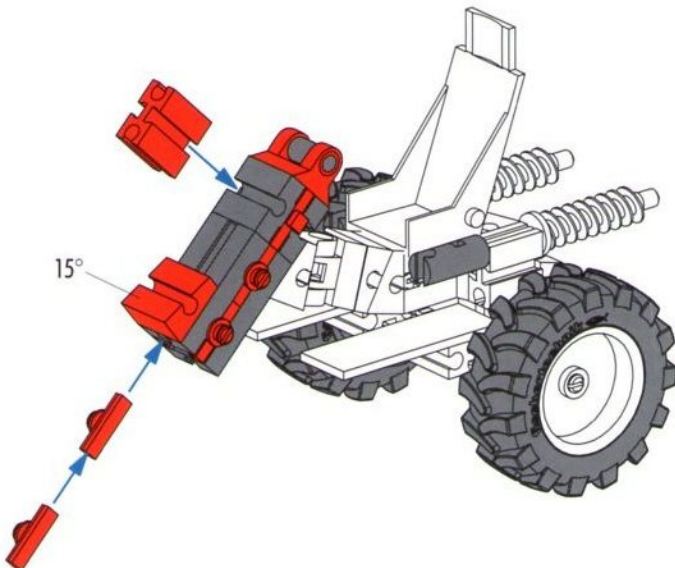

6

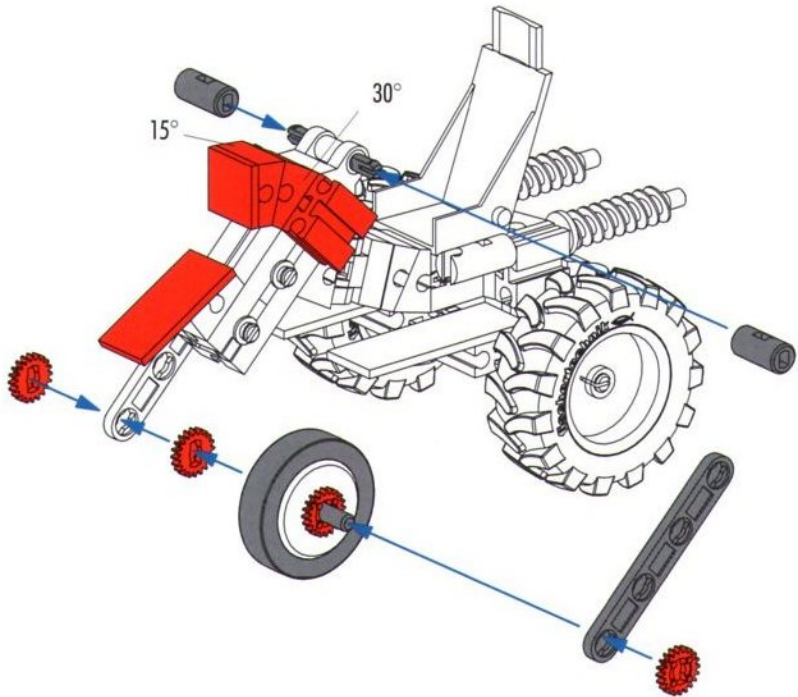

7

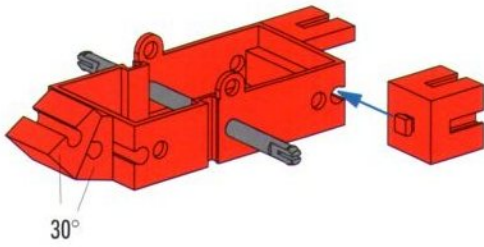

8

