



7
BAUANLEITUNG

NR. 41

Zum Sammeln

FAN CLUB Modell
Windmühle mit Rückzugsmotor

Das aktuelle FAN CLUB Modell Windmühle kannst du aus den Bauteilen des neuen Baukasten PROFI Cars & Drives und ADVANCED Universal 3 konstruieren. Es wurde von **Tobias Ziefle** entwickelt. Er absolviert bei fischer eine Ausbildung zum Mechatroniker und ist im zweiten Lehrjahr. Tobias Ziefle erklärt dazu: „Aufgabenstellung war die Konstruktion eines Modells, bei dem der Rückzugsmotor als Antrieb dient. Es sollte aber

kein Fahrzeug entstehen und der Rückzugsmotor sollte pfiffig verbaut werden. Die ausgeklügelte Übersetzung sorgt dafür, dass sich die gespannte Feder des Motors langsam über einen langen Zeitraum entspannt. Dies ermöglicht einen über zweiminütigen Antrieb der Flügel“. Ihr findet sicherlich noch weitere ungewöhnliche Einsatzmöglichkeiten für den neuen Rückzugsmotor. Viel Spaß beim Bau des FAN CLUB Modells!

1

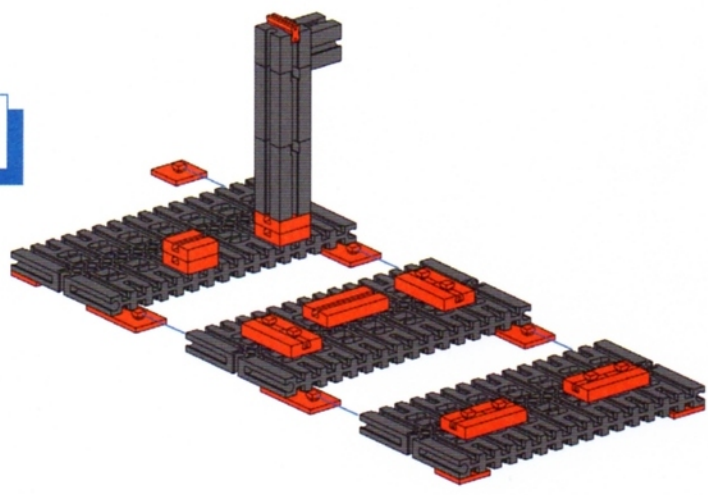

2

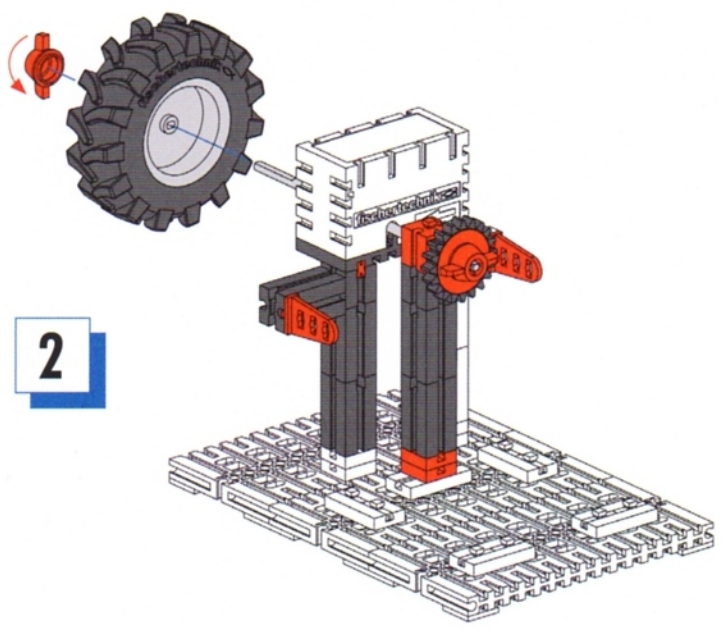

3

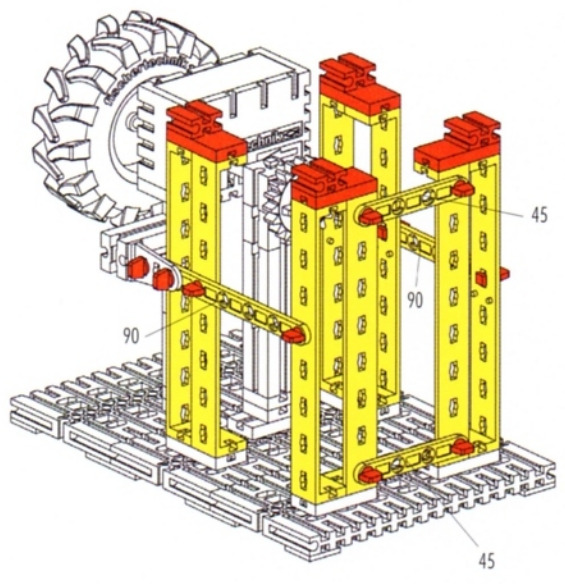

4

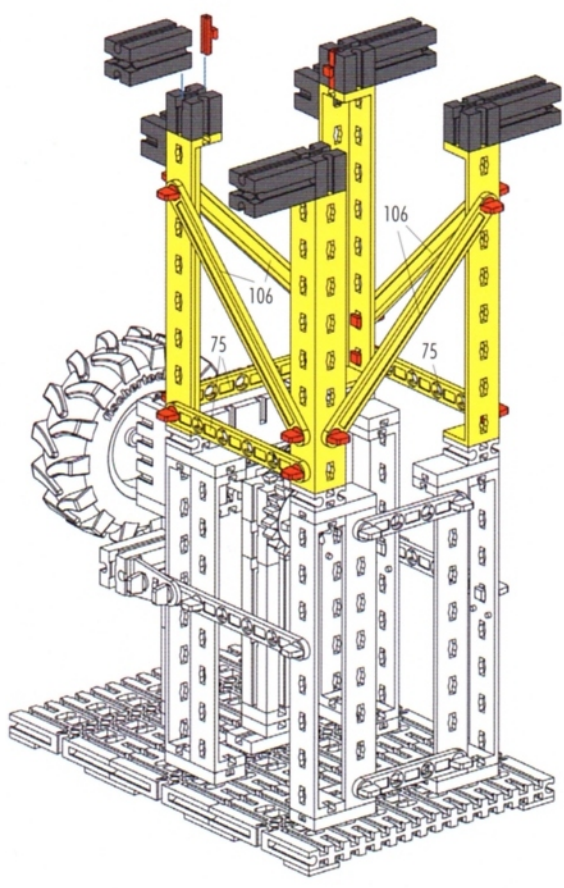

5

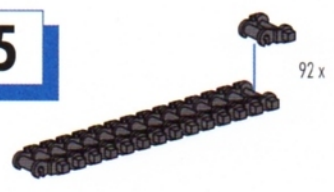

6

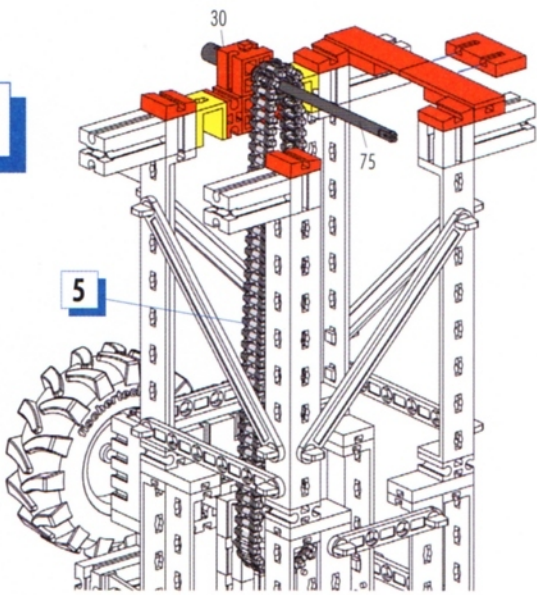

7

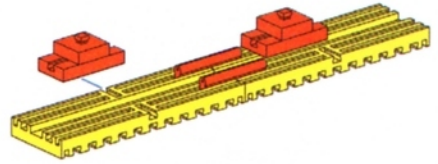

8

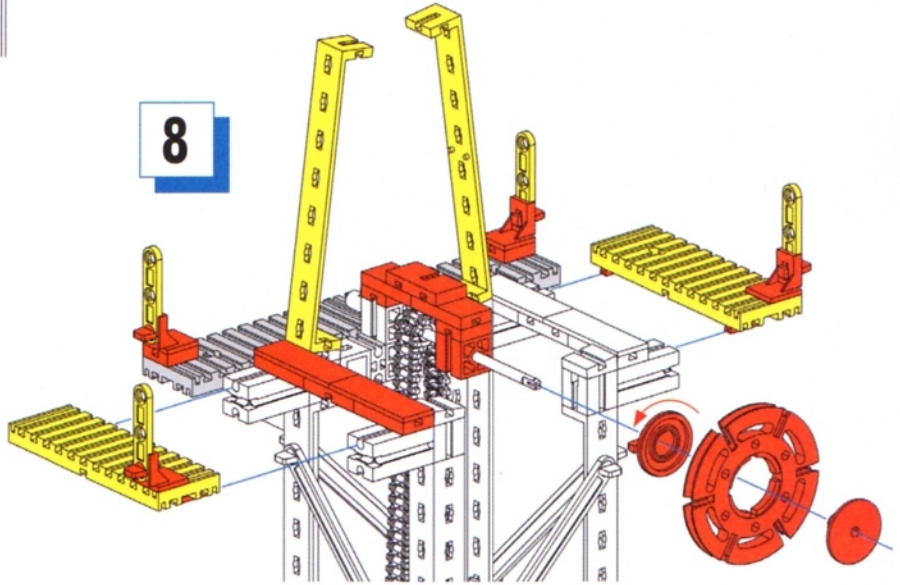

9

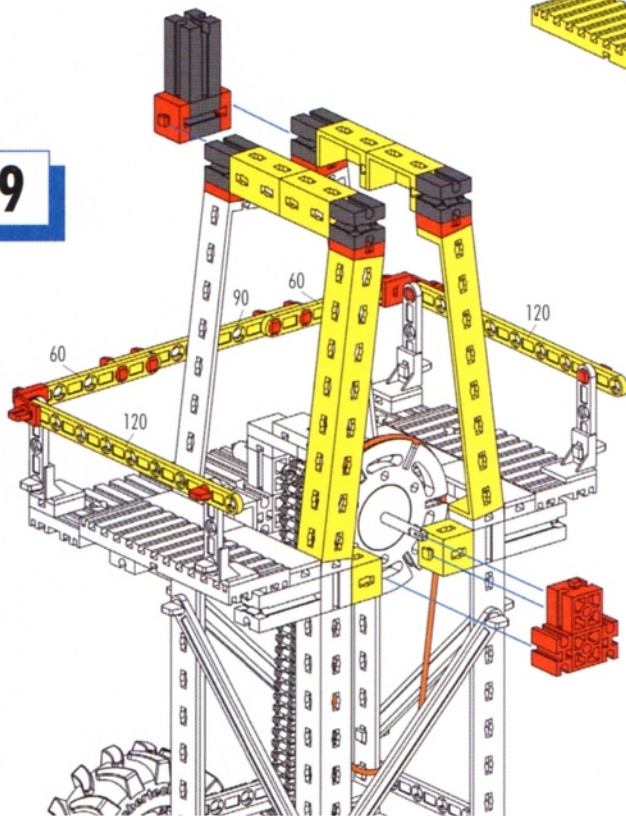

10

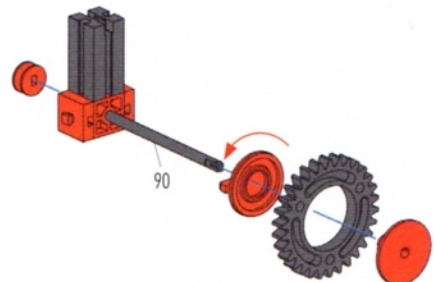

11

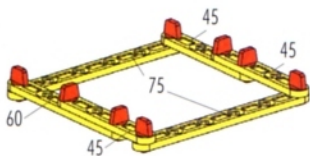

2 x

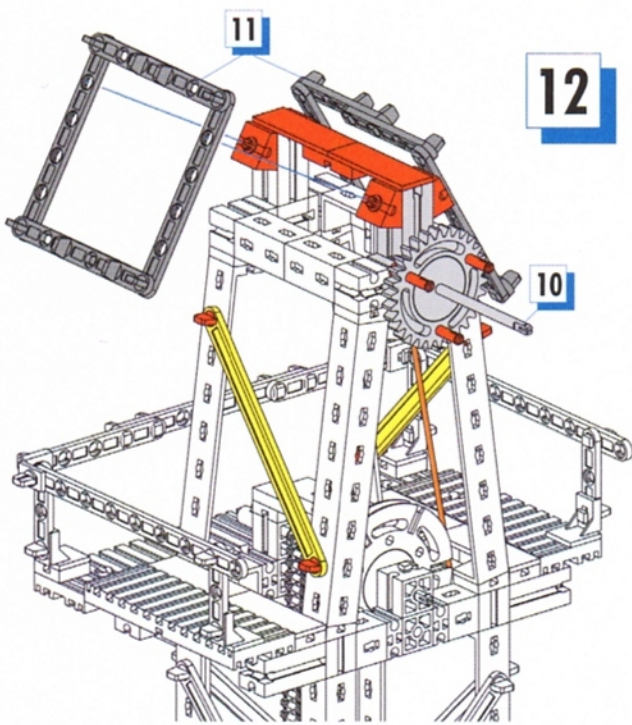





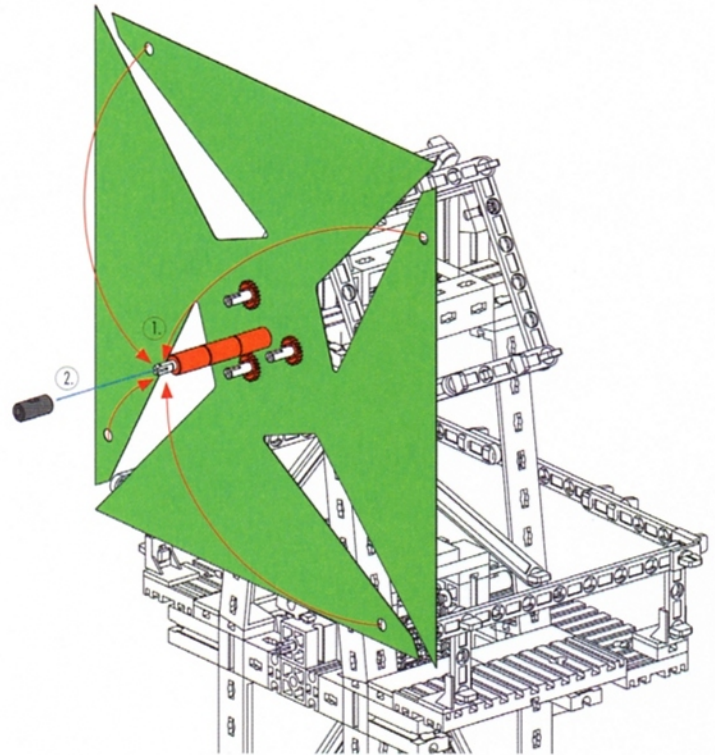























































12

13



Einzelteilübersicht
Spare parts list

	31 011		31 982		35 033		35 129		37 238		38 541
4x			18x		1x		3x		2x	8x	
	31 019		31 983		35 049		35 945		37 468		38 545
1x			3x		17x		1x		8x	7x	
	31 021		32 064		35 053		36 264		38 241		106 766
1x			7x		2x		1x		4x	1x	
	31 058		32 071		35 054		36 294		38 242		122 267
3x			8x		10x		6x		6x	1x	
	31 060		32 850		35 059		36 298		38 246		122 646
2x			2x		6x		2x		4x	1x	
	31 061		32 861		35 060		36 299		38 260		128 659
2x			4x		2x		4x		2x	1x	
	31 670		32 879		35 063		36 323		38 428		92x
2x			13x		1x		58x		4x	136 775	
	31 674		32 881		35 066		36 324		38 531		1x
4x			12x		1x		2x		3x	137 103	
	31 690		32 882		35 073		36 334		38 538		1x
3x			1x		2x		3x		4x	137 357	
	31 848		35 031		35 087		37 237		38 540		1x
4x			3x		1x		14x		4x		