

NO. 55

To collect

FAN CLUB model
Funny Machines extension

As we wrote earlier, Magnus Fox, our intern, developed the current Fan Club model for you. He combined the two building sets **ADVANCED Funny Machines** and **Universal 4**. This created a huge chain reaction, thanks to the large number of parts. The model is 1.6m long, with each action triggering a subsequent reaction.

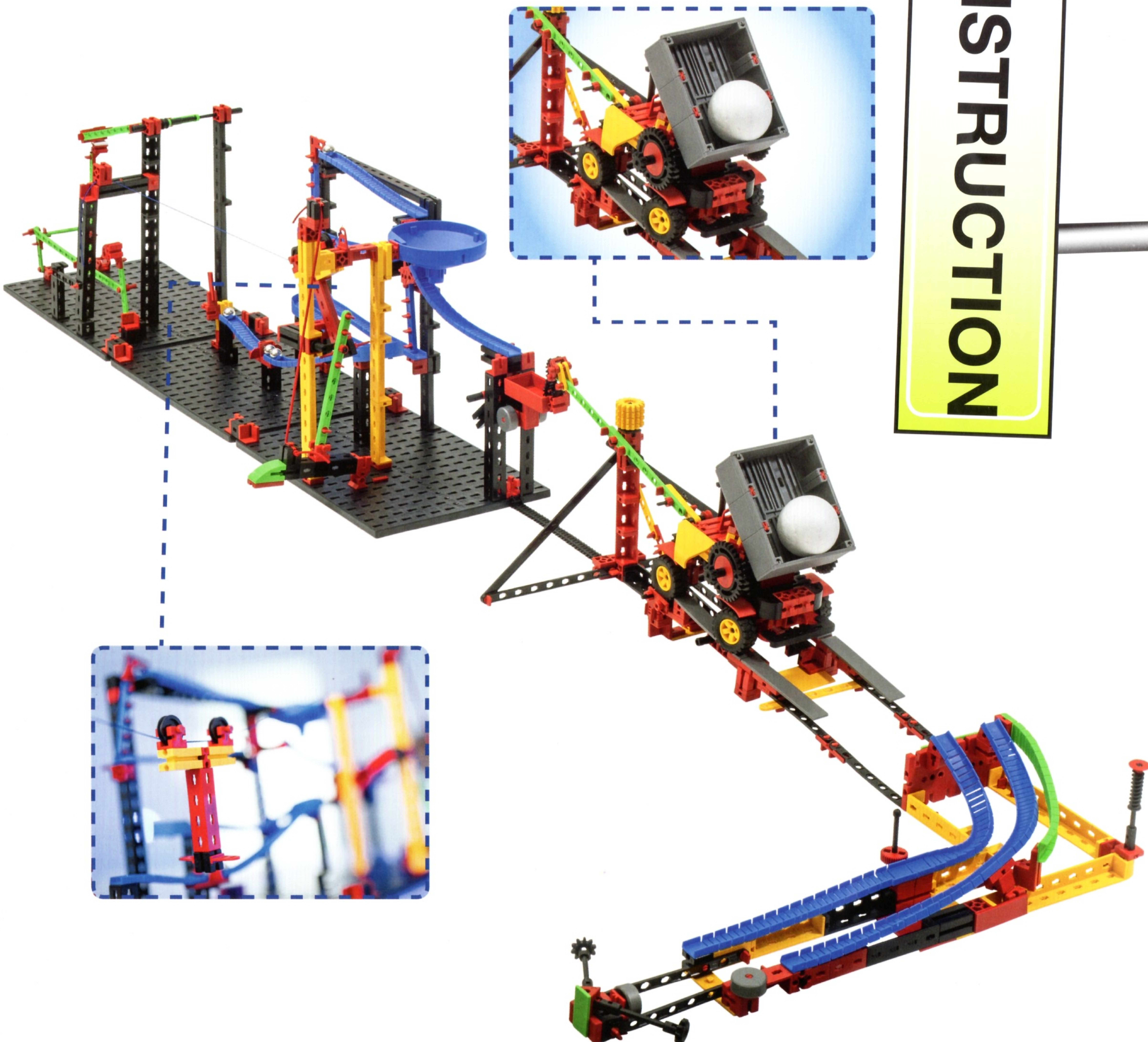

7

ASSEMBLY INSTRUCTION

Funny Machines Parcours 3

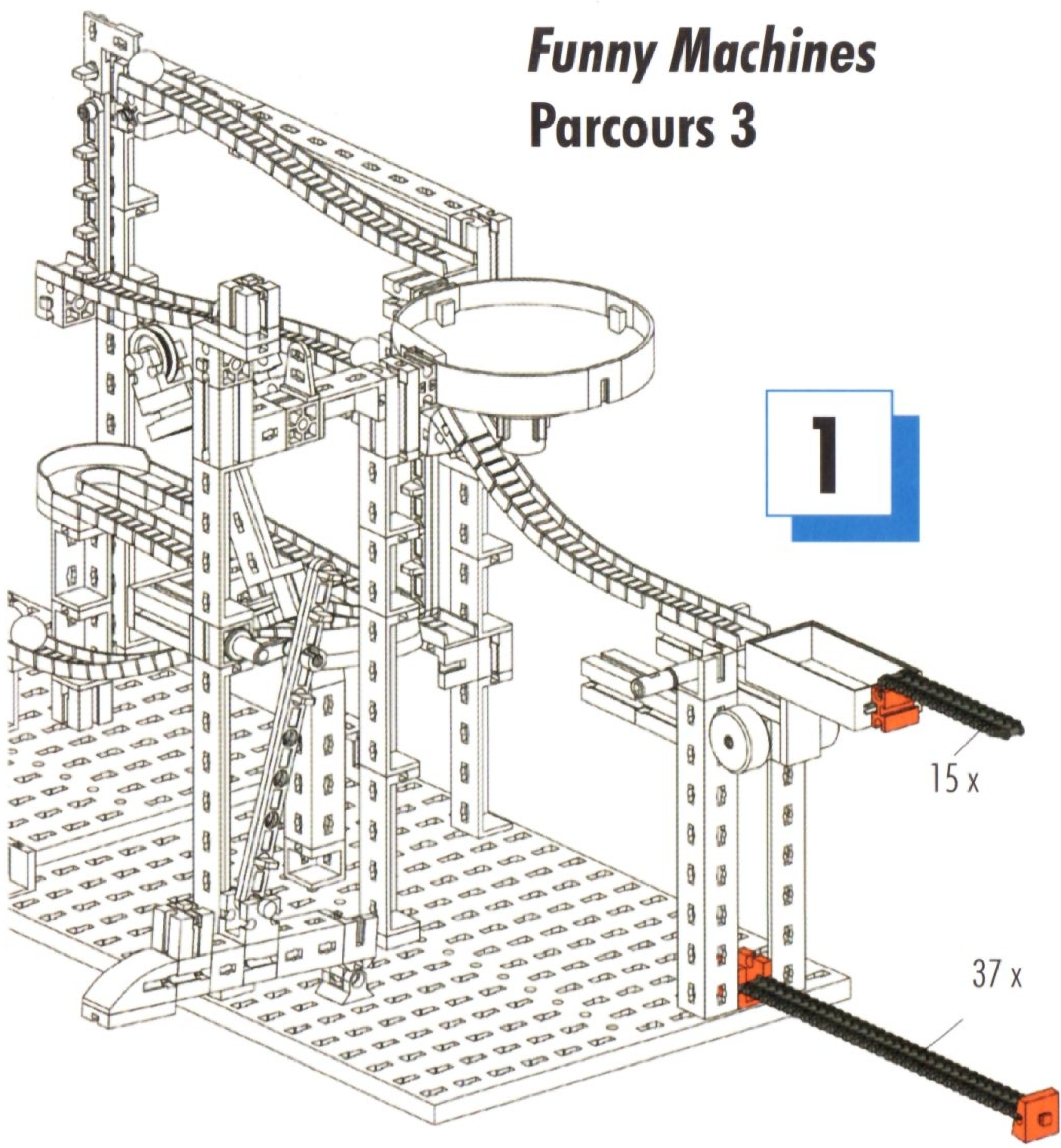

2

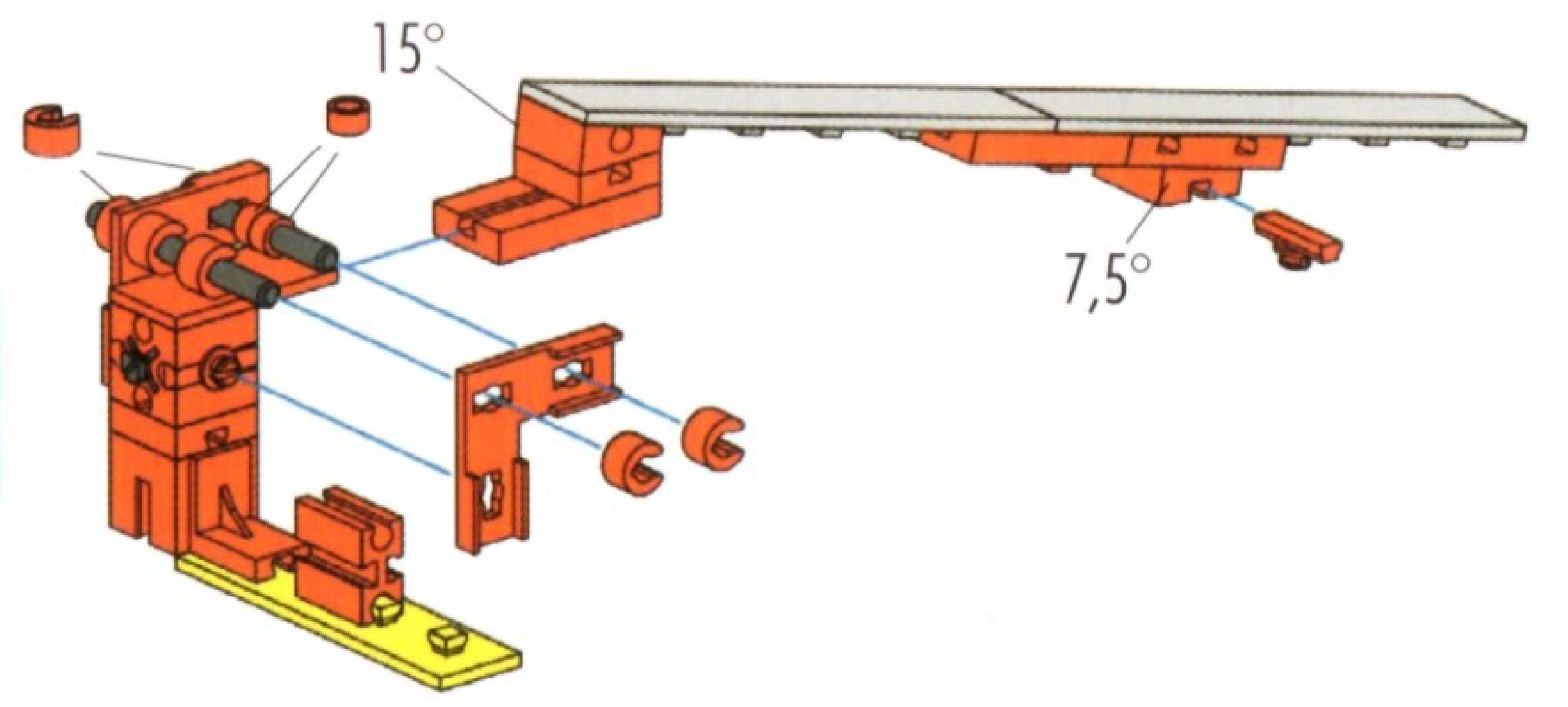

3

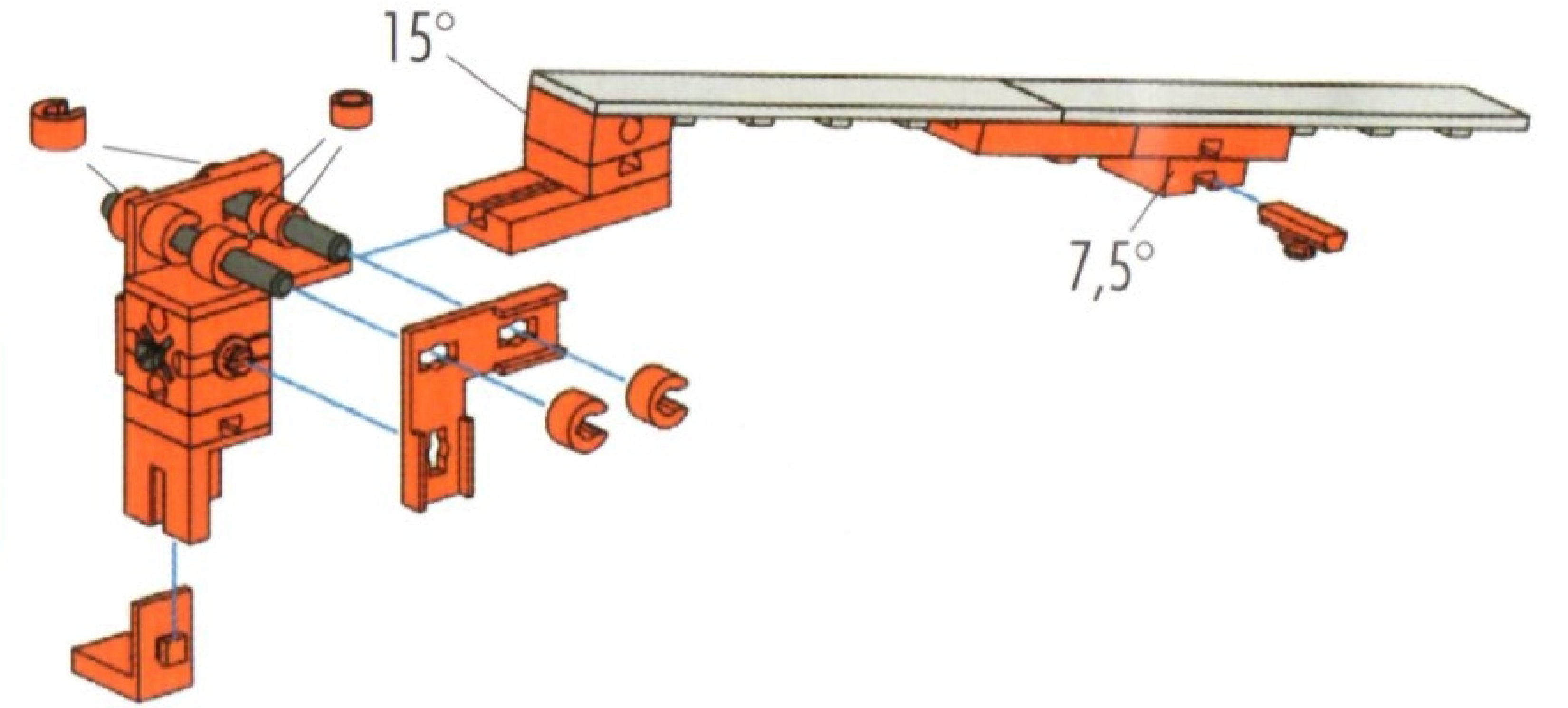

4

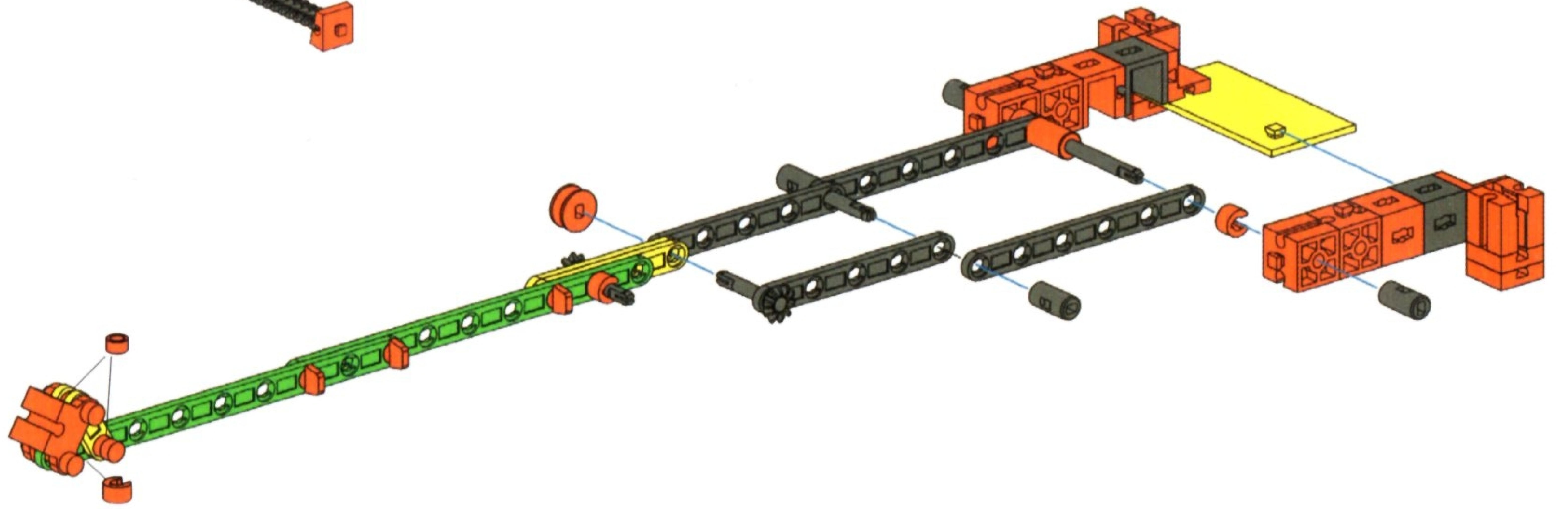

5

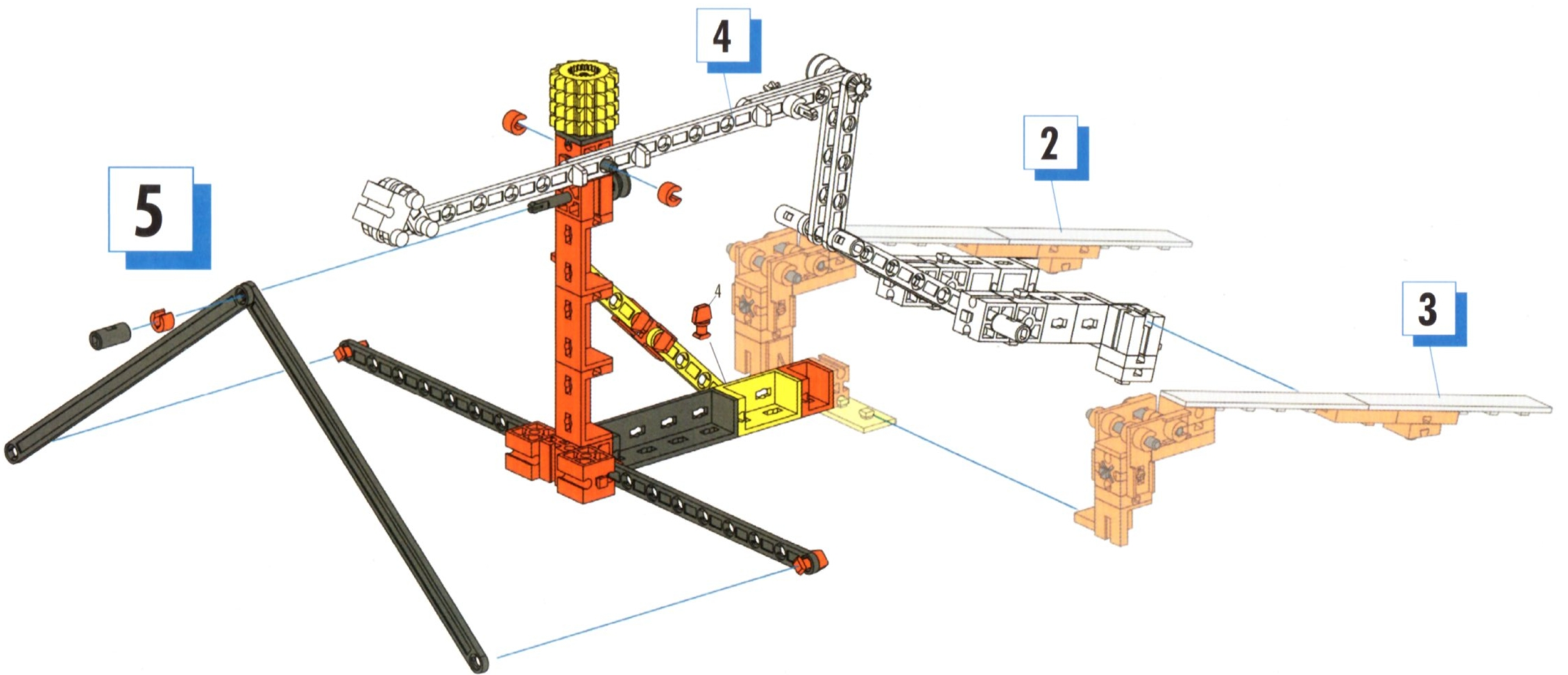



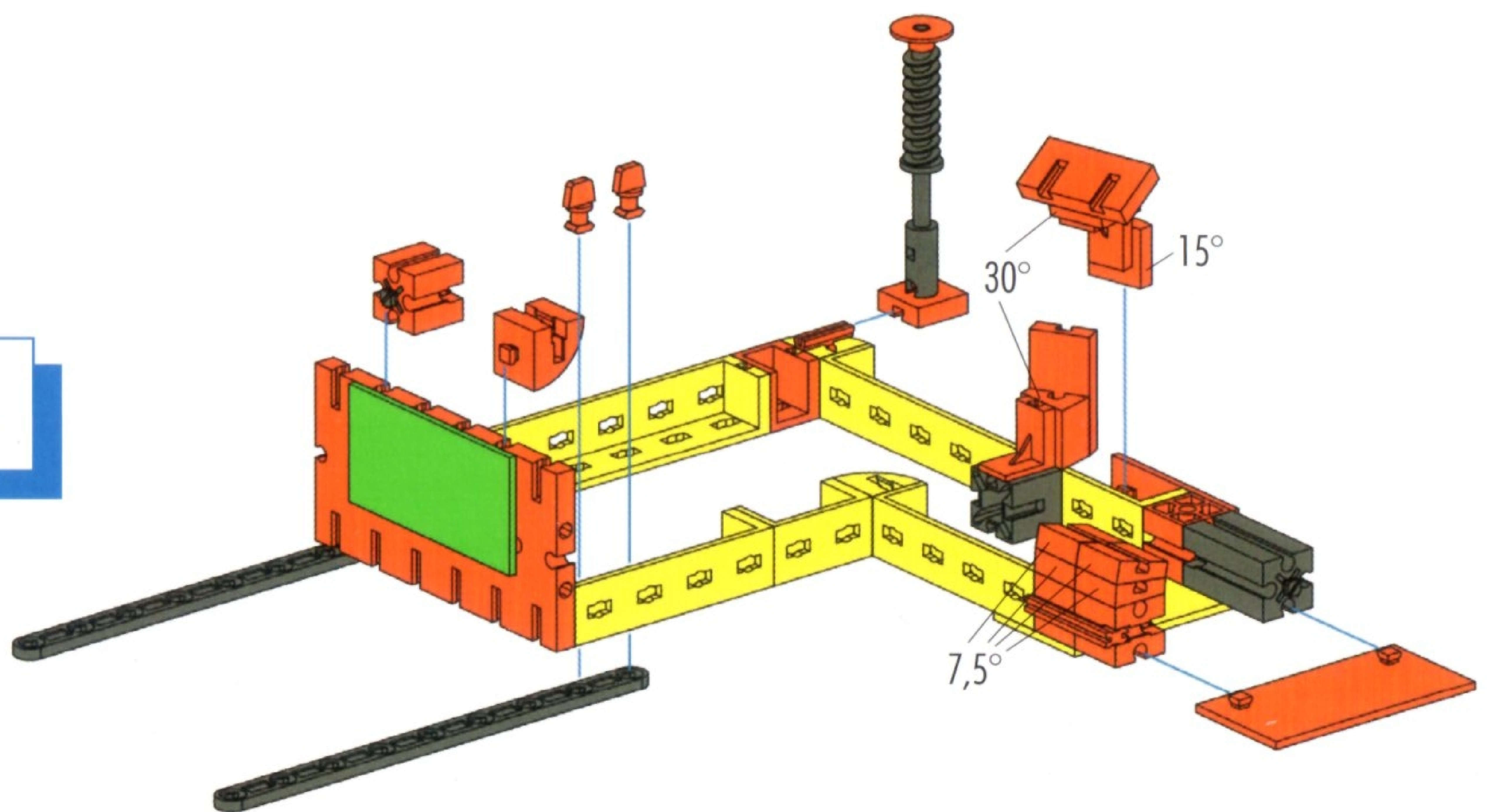

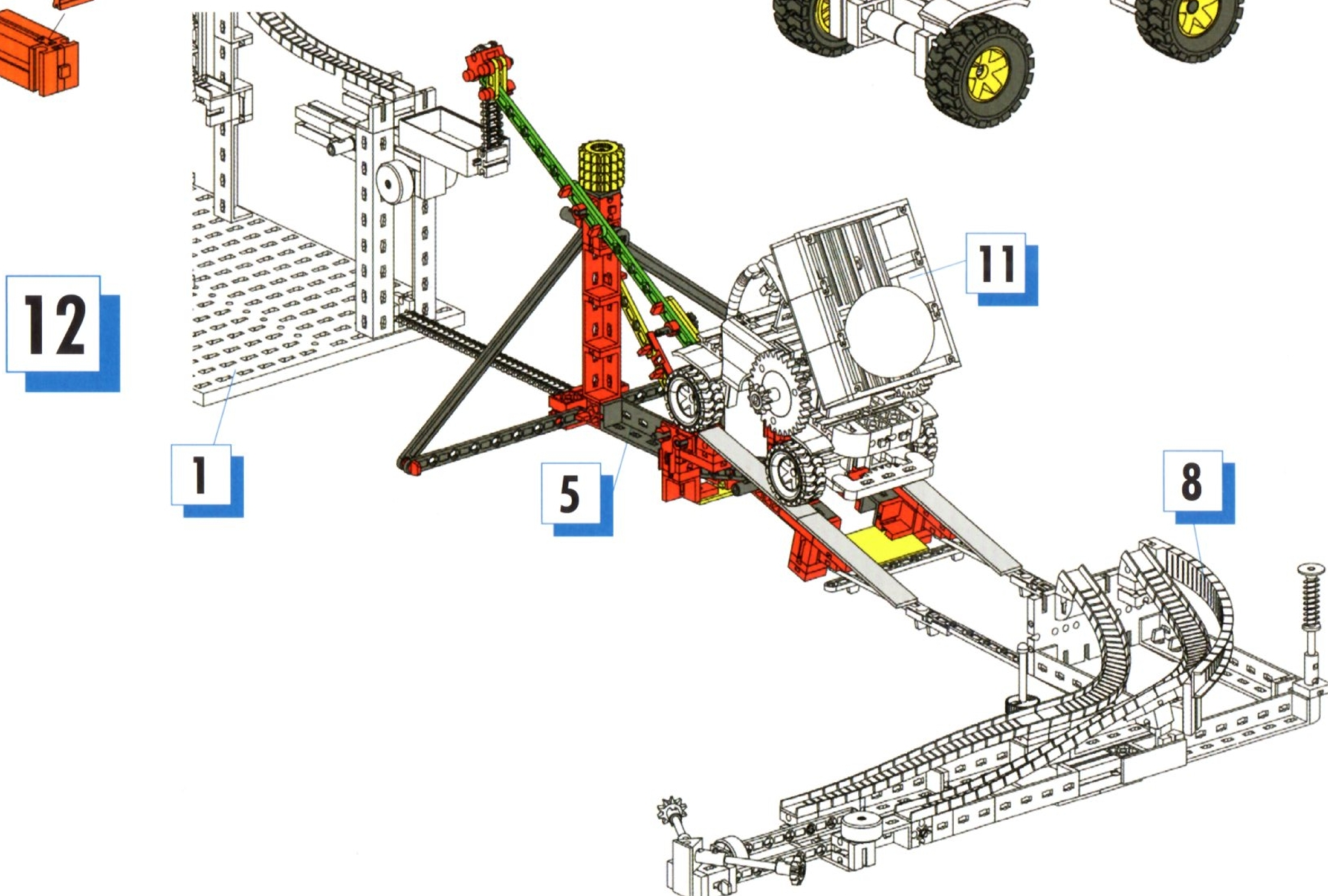
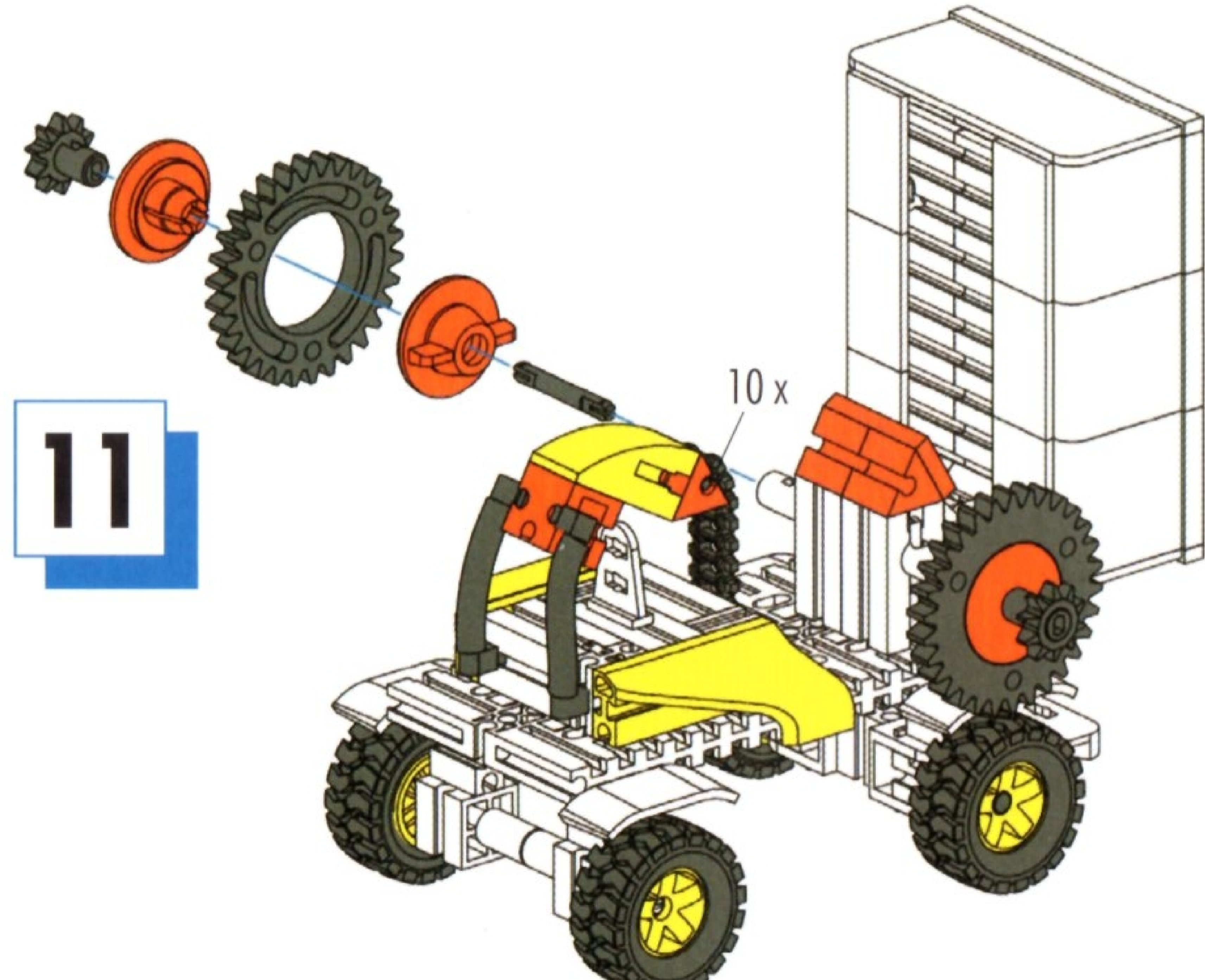
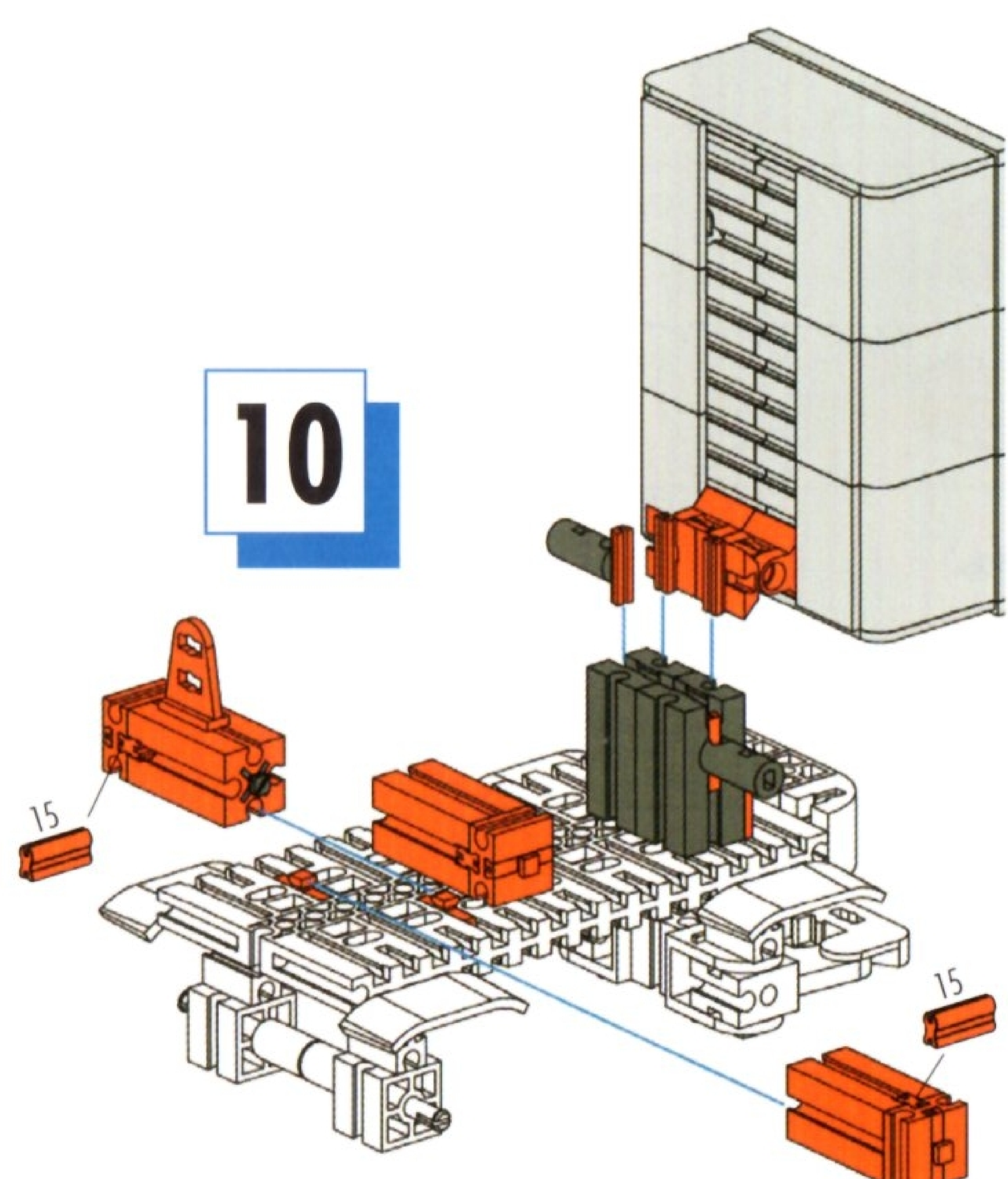
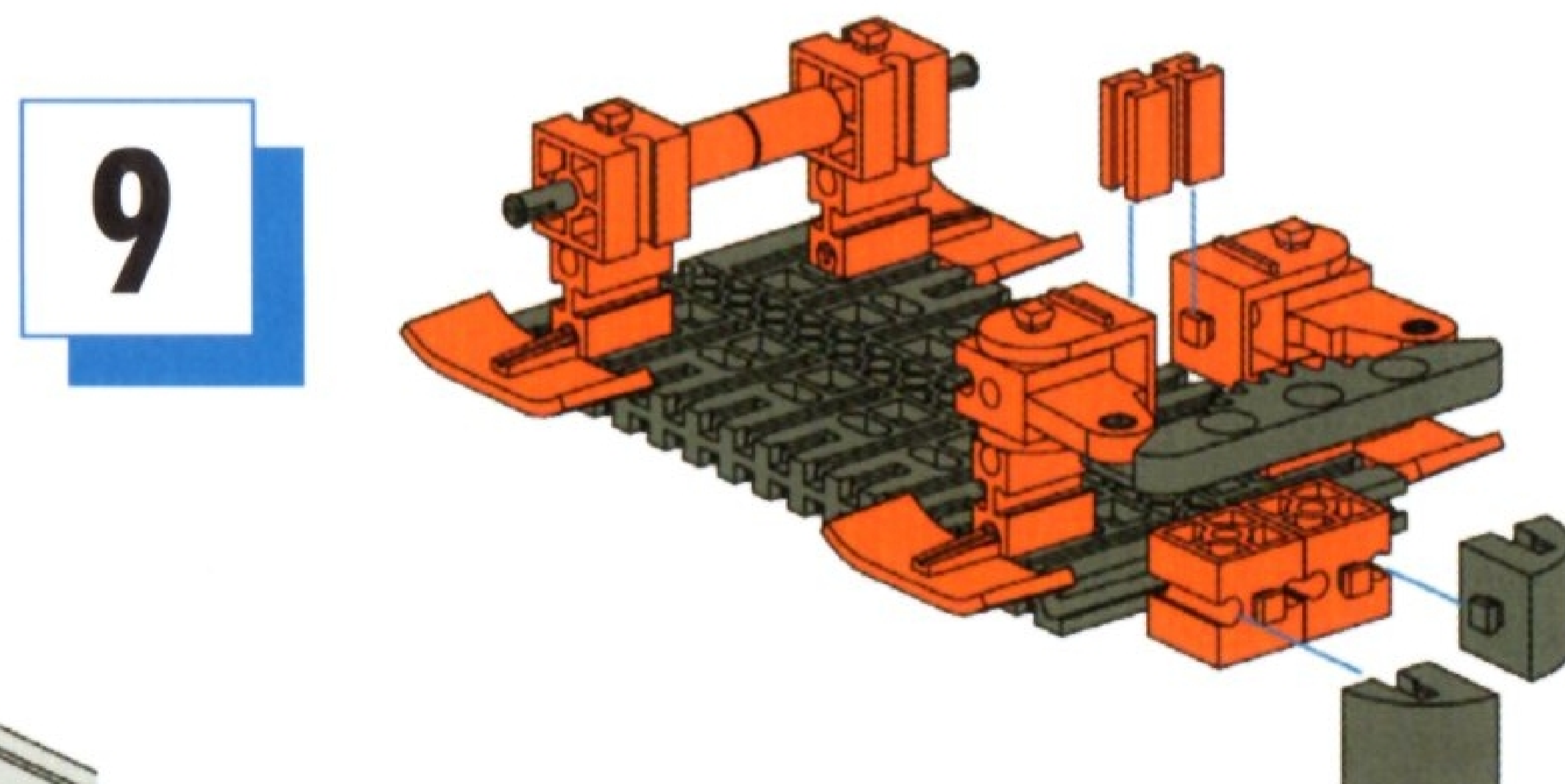
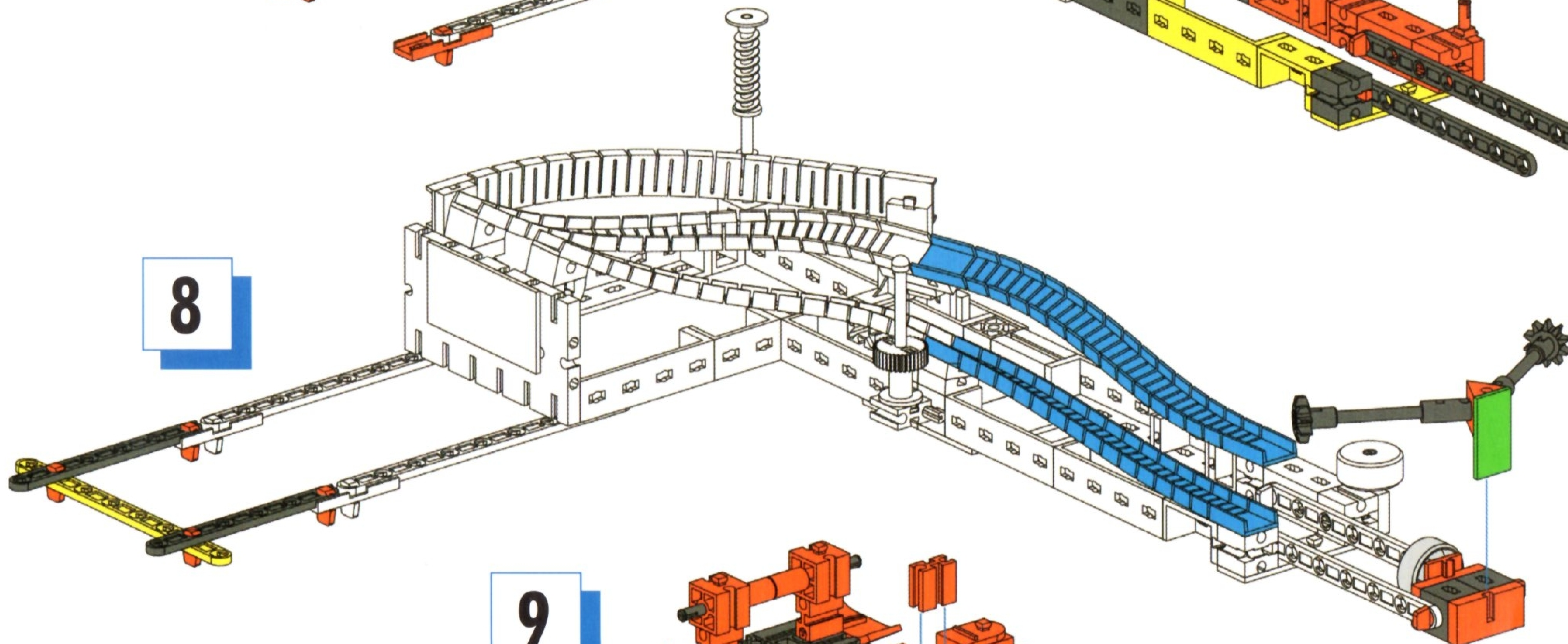
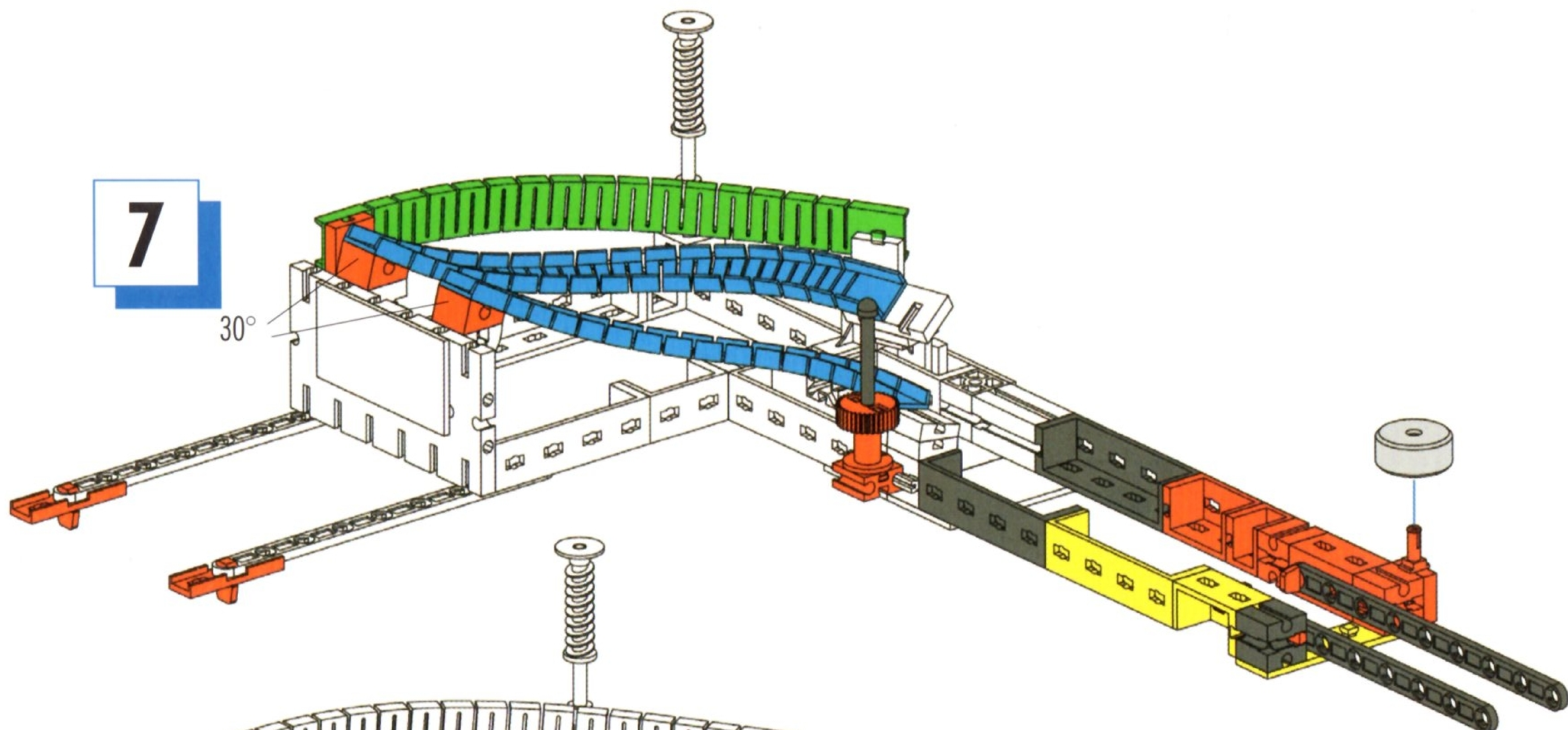





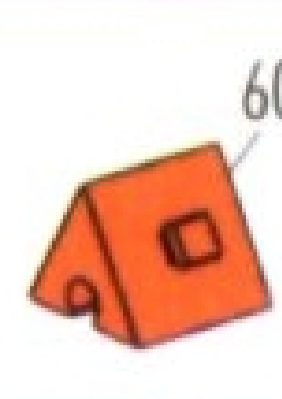

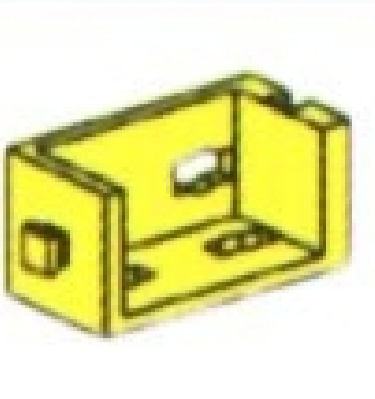
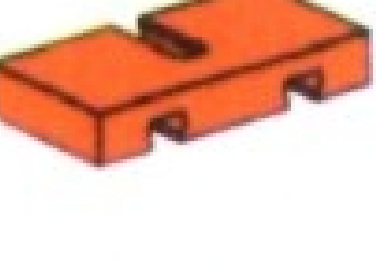
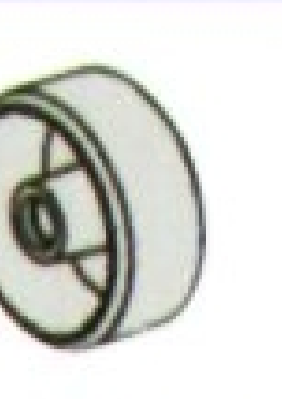



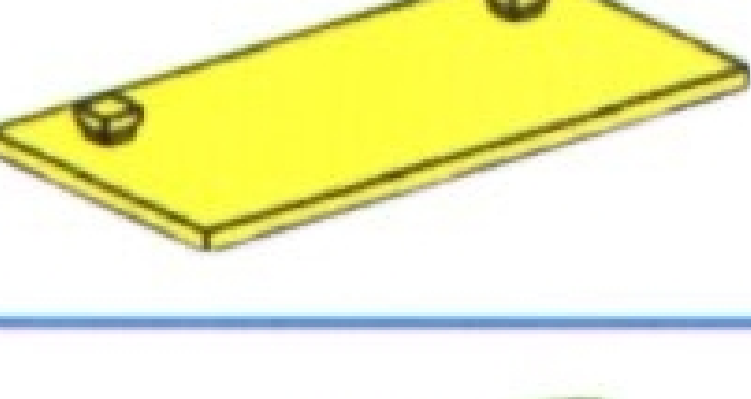
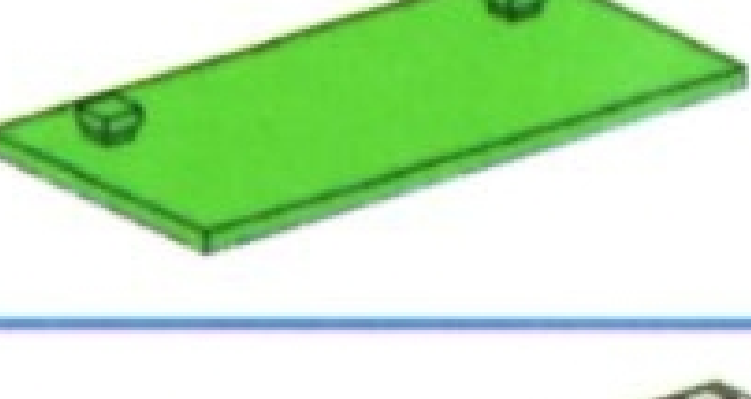
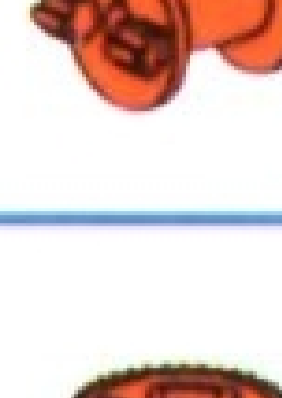



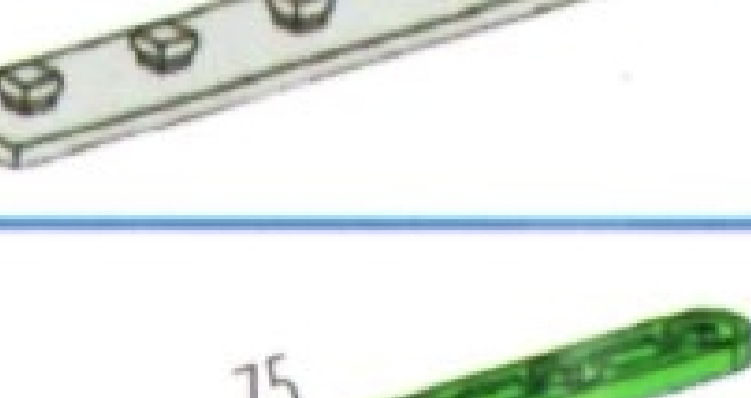
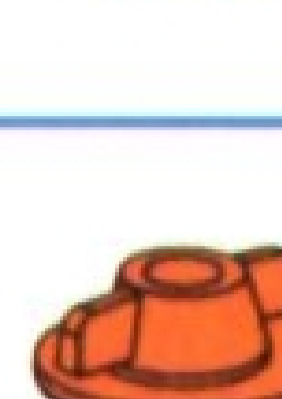
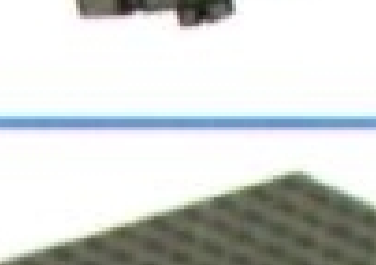
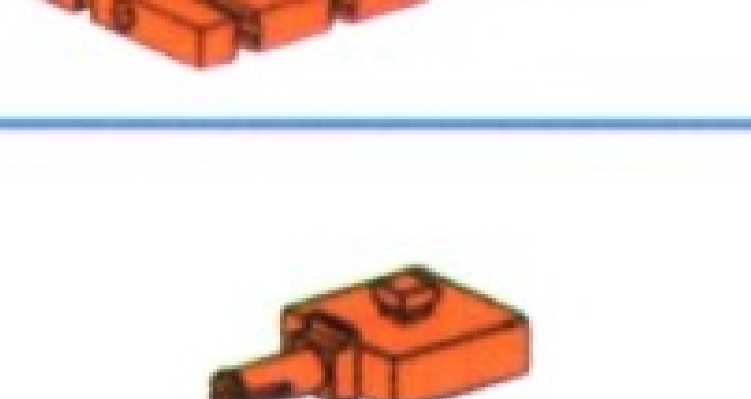
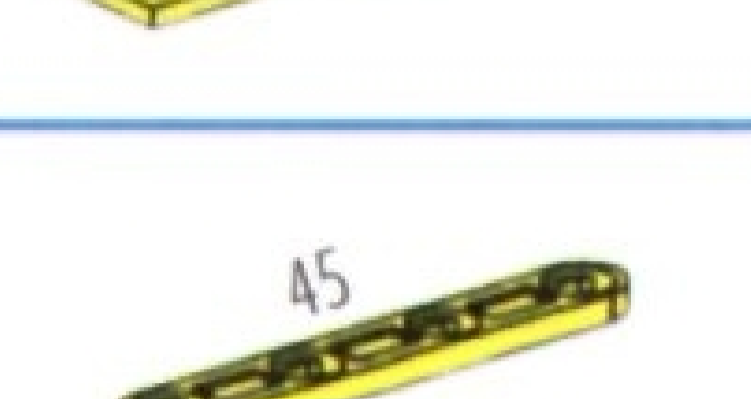
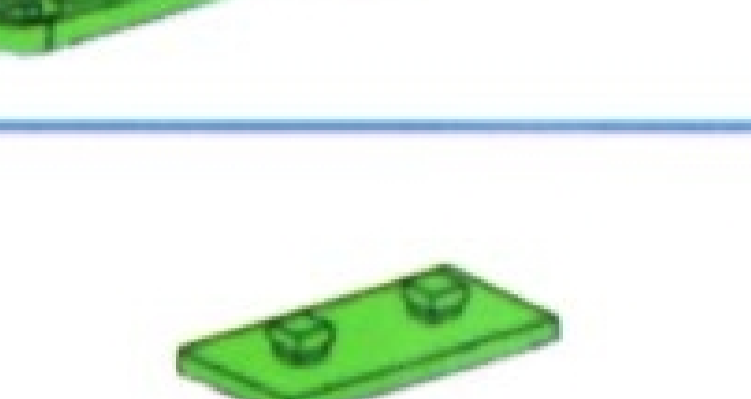



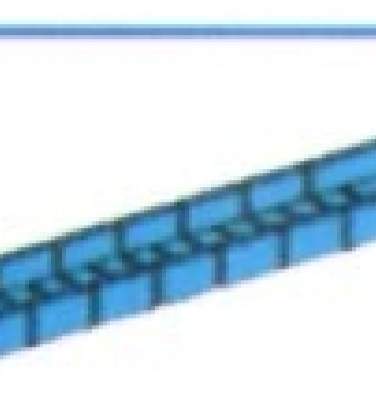



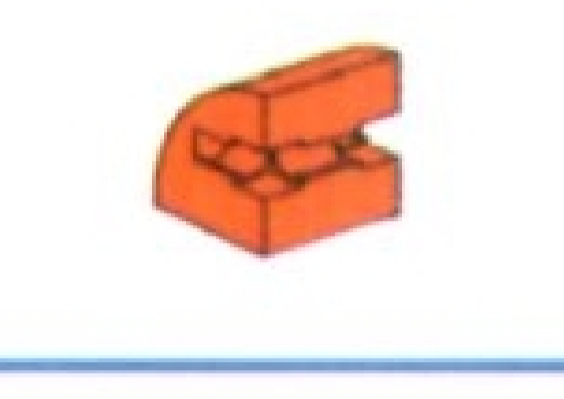

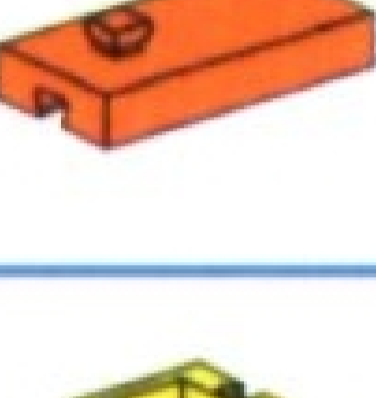
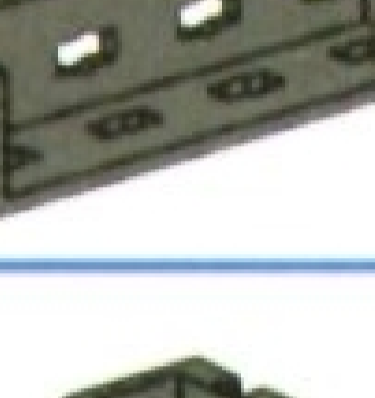
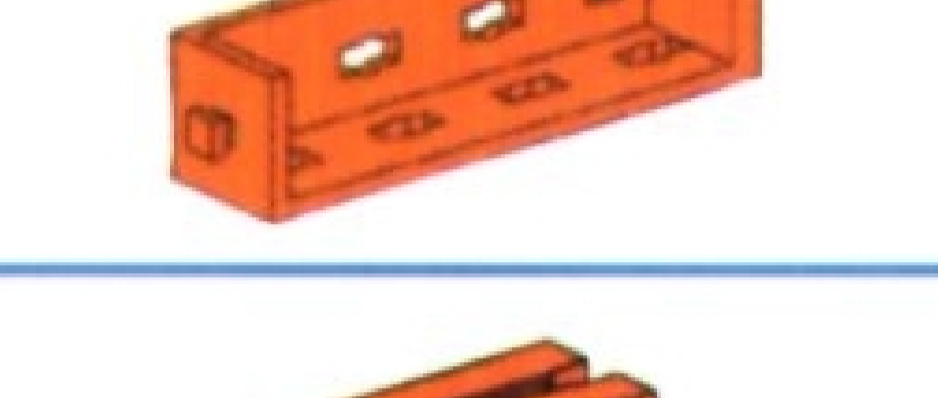
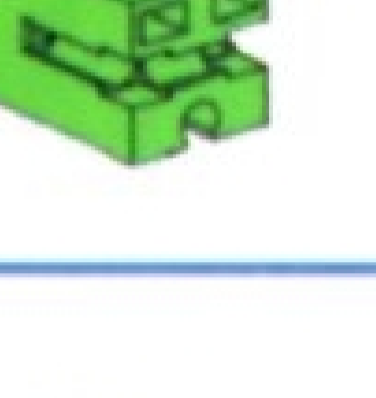
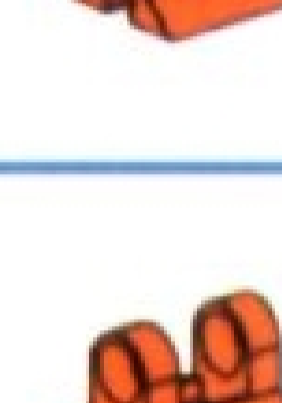

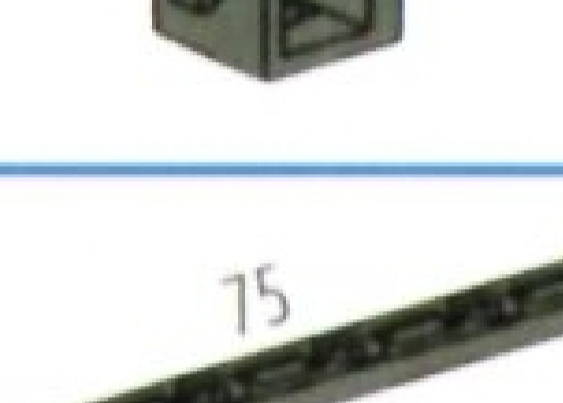
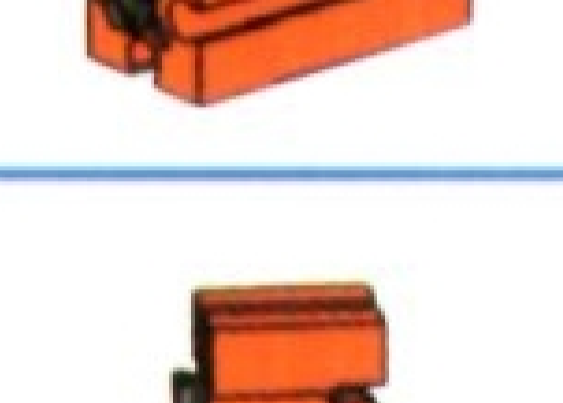

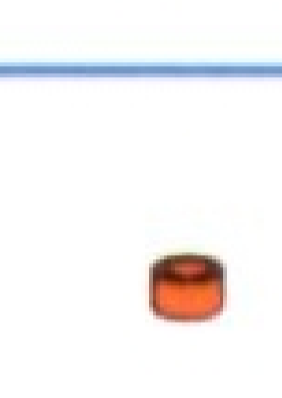

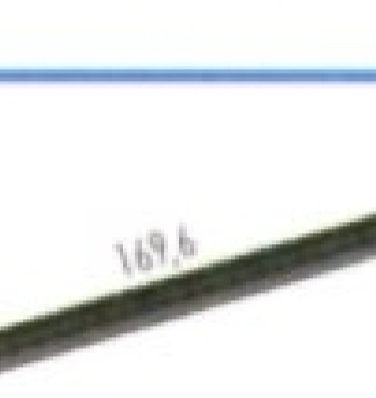
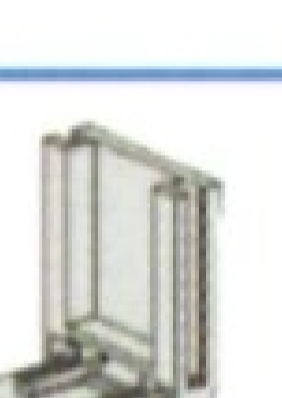
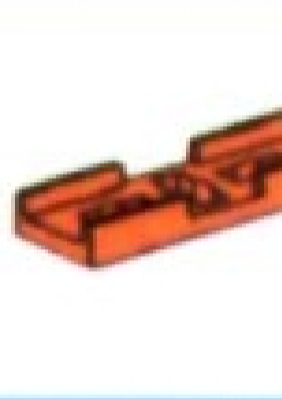

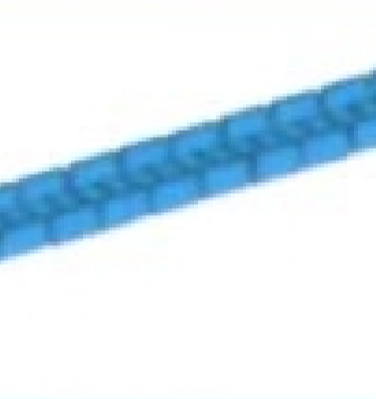
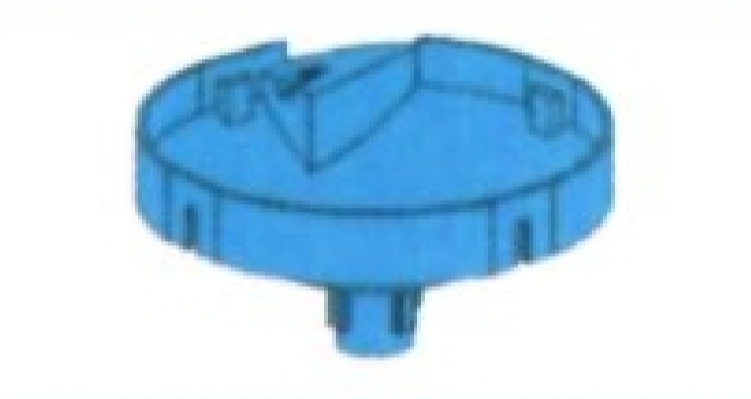

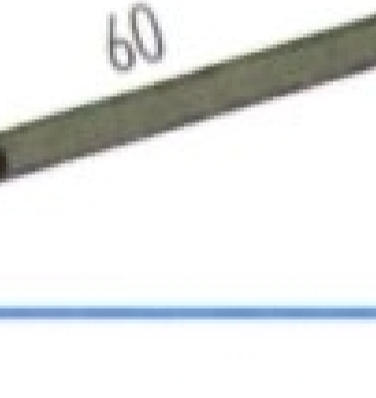

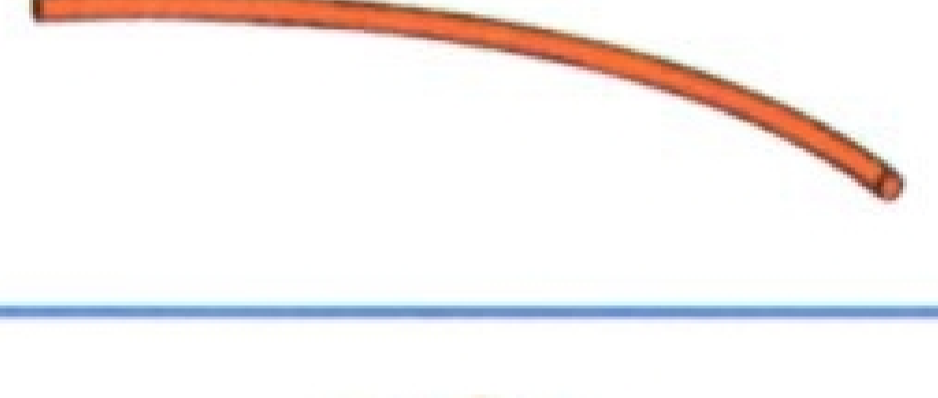

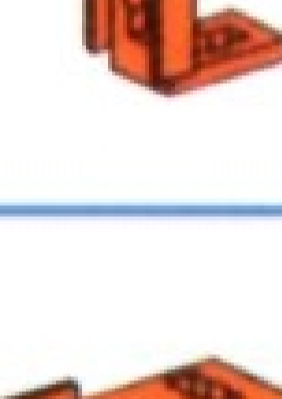
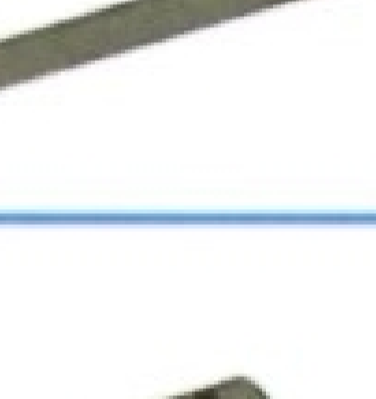

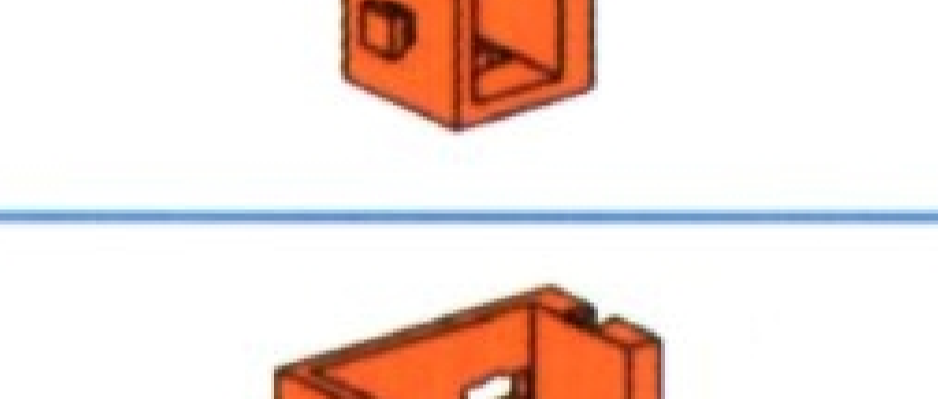







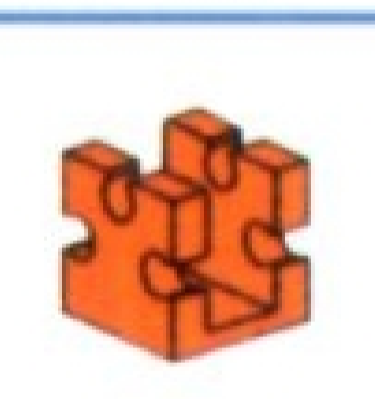

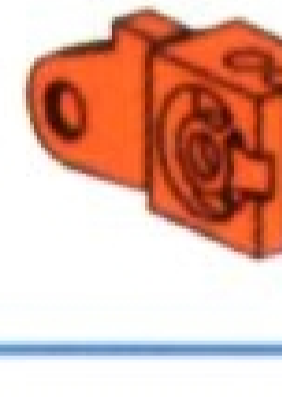
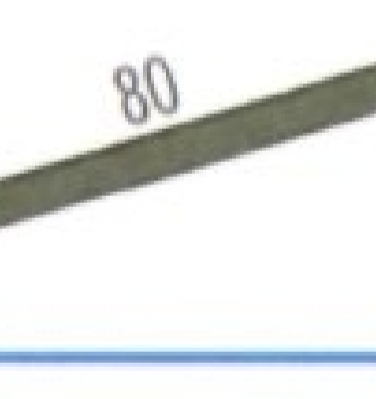

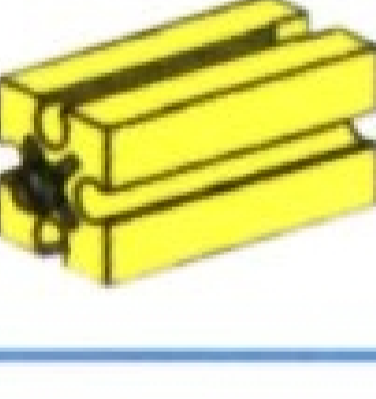
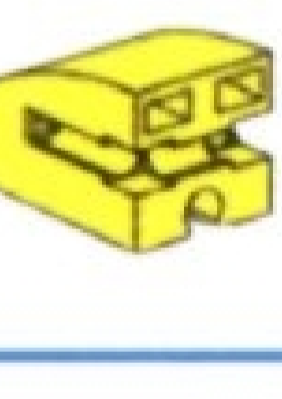
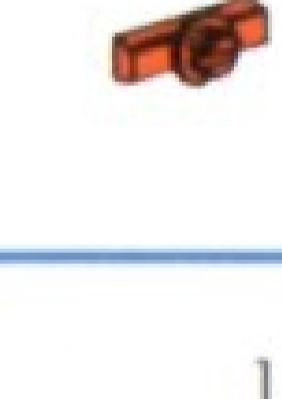

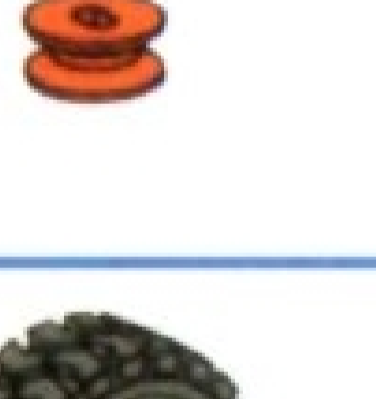

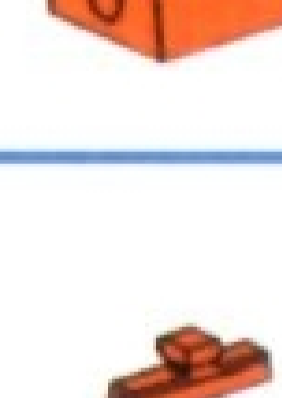
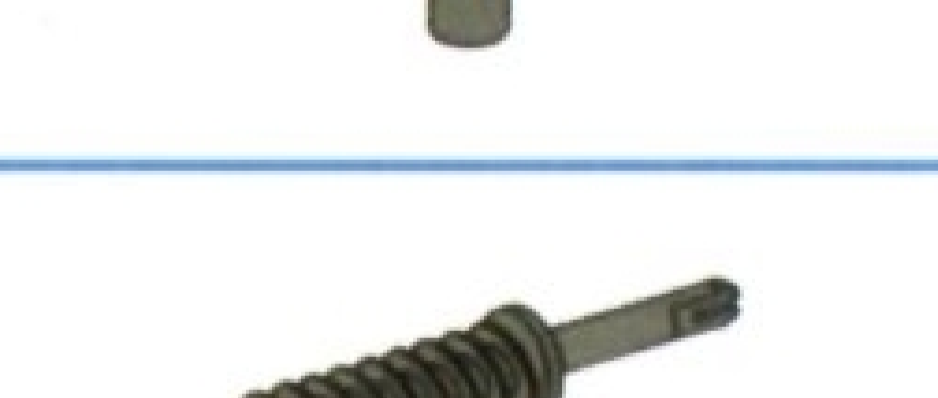
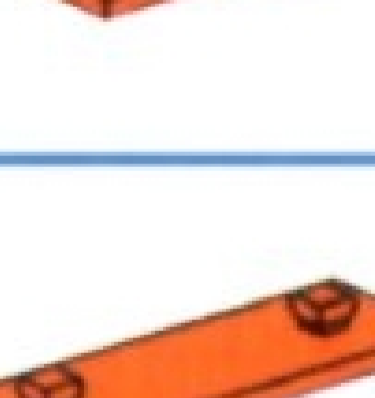

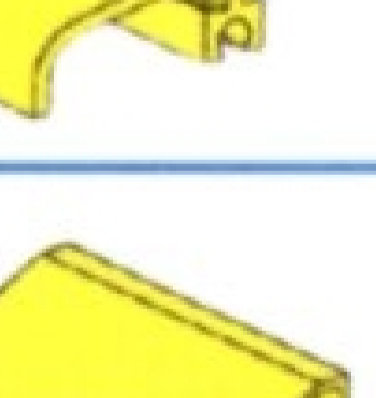

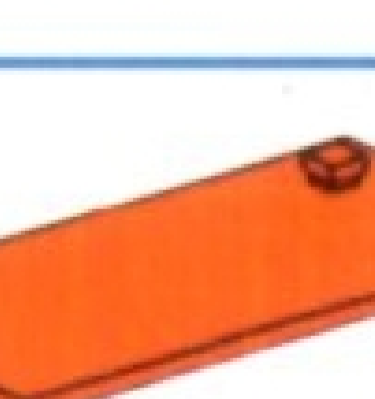
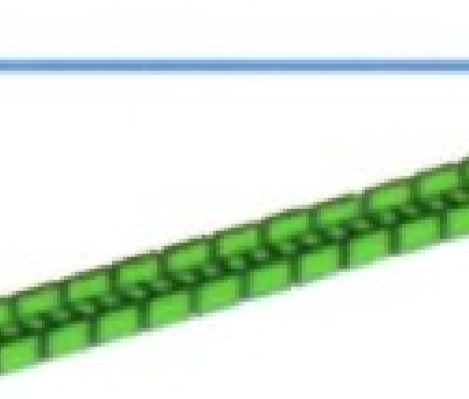

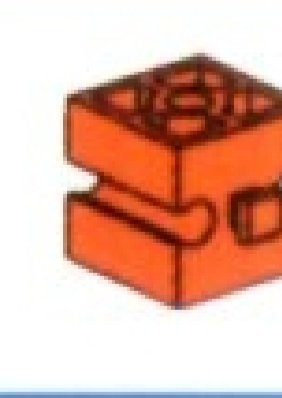



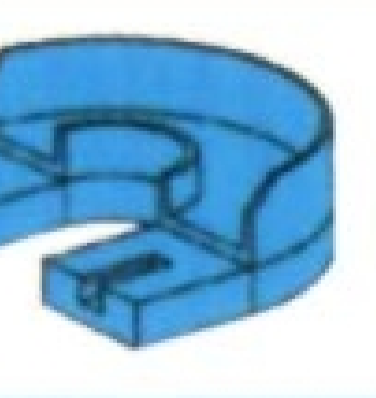
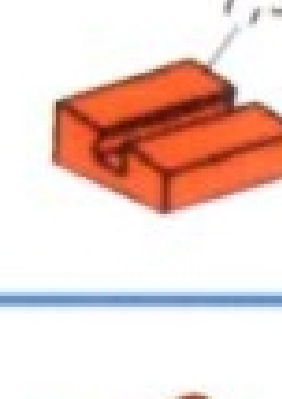

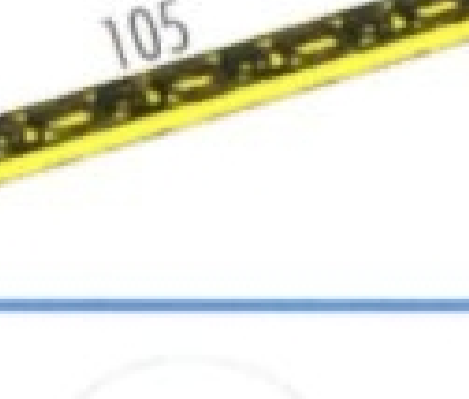

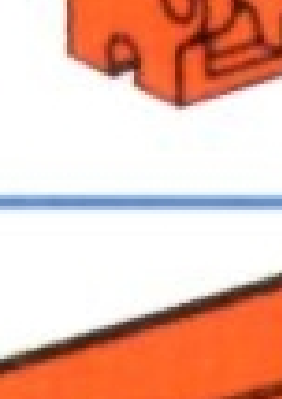
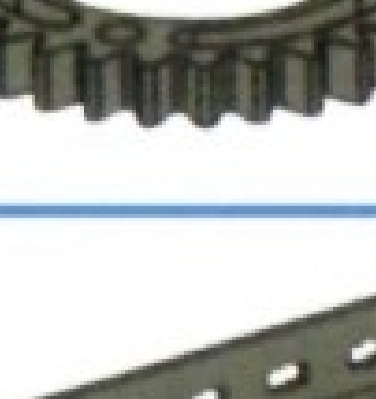
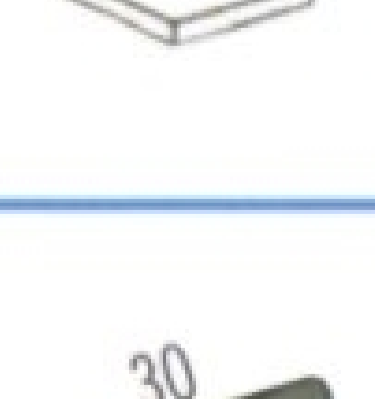
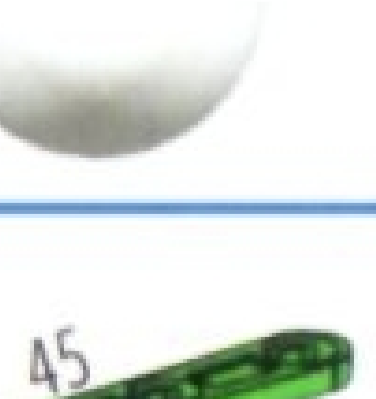

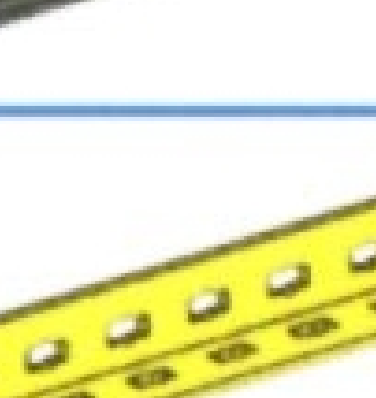

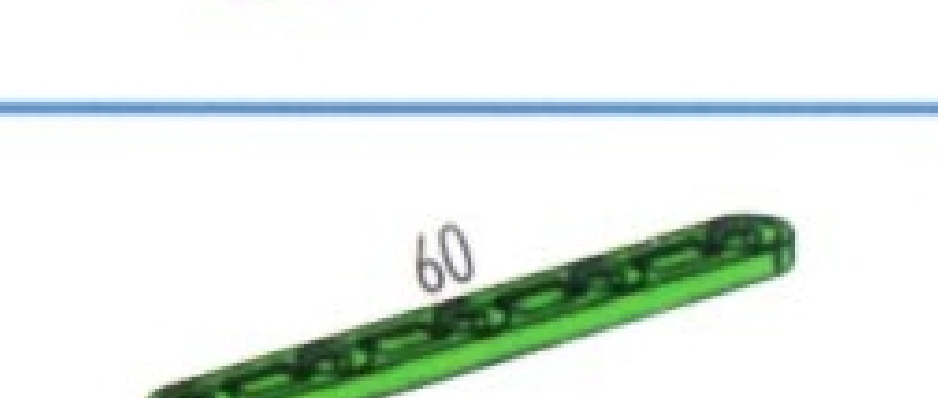
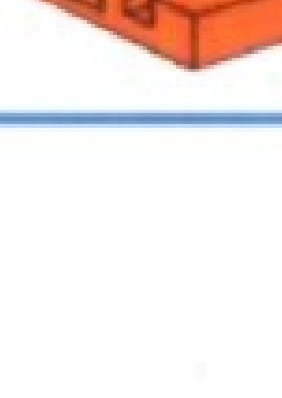
6

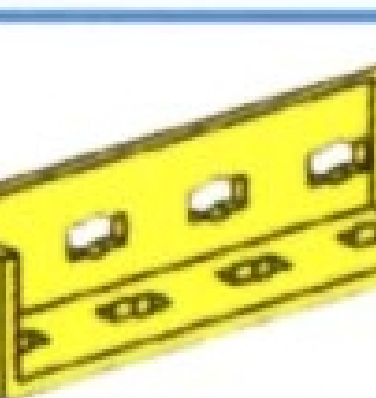

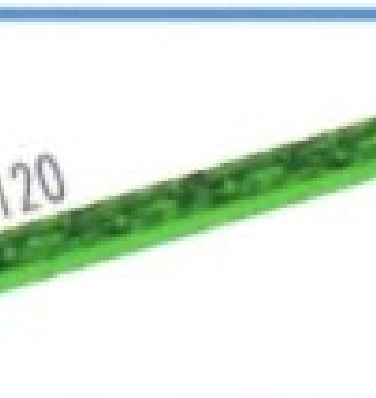

Einzelteilübersicht

Spare parts list

	31 010 5 x		32 870 1 x		36 299 5 x		38 428 6 x		146 535 4 x
	31 011 4 x		32 879 14 x		36 323 56 x		38 432 2 x		152 249 1 x
	31 016 1 x		32 881 13 x		36 334 1 x		38 472 1 x		156 106 4 x
	31 020 1 x		32 882 2 x		36 576 1 x		38 474 2 x		156 502 2 x
	31 058 2 x		32 985 3 x		36 586 4 x		38 541 4 x		156 504 1 x
	31 060 3 x		35 031 2 x		36 819 1 x		38 544 2 x		161 691 1 x
	31 061 6 x		35 039 1 x		36 920 13 x		38 546 6 x		163 201 2 x
	31 124 4 x		35 049 12 x		36 921 8 x		78 728 1 x		163 202 1 x
	31 426 5 x		35 053 1 x		36 922 5 x		116 251 3 x		163 203 4 x
	31 436 5 x		35 061 2 x		36 923 4 x		116 252 10 x		163 433 2 x
	31 597 9 x		35 063 3 x		36 950 12 x		119 753 2 x		163 435 6 x
	31 667 1 x		35 064 2 x		36 952 3 x		121 641 10 x		165 793 1 x
	31 668 5 x		35 065 3 x		36 973 1 x		122 950 1 x		172 539 4 x
	31 670 2 x		35 066 2 x		37 237 18 x		127 471 5 x		172 540 2 x
	31 671 6 x		35 073 10 x		37 238 1 x		127 472 7 x		172 541 2 x
	31 674 4 x		35 088 1 x		37 468 17 x		128 659 62 x		172 542 2 x
	31 690 10 x		35 129 1 x		37 636 5 x		130 593 2 x		172 543 2 x
	31 843 2 x		35 405 1 x		37 679 23 x		136 528 5 x		172 544 1 x
	31 848 8 x		35 797 2 x		38 240 23 x		136 775 1 x		172 545 4 x
	31 981 5 x		35 945 4 x		38 241 3 x		142 251 4 x		172 546 1 x
	31 982 22 x		35 977 1 x		38 242 1 x		142 252 4 x		172 547 1 x
	31 983 5 x		35 981 1 x		38 249 1 x		143 234 1 x		172 548 2 x
	32 064 22 x		35 998 2 x		38 253 4 x		144 262 5 x		173 572 2 x
	32 071 9 x		36 227 5 x		38 258 3 x		145 897 1 x		173 573 2 x
	32 085 3 x		36 264 2 x		38 263 1 x		146 375 1 x		173 574 2 x
	32 263 1 x		36 293 7 x		38 413 3 x		146 531 2 x		174 118 1 x
	32 330 3 x		36 294 3 x		38 414 2 x		146 532 2 x		
	32 850 2 x		36 297 6 x		38 423 5 x		146 533 8 x		