

FAN CLUB MODELL

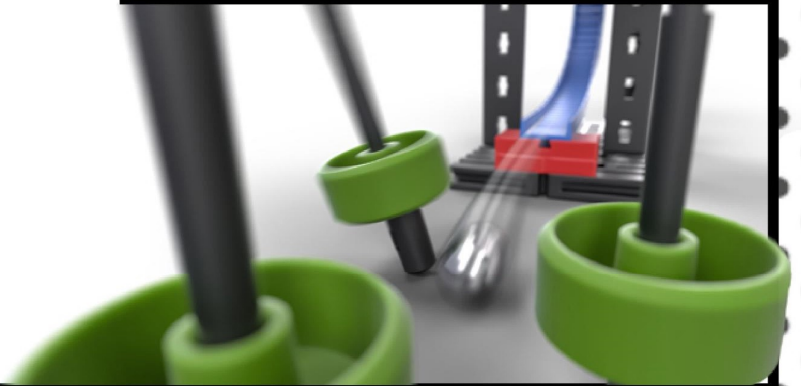
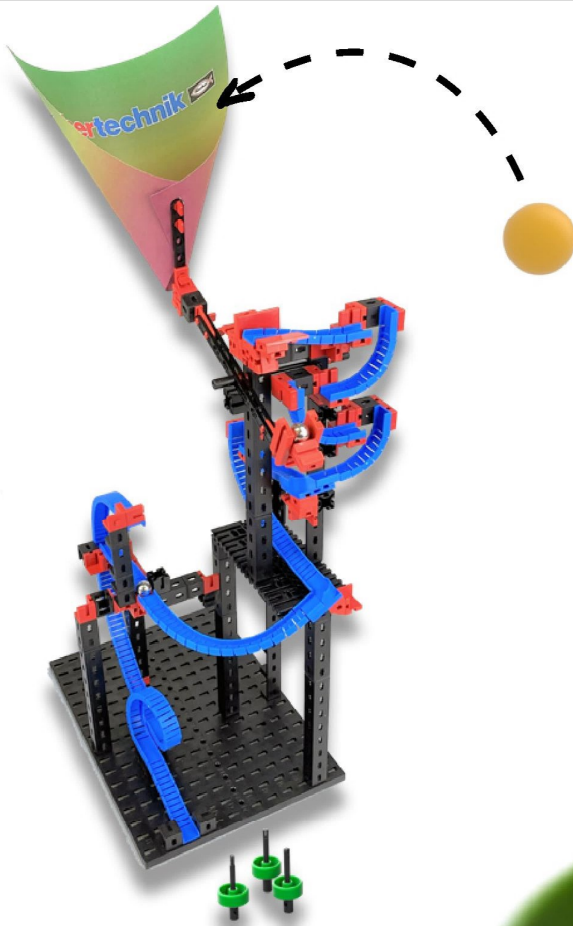

NR.62
ZUM SAMMELN

In der Neuheitenvorstellung habt ihr bereits unsere neuen Spiele kennengelernt. Zwei davon benötigt ihr, um das Fan Club Modell „Ping Pong Bowling 2.0“ nachzubauen.

Teile zusammensuchen und los geht's! Mit der Kombination aus den Neuheiten **Ping Pong Bowling** und **Labyrinth** zeigen wir euch in der Bauanleitung, wie ihr eine längere und mit Spezialeffekten ausgestattete Ping-Pong-Bowlingbahn erschaffen könnt. Wir haben die Strecke erweitert und eine zusätzliche Stoppstelle eingebaut. Die erste Kugel stößt eine weitere, auf der Bahn liegende, an und bleibt daraufhin liegen, während die zweite Kugel weiter flitzt. Am Ende wartet auf sie ein Looping, bevor die Kegel umgestoßen werden. Wie viele erwischt ihr auf einen Streich?

Ping Pong Bowling

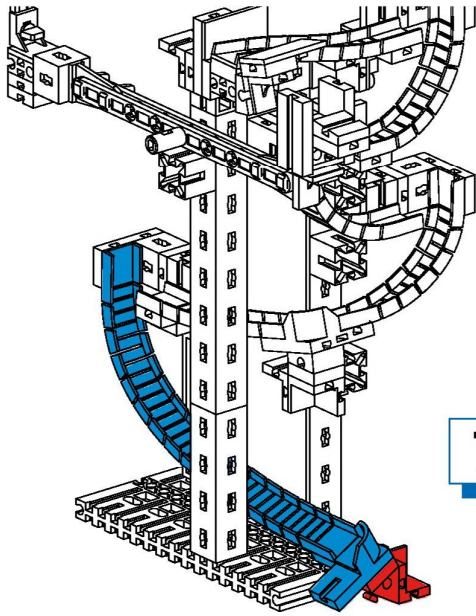

1

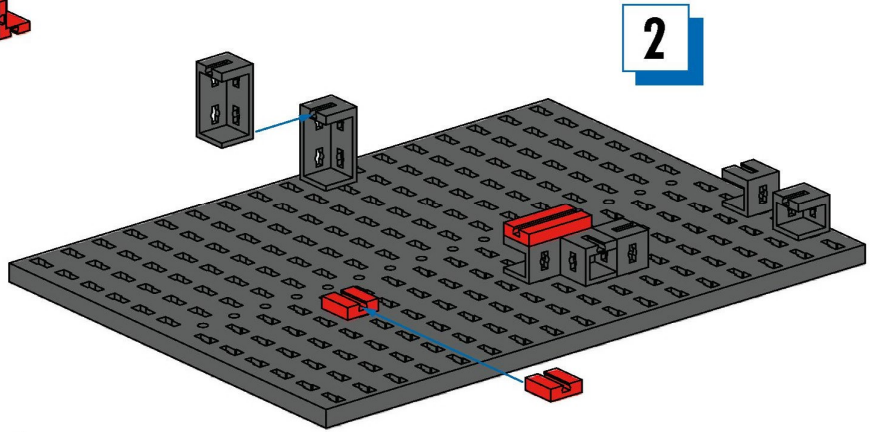

2

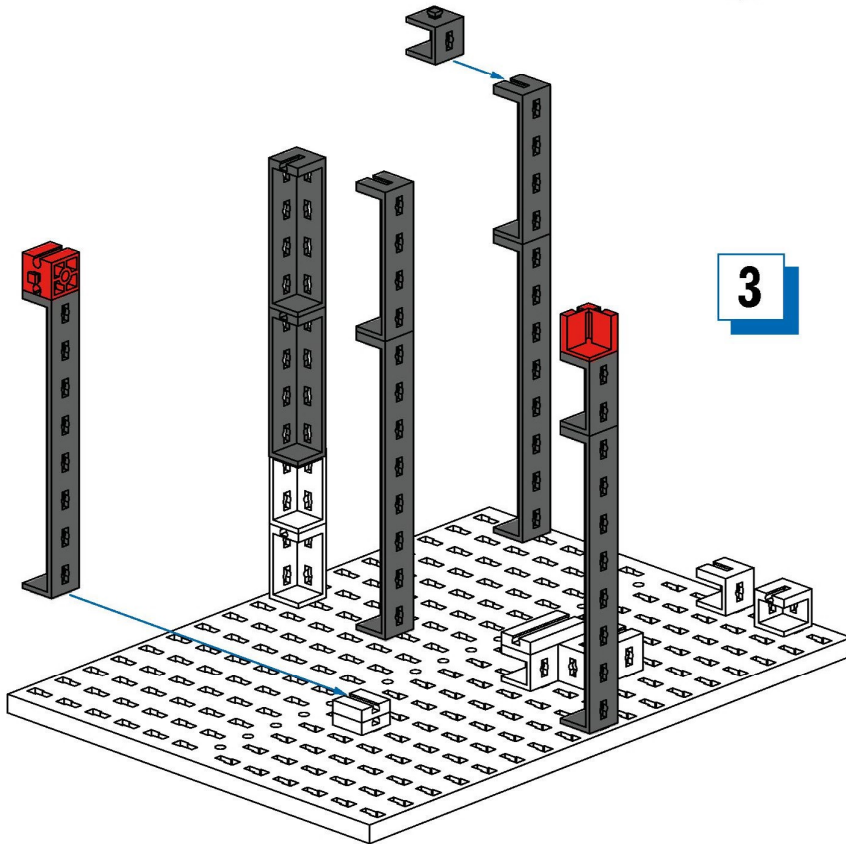

3

4

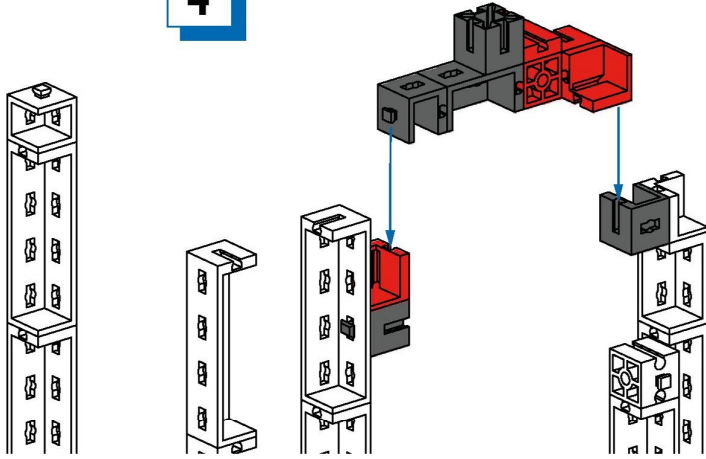



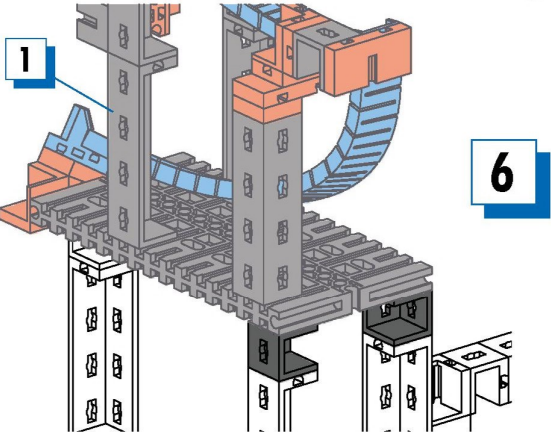
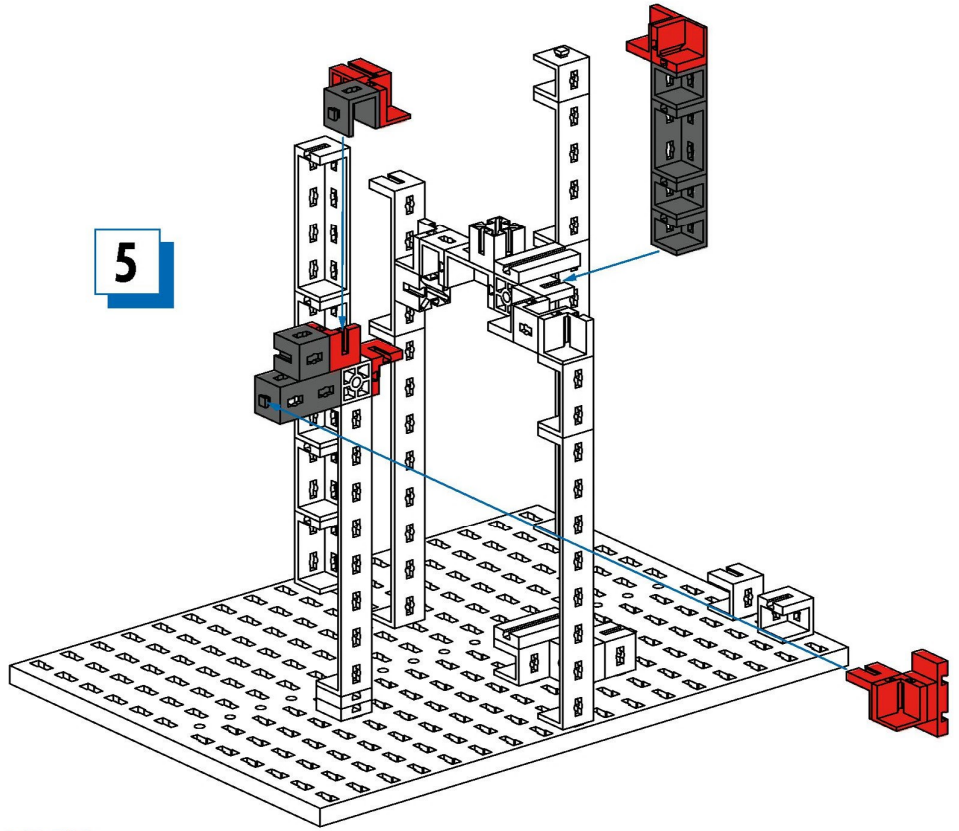



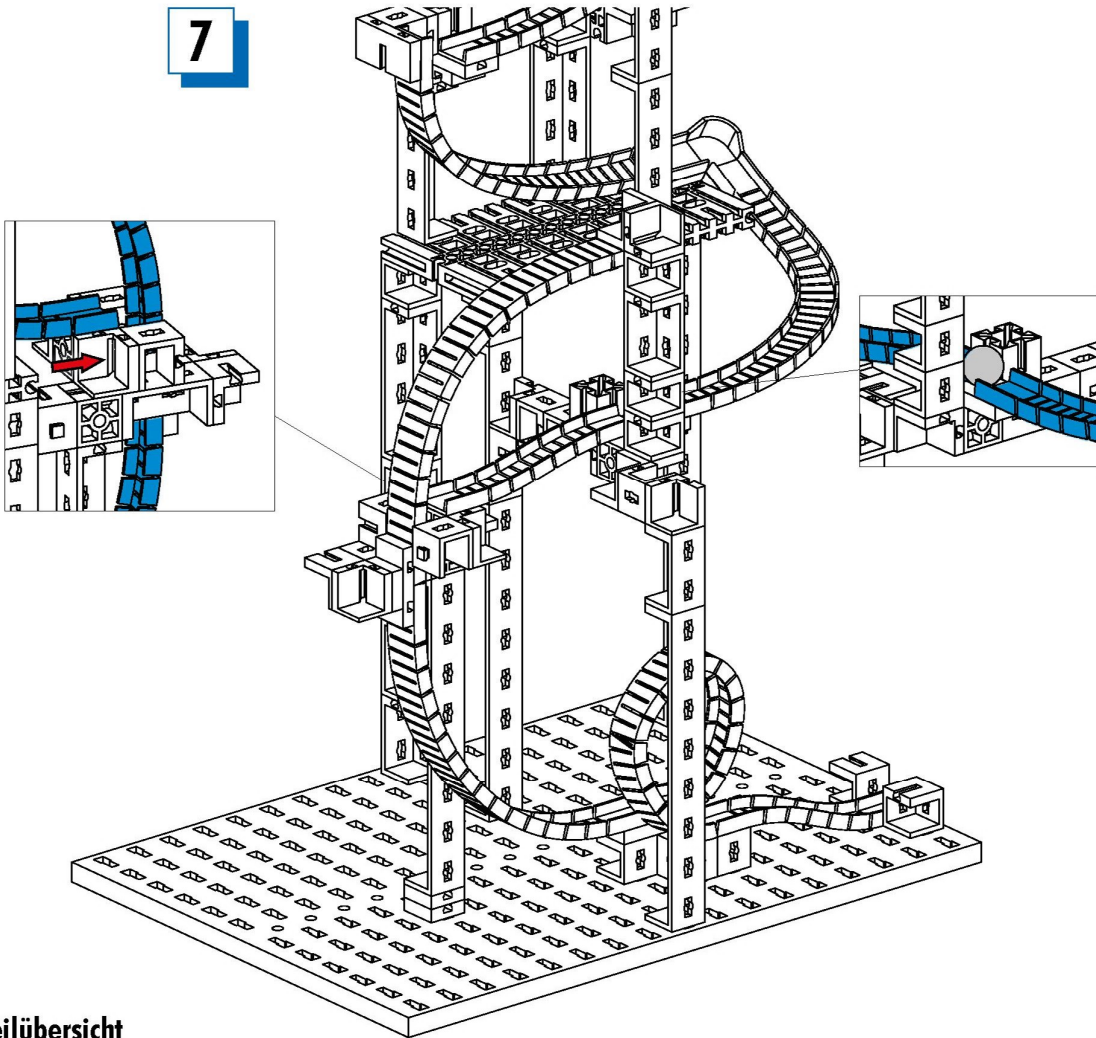







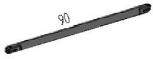























5

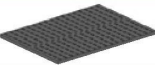

7



Einzelteilübersicht
Spare parts list

	31 010 1 x		35 064 3 x		36 922 12 x		38 423 2 x
	31 597 2 x		35 066 1 x		36 950 10 x		38 428 6 x
	31 674 1 x		35 073 5 x		36 952 1 x		38 546 2 x
	31 981 2 x		35 129 1 x		37 237 12 x		38 641 5 x
	31 982 3 x		36 293 6 x		37 238 5 x		144 262 2 x
	32 064 4 x		36 323 3 x		37 468 5 x		154 452 3 x
	32 071 2 x		36 324 4 x		37 679 1 x		154 485 1 x
	32 650 6 x		36 334 2 x		38 240 24 x		161 690 2 x
	32 985 1 x		36 920 6 x		38 241 2 x		161 691 7 x
	35 049 10 x		36 921 7 x		38 260 2 x		199 881 1 x