

Motor+
Getriebe

fischertechnik®

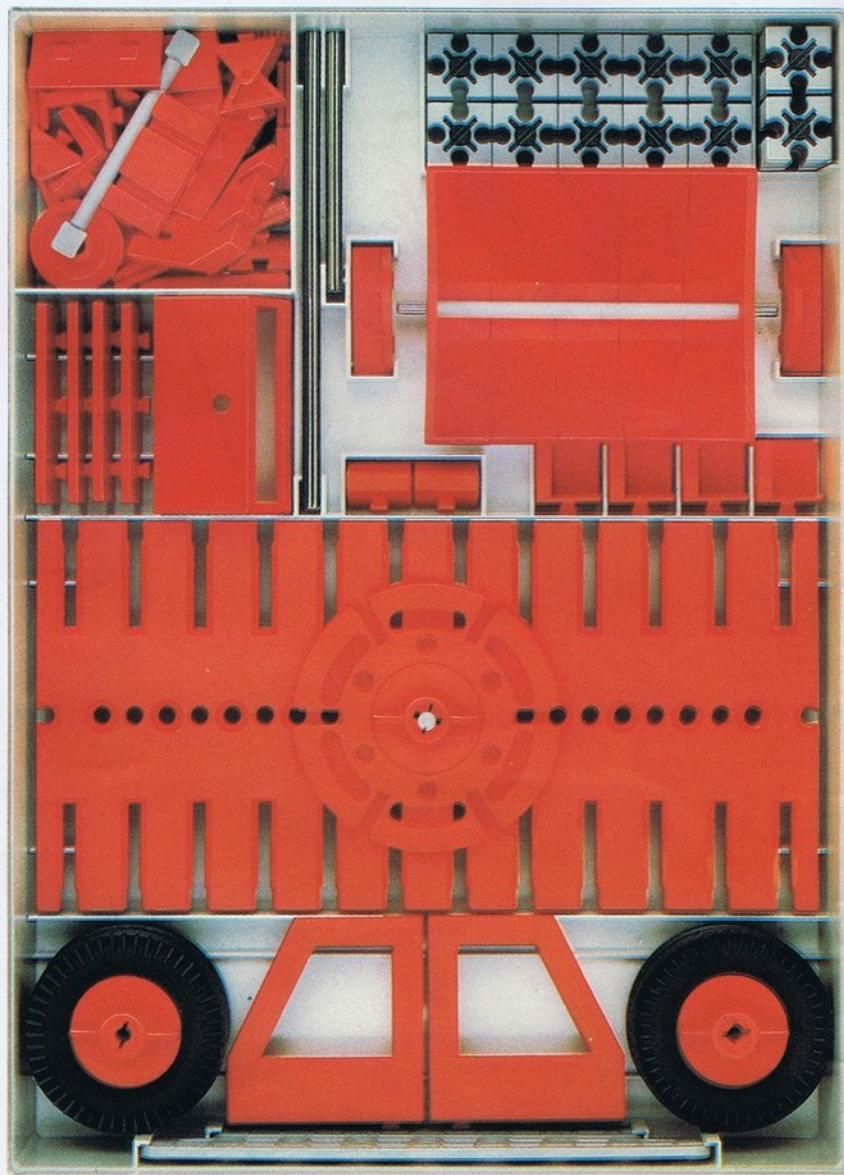

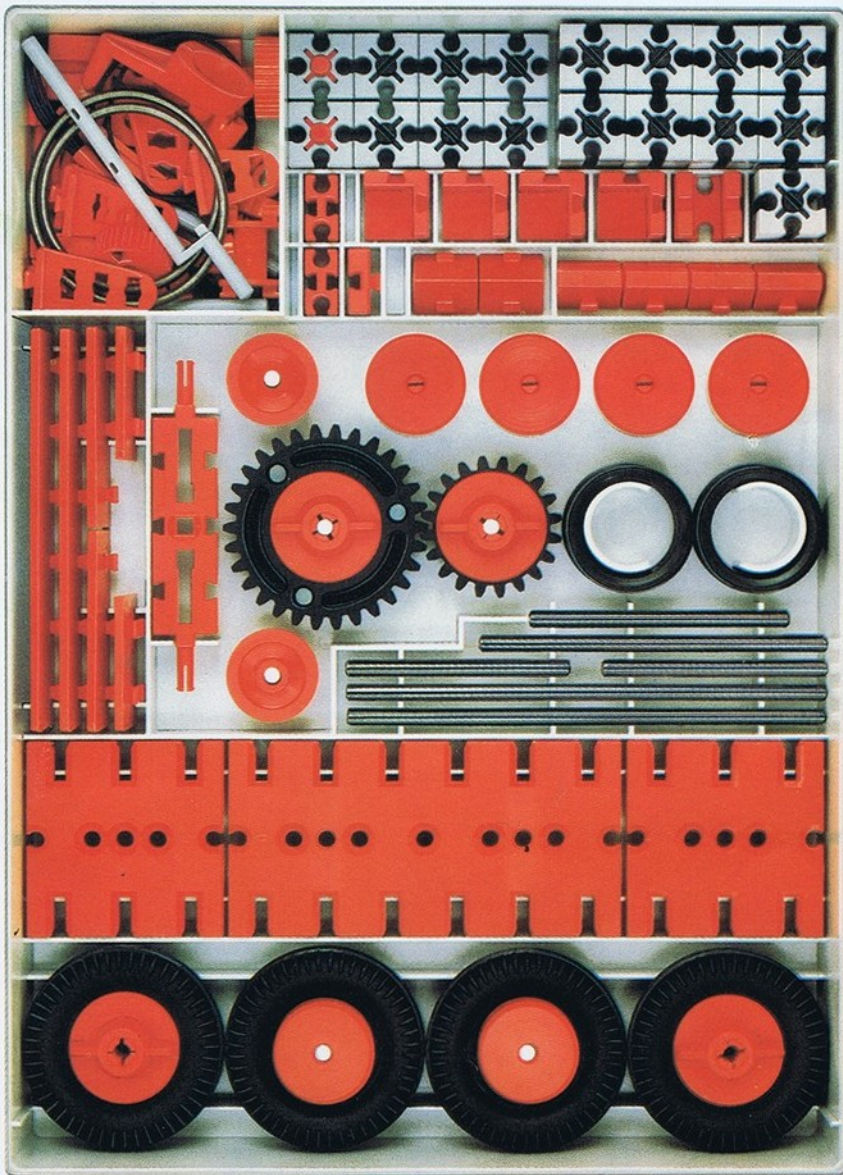

Start 100

Start 200



fischertechnik beginnt mit Start 100 (100 verschiedene Modelle) oder Start 200 (200 verschiedene Modelle).

Start 100 wird erweitert durch Start 100/1 (50/2) auf Start 200.

Start 200 wird erweitert durch Start 200/1 (50/3). Es ergeben sich viele neue interessante Baumöglichkeiten.



fischertechnik begins with either "Start 100" (100 different models) or "Start 200" (200 different models).

"Start 100" may be converted into "Start 200" by using "Start 100/1" (50/2).

"Start 200" may be converted using "Start 200/1" (50/3). Many new and interesting construction ideas result.



fischertechnik débute avec «Start 100» (100 modèles différents) ou «Start 200» (200 modèles différents).

«Start 100» peut se compléter en version «Start 200» moyennant «Start 100/1» (50/2).

«Start 200» peut se compléter moyennant «Start 200/1» (50/3). Il en résulte de nombreuses nouvelles possibilités de construction particulièrement intéressantes.



fischertechnik begint met „Start 100“ (100 verschillende modellen) of „Start 200“ (200 verschillende modellen).

„Start 100“ kan door „Start 100/1“ (50/2) uitgebreid worden.

„Start 200“ kan door „Start 200/1“ (50/3) uitgebreid worden. Daardoor ontstaan talloze nieuwe bouw mogelijkheden.

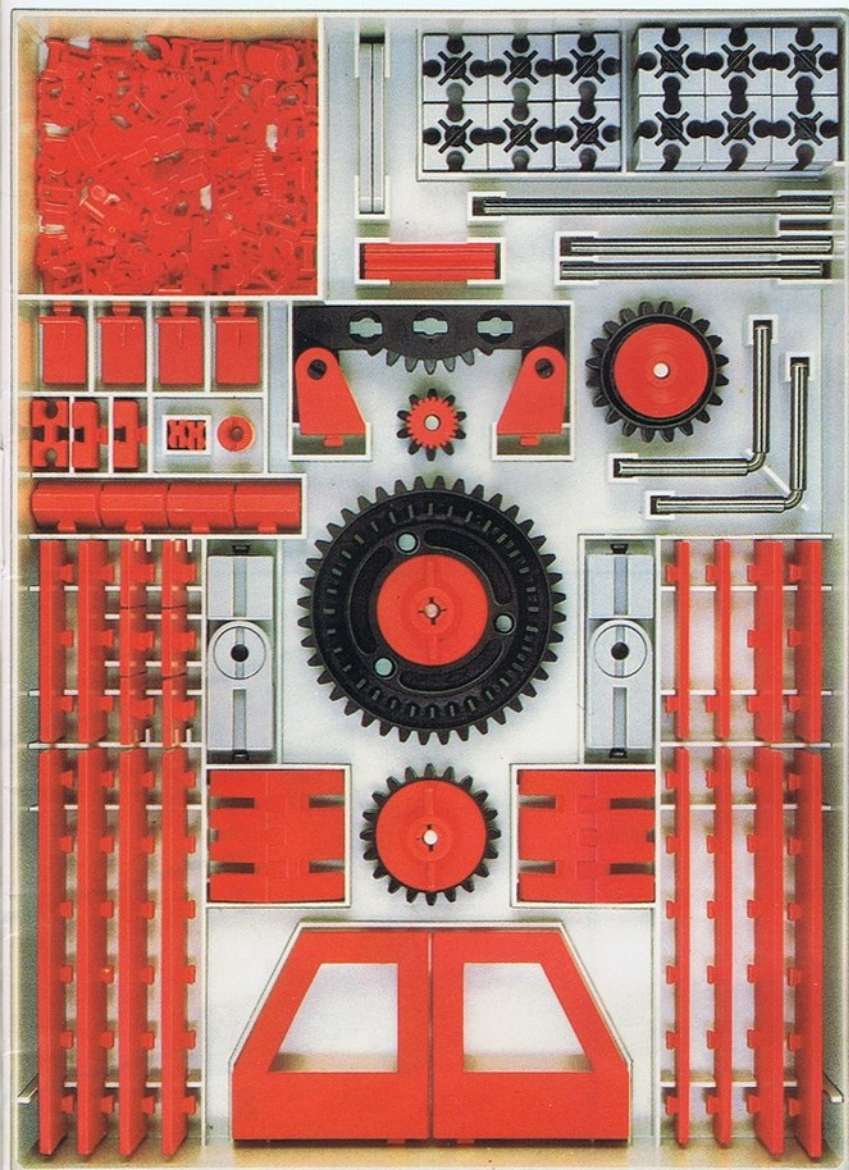

Start 100/1 (50/2)



fischertechnik comienza con «Start 100» (100 modelos diferentes) o con «Start 200» (200 modelos diferentes).

«Start 100» puede ser ampliado por «Start 100/1» (50/2) a «Start 200».

«Start 200» puede ser ampliado por «Start 200/1» (50/3). La caja ofrece muchas nuevas posibilidades de construcción muy interesantes.



Il gioco fischertechnik ha inizio con: «Start 100» (100 diversi modelli) oppure «Start 200» (200 diversi modelli).

Aggiungendo allo «Start 100» la cassetta di ampliamento «Start 100/1» (50/2) si compone lo «Start 200».

Lo «Start 200» può essere ulteriormente perfezionato con la cassetta «Start 200/1» (50/3) per avere molte altre possibilità di costruzione.

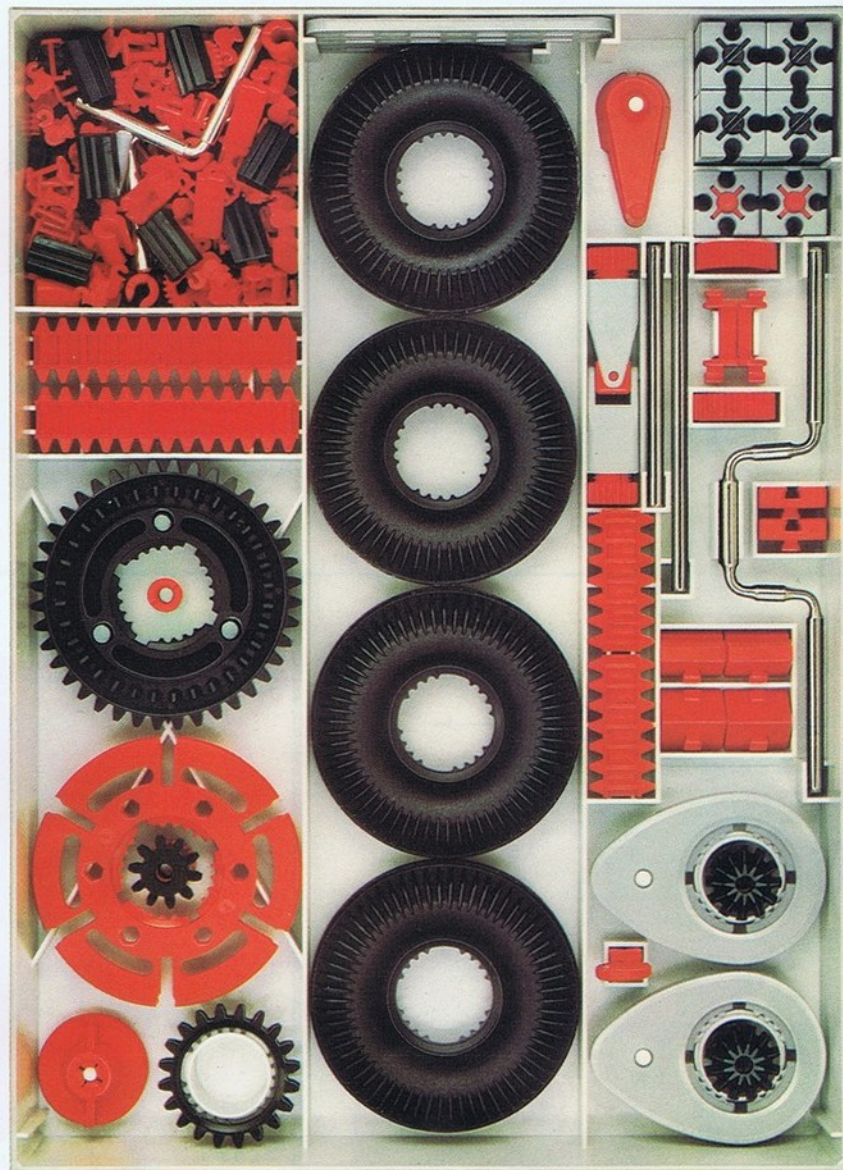

Start 200/1 (50/3)



fischertechnik börjar med »Start 100» (100 olika modeller) eller »Start 200» (200 olika modeller).

»Start 100» bygges ut med »Start 100/1» (50/2) till »Start 200».

»Start 200» bygges ut med »Start 200/1» (50/3). Det ger många nya intressanta byggmöjligheter.

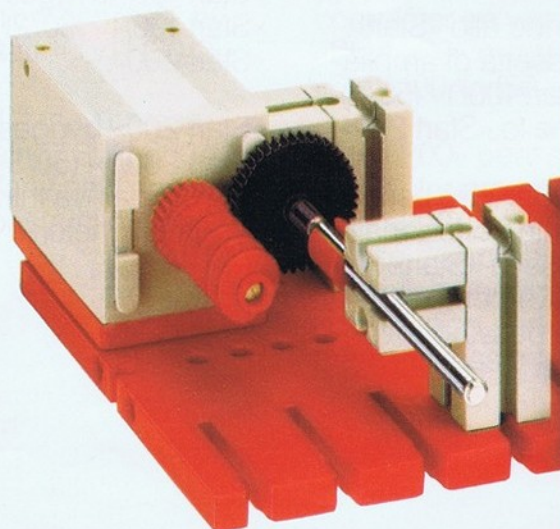
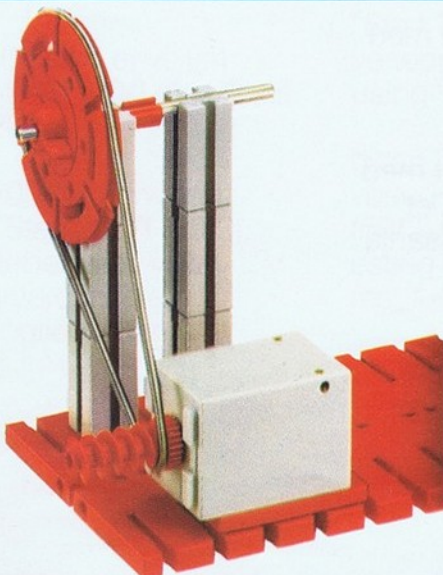
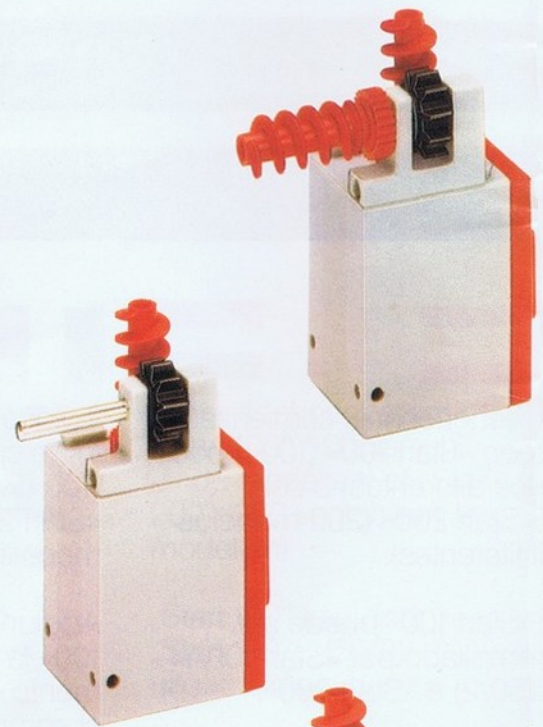
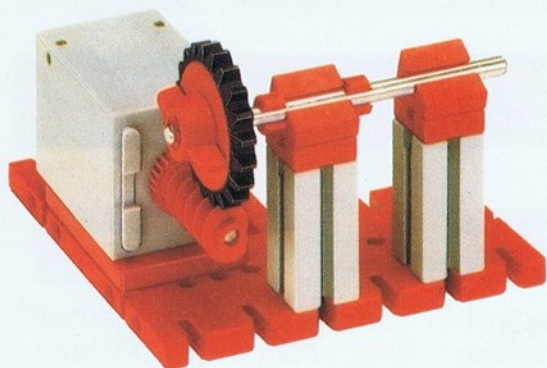
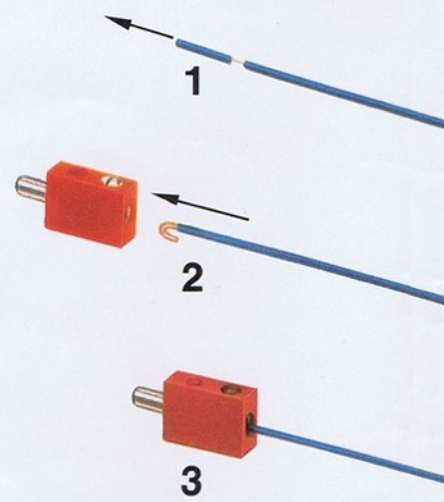
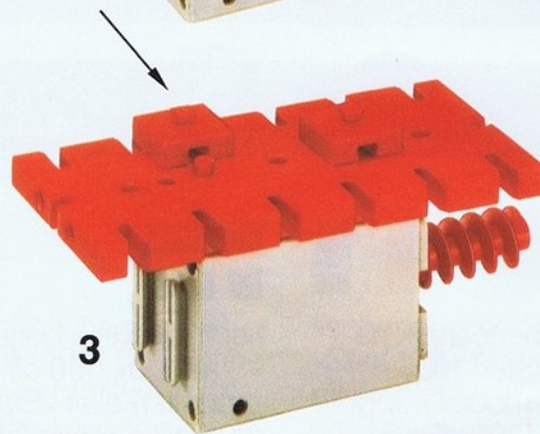
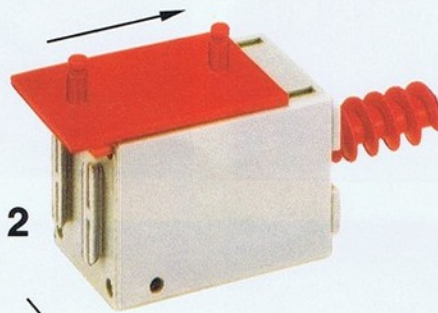
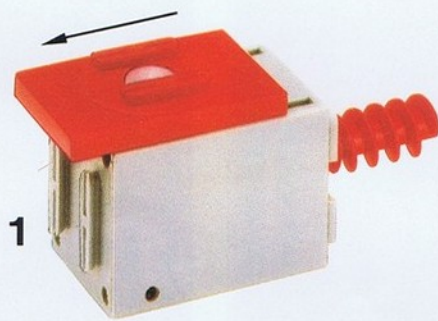
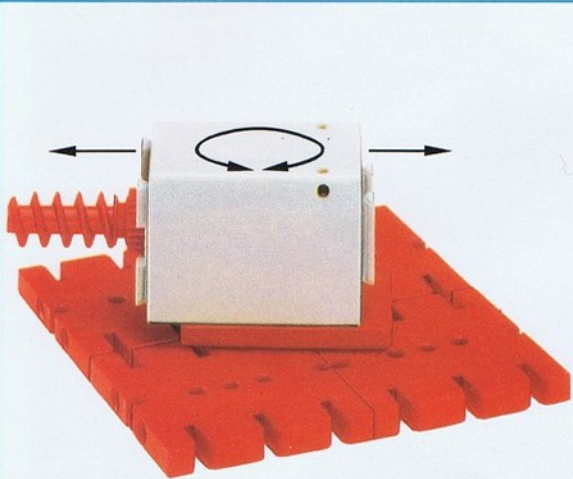
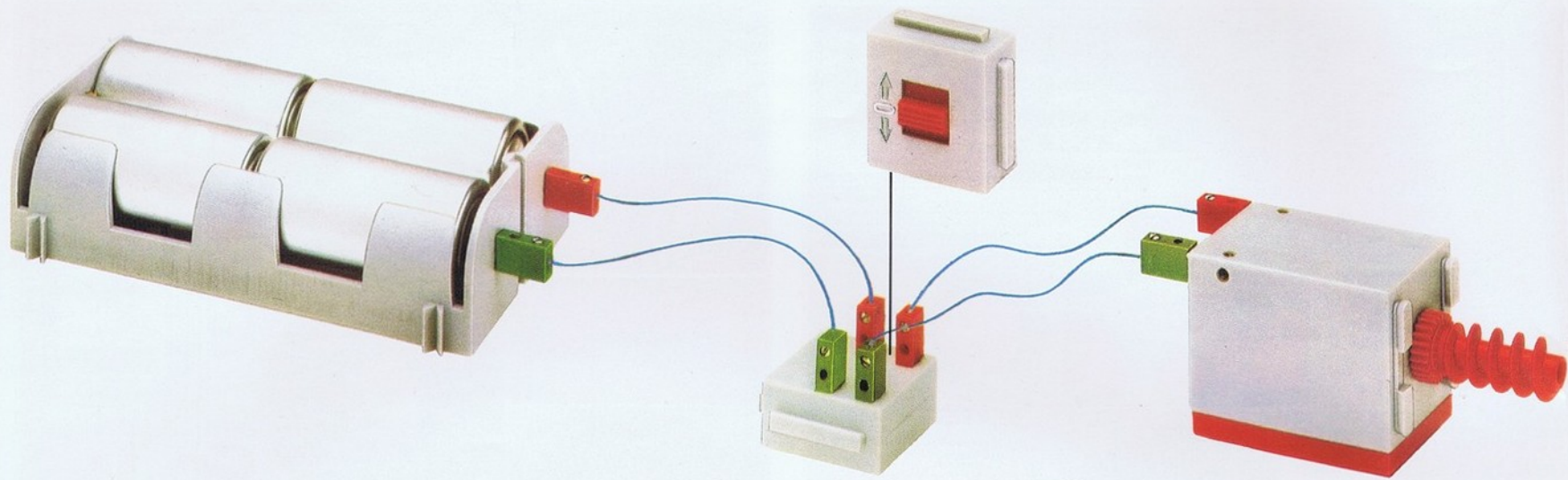

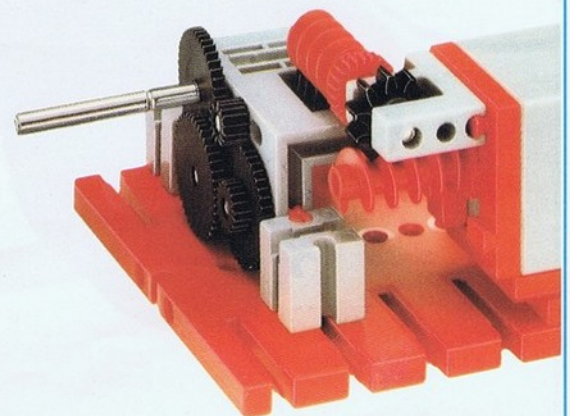
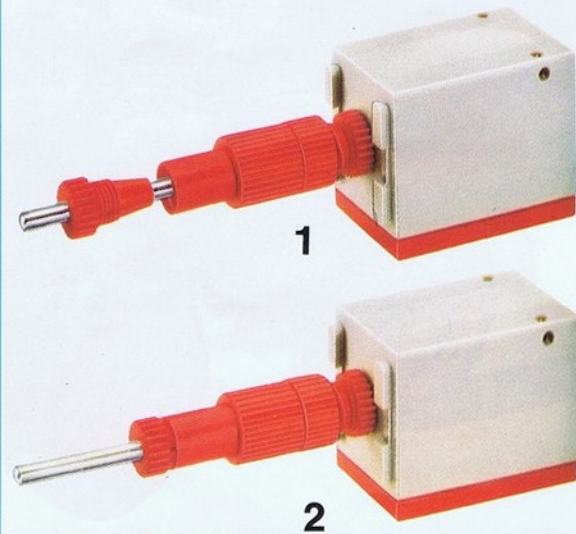
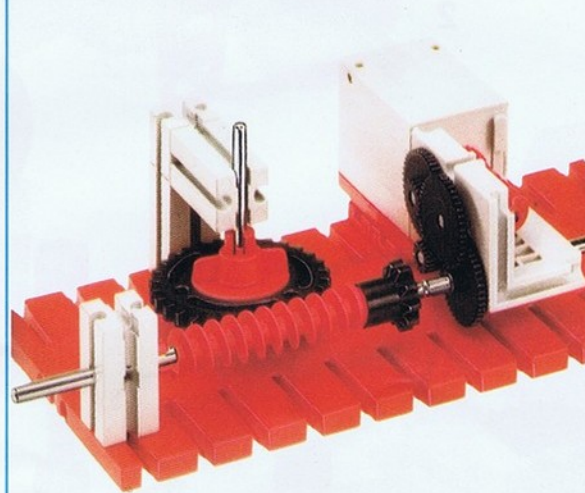
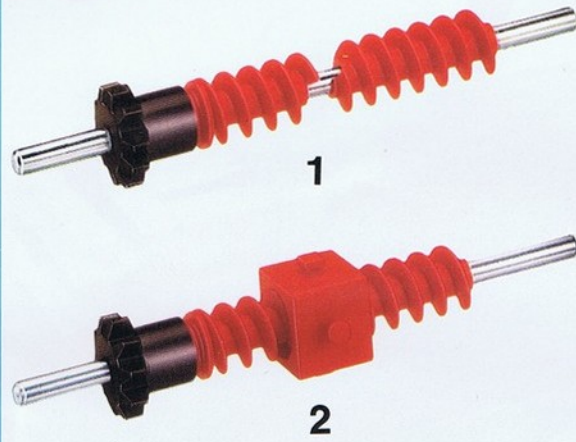
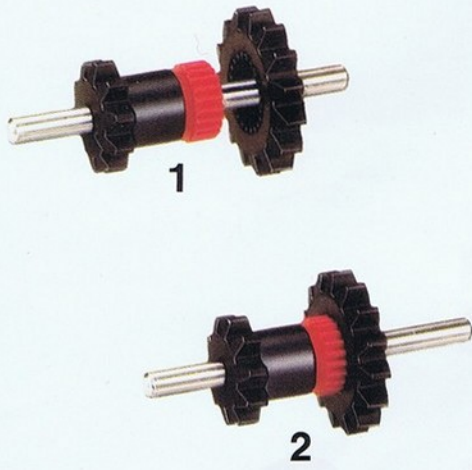
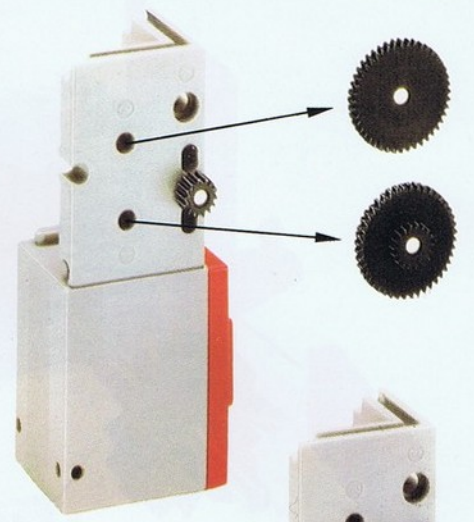
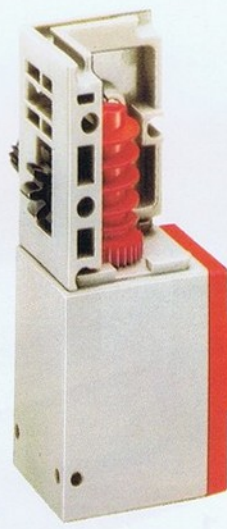
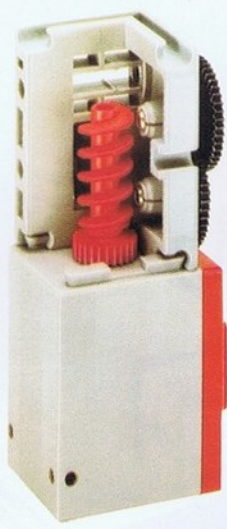

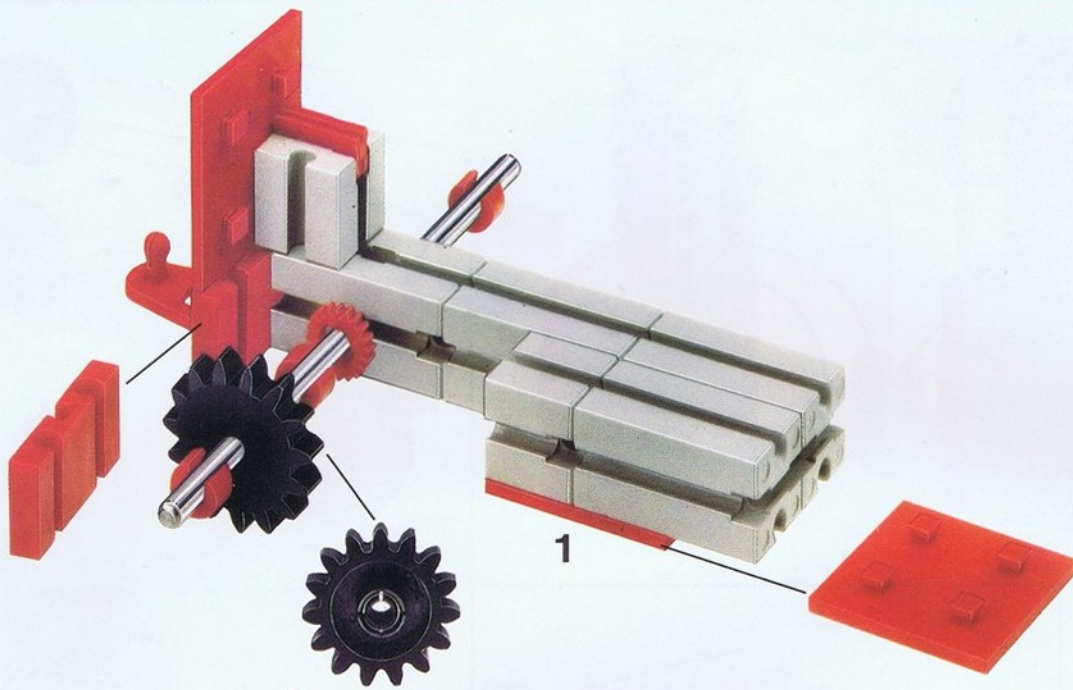

1

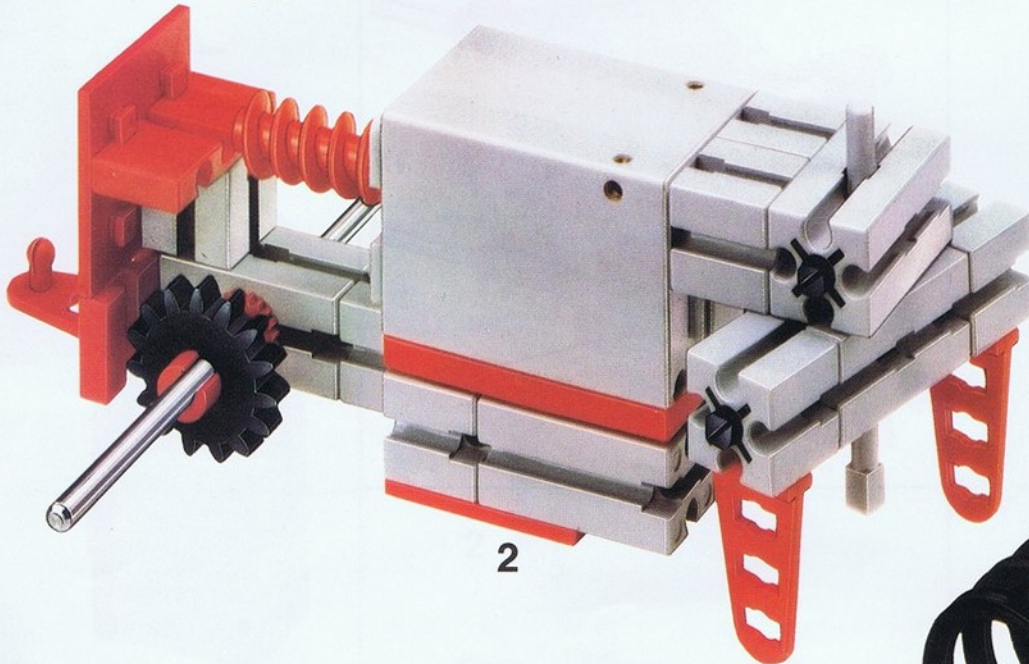

2

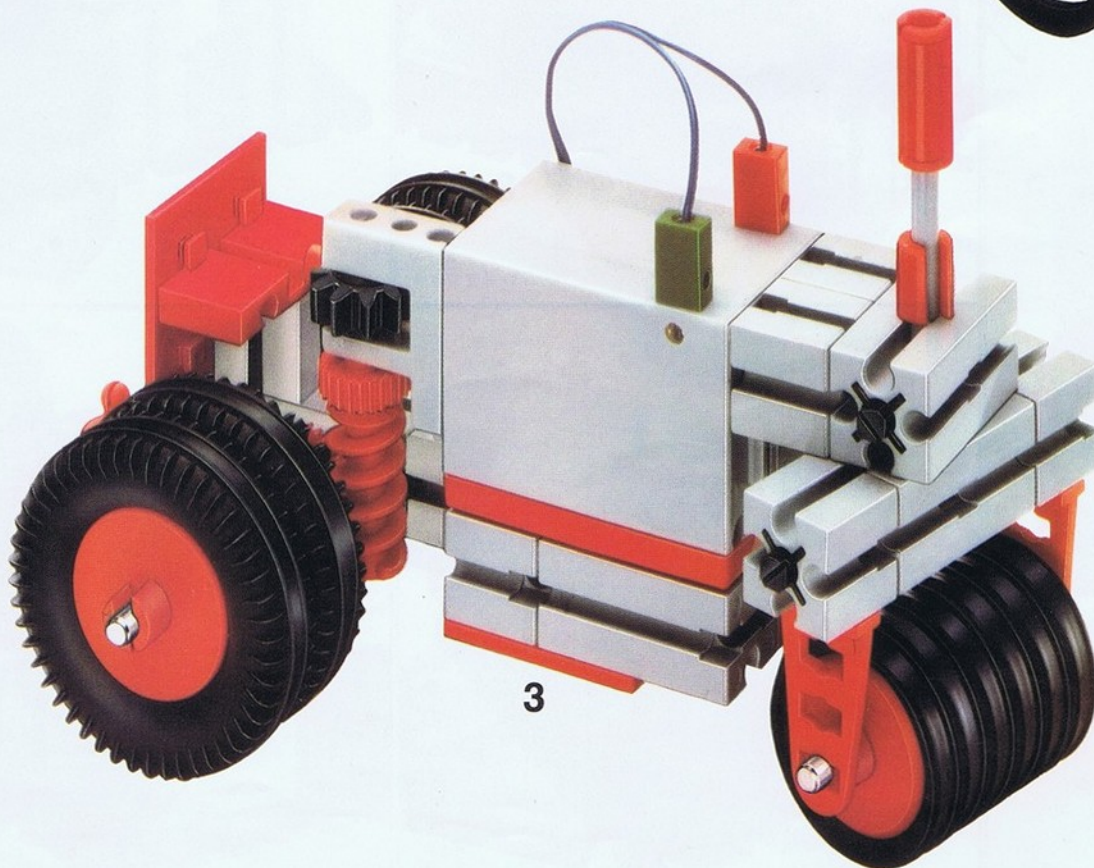

3

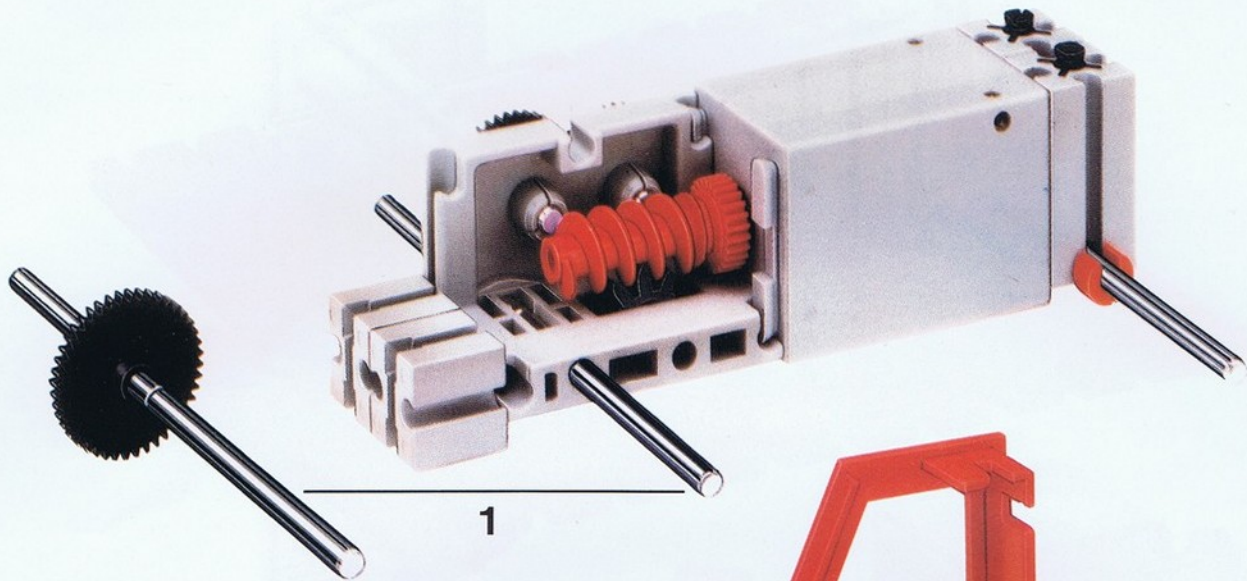

1

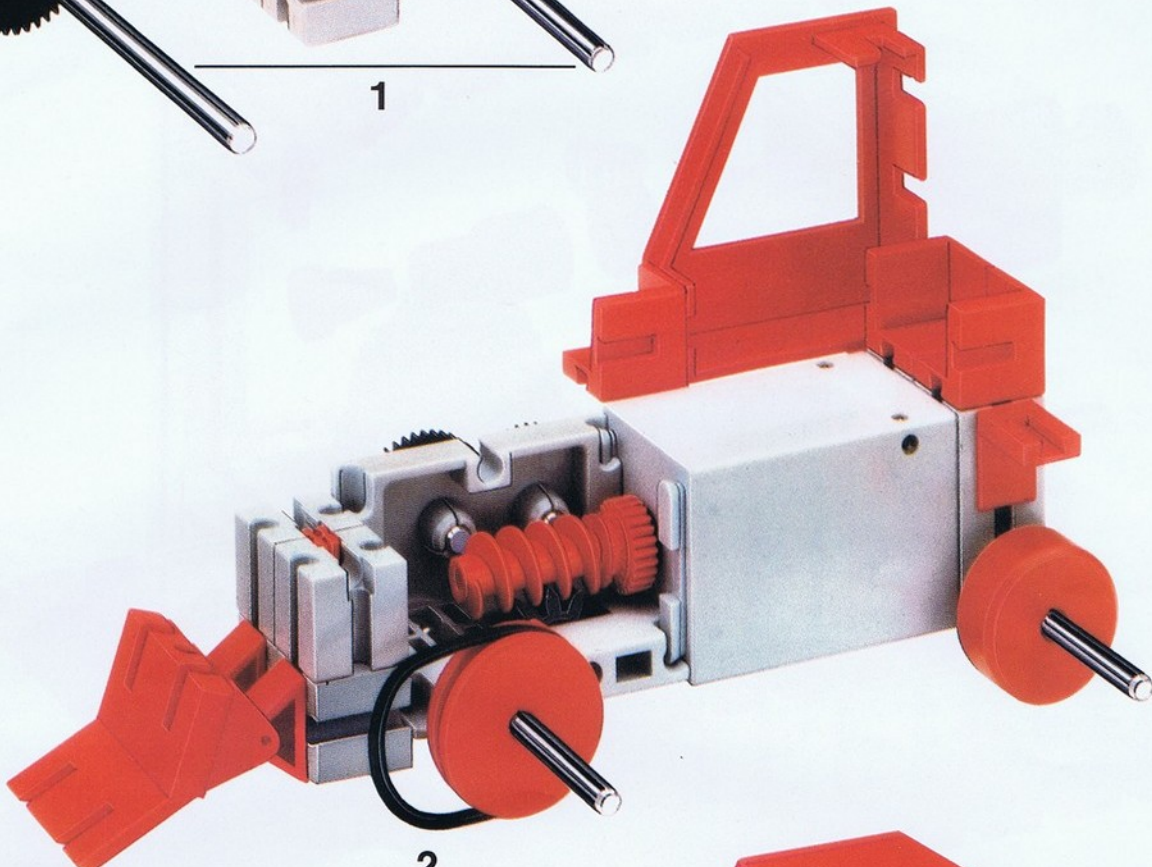

2

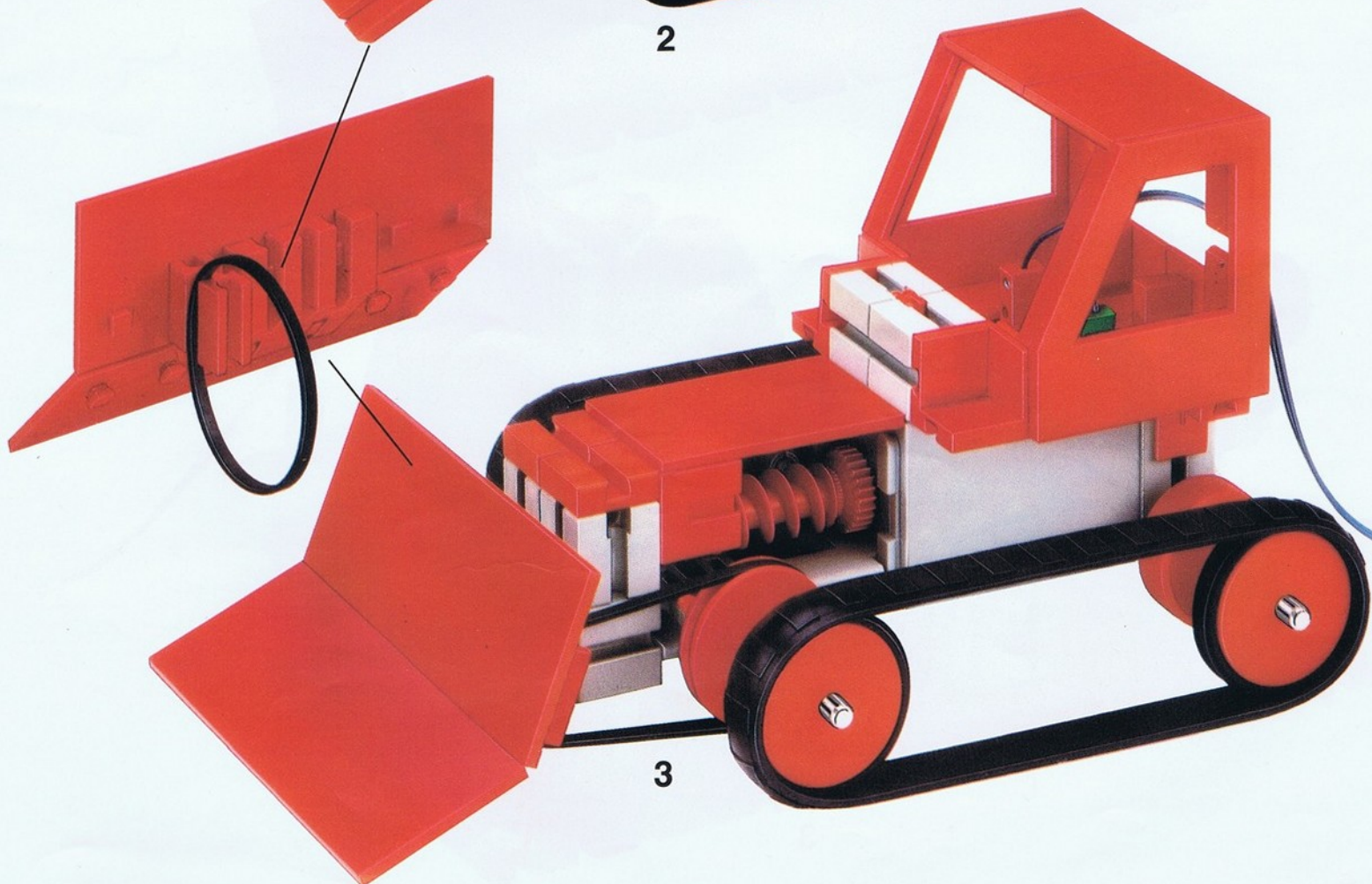

3

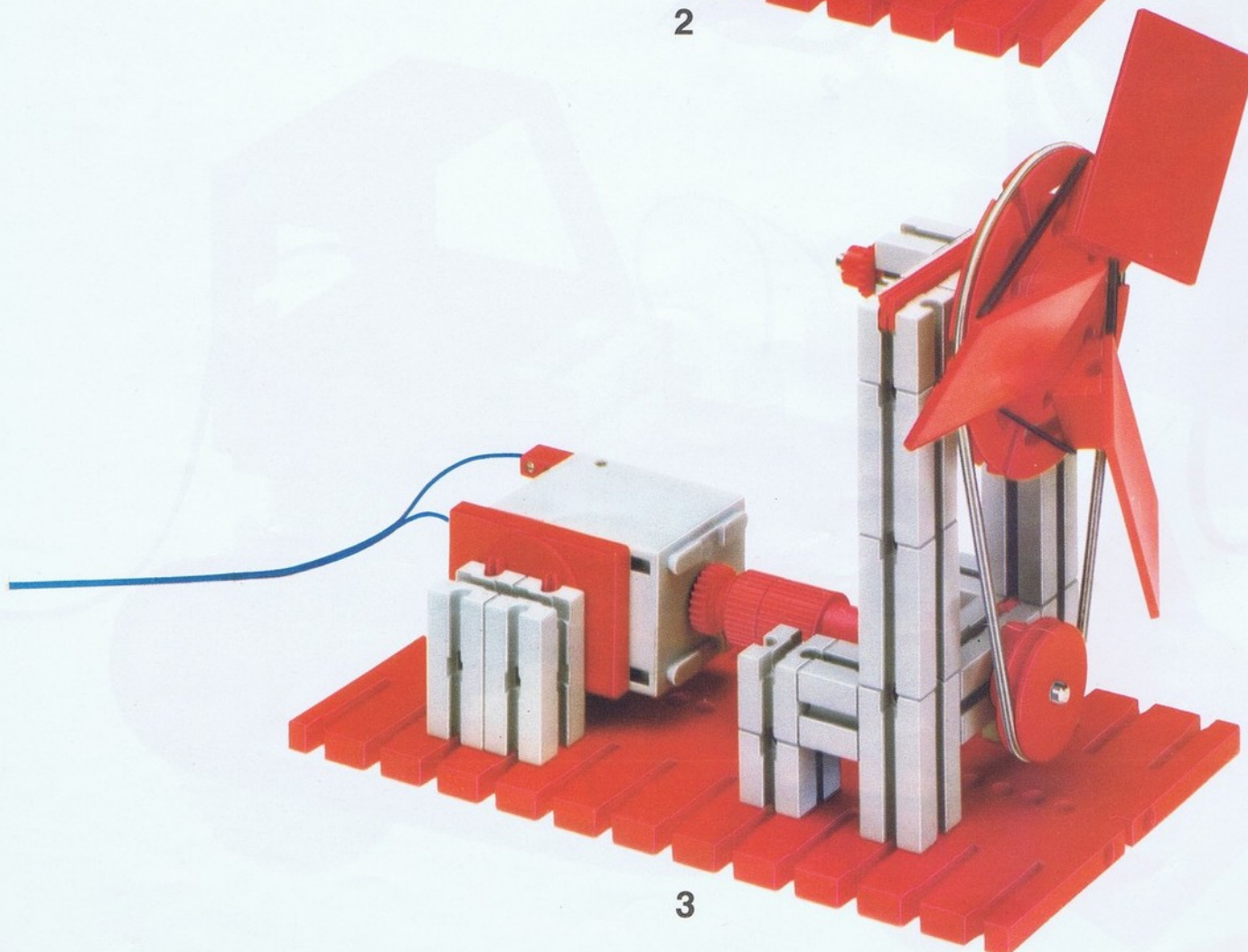
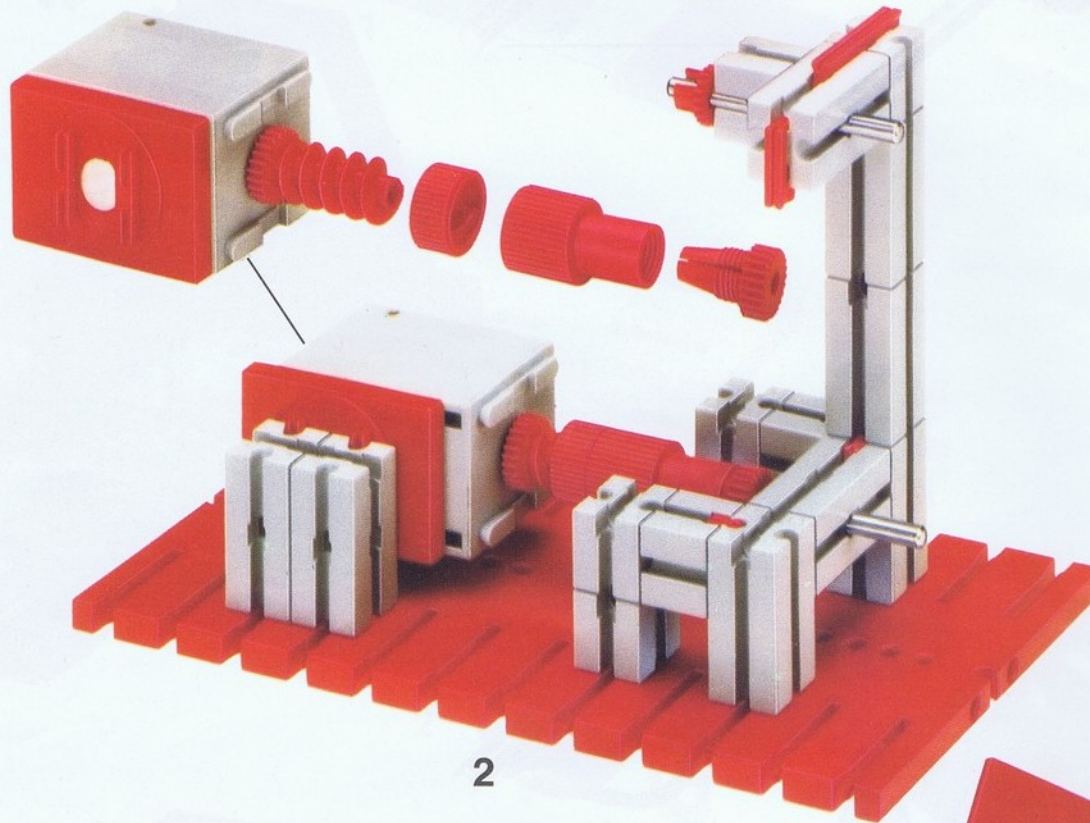
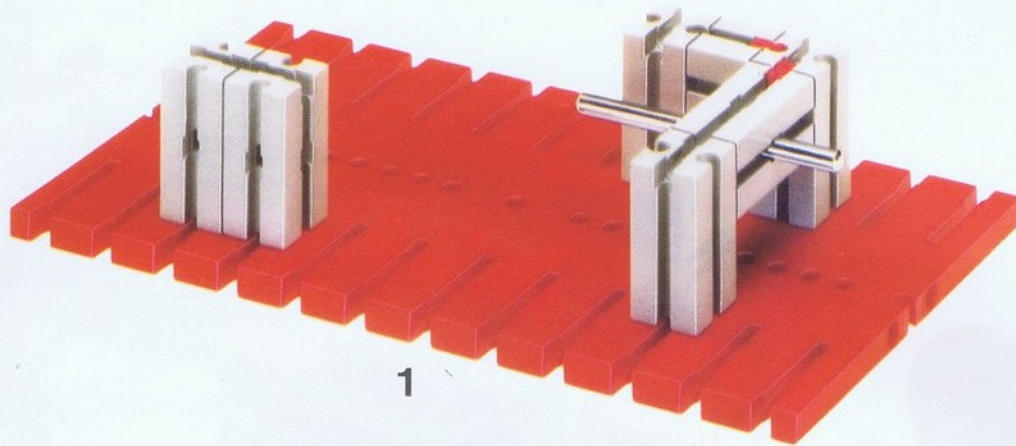

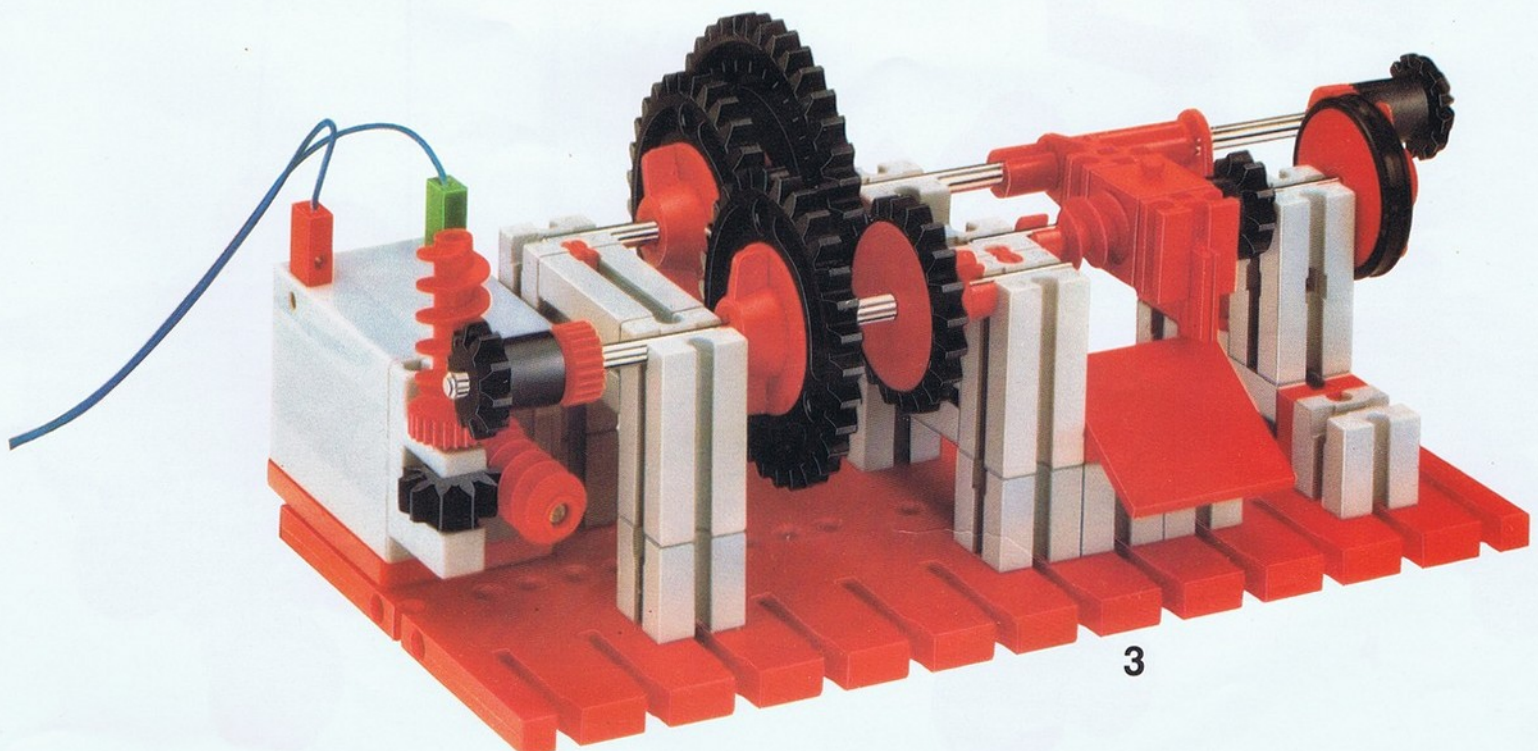
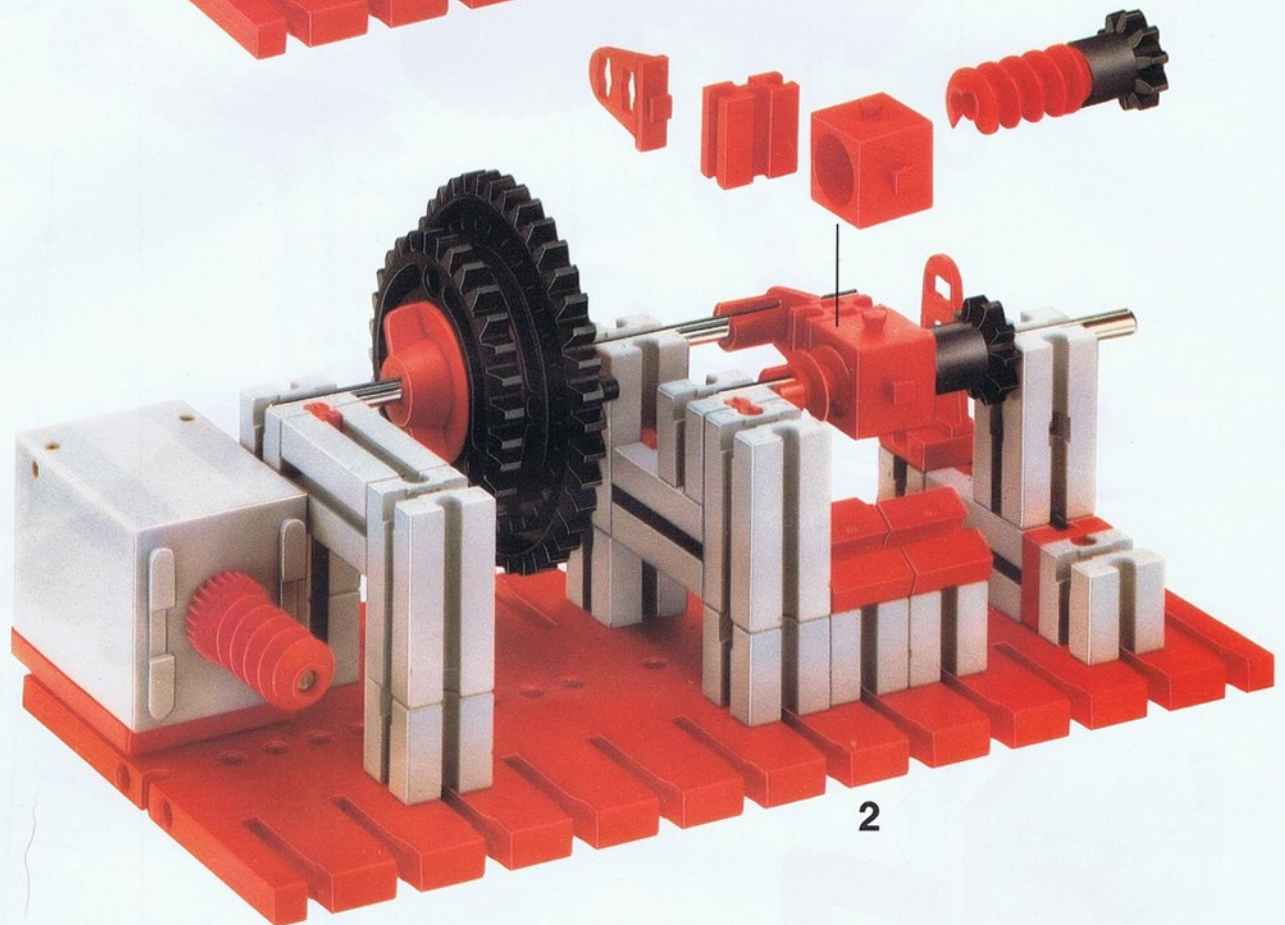
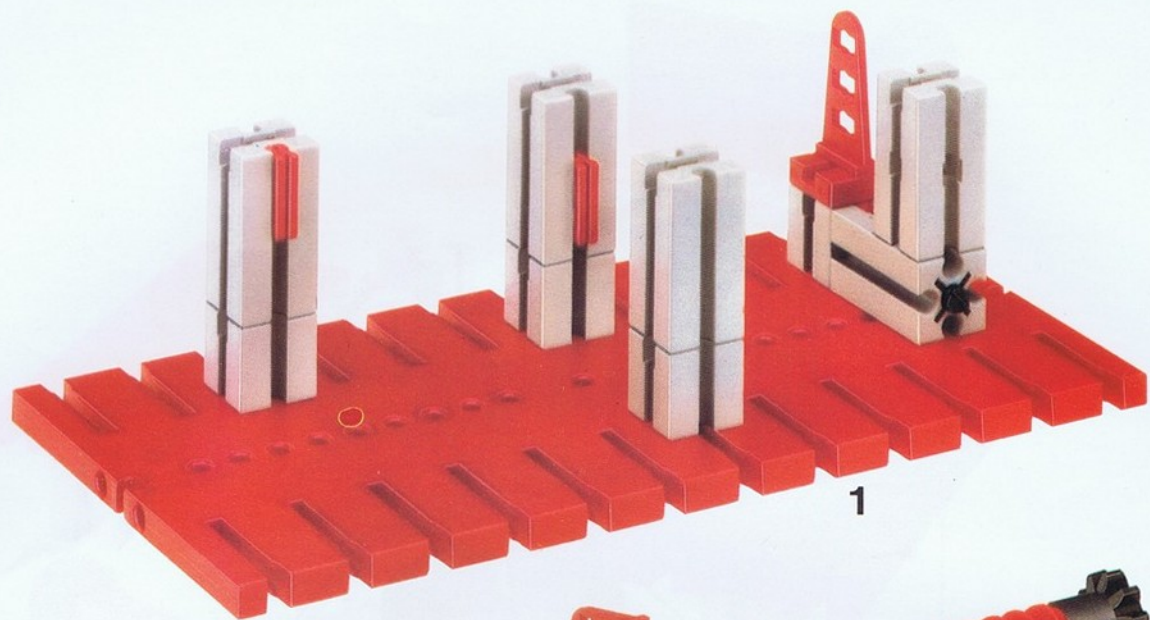

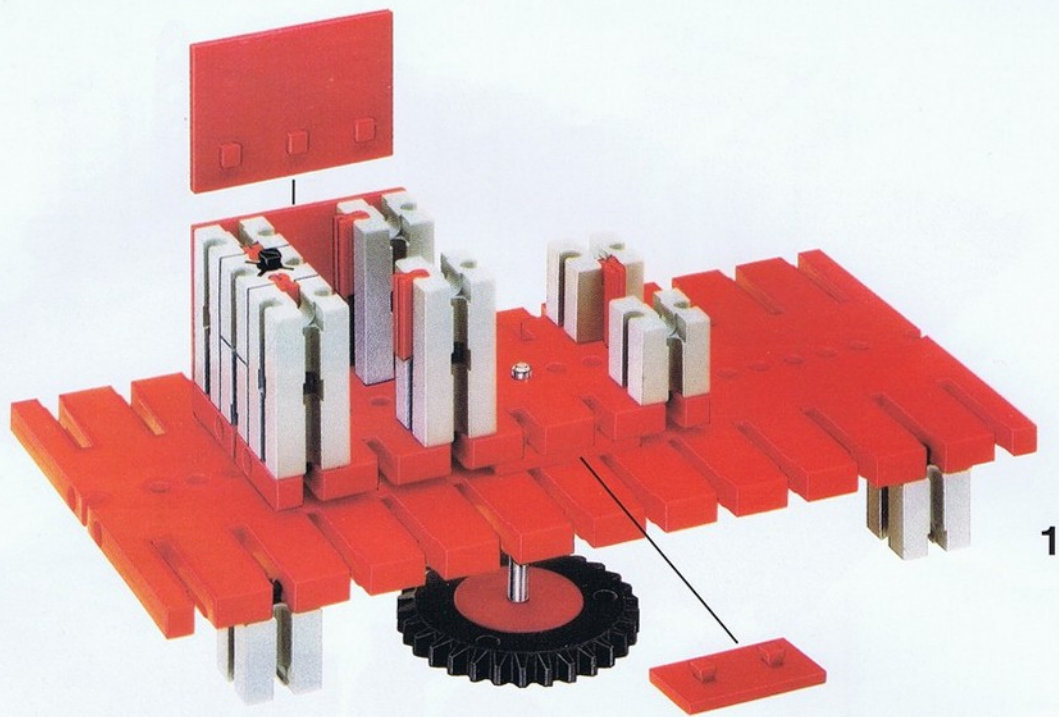

1

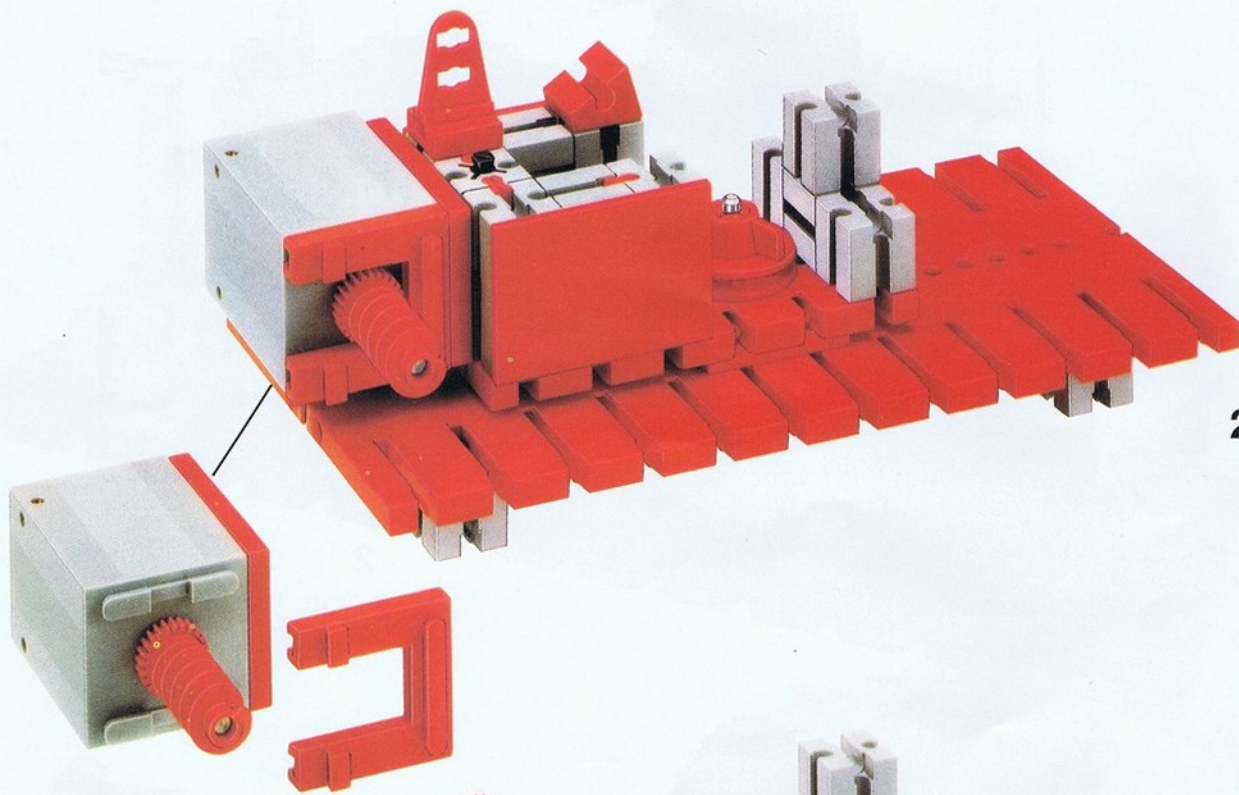

2

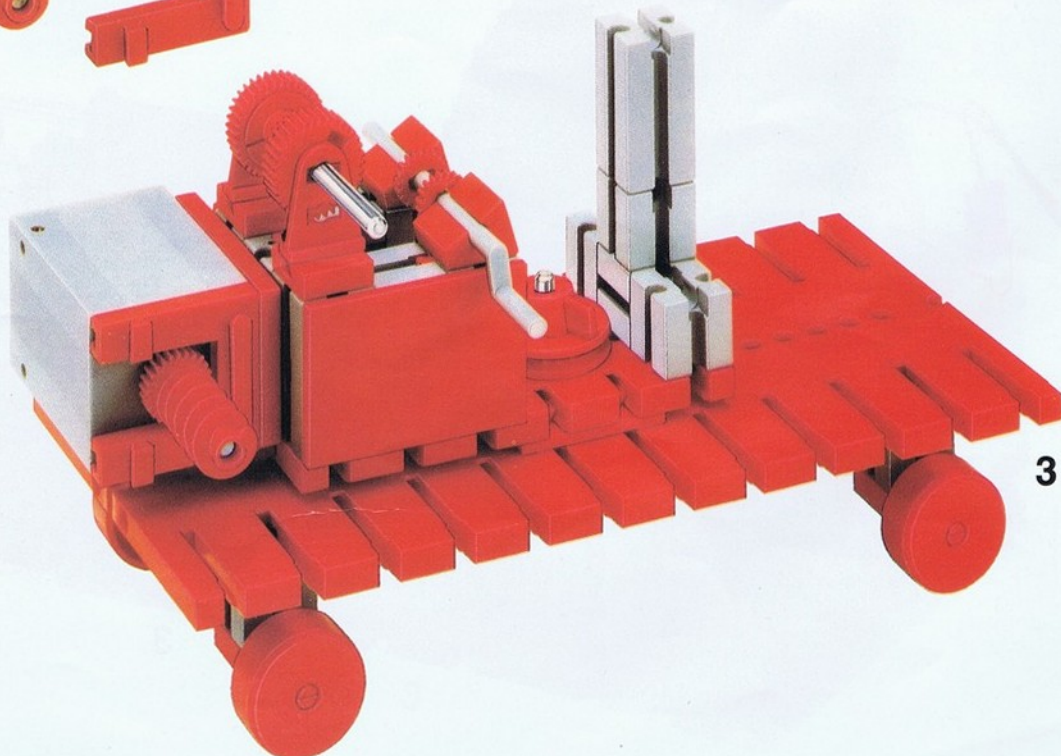

3



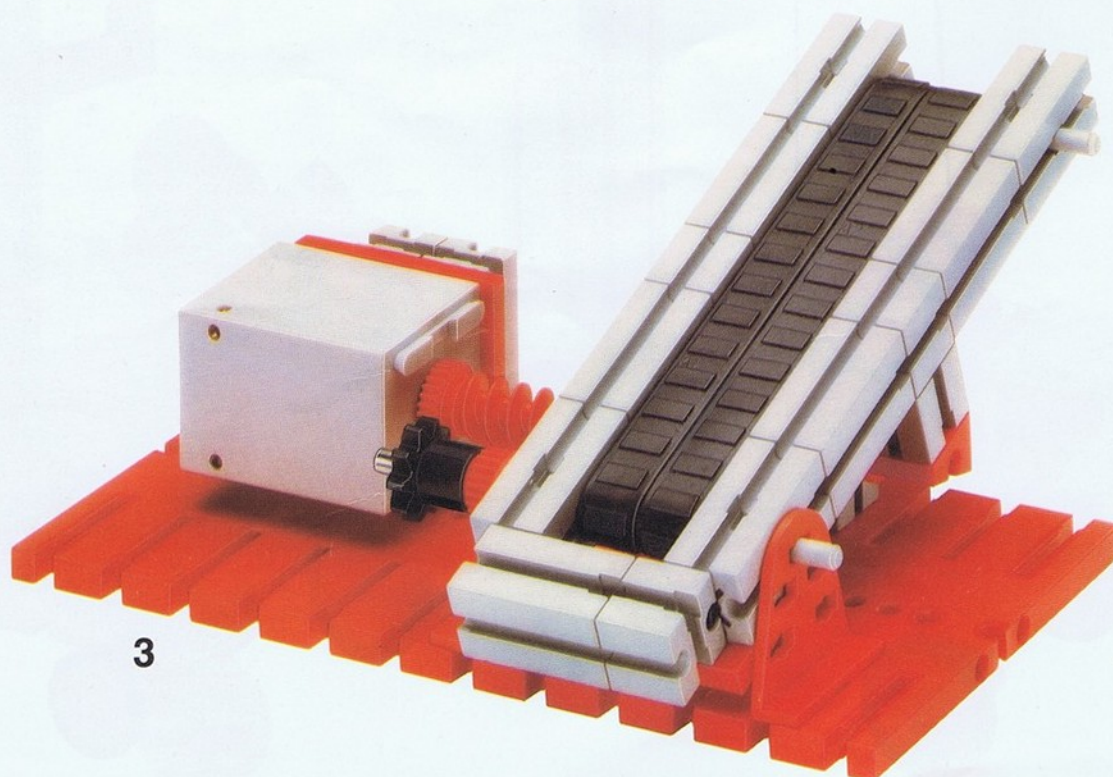
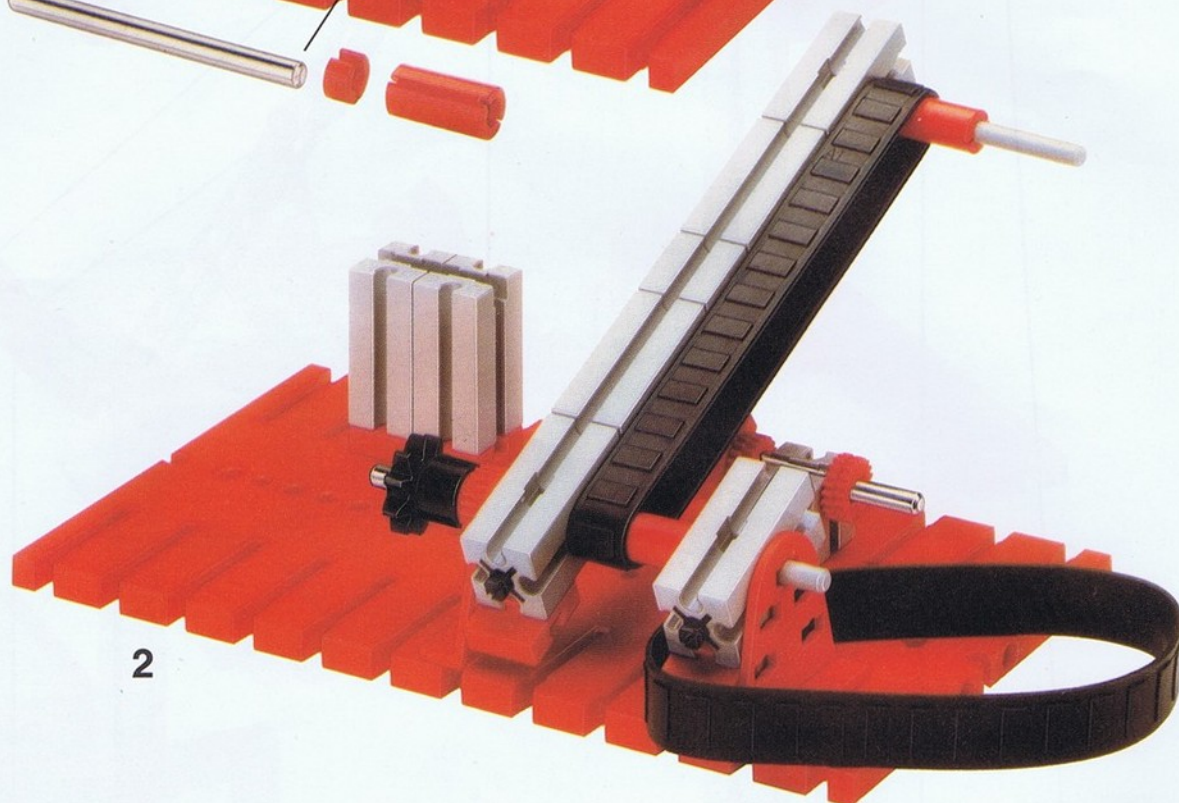
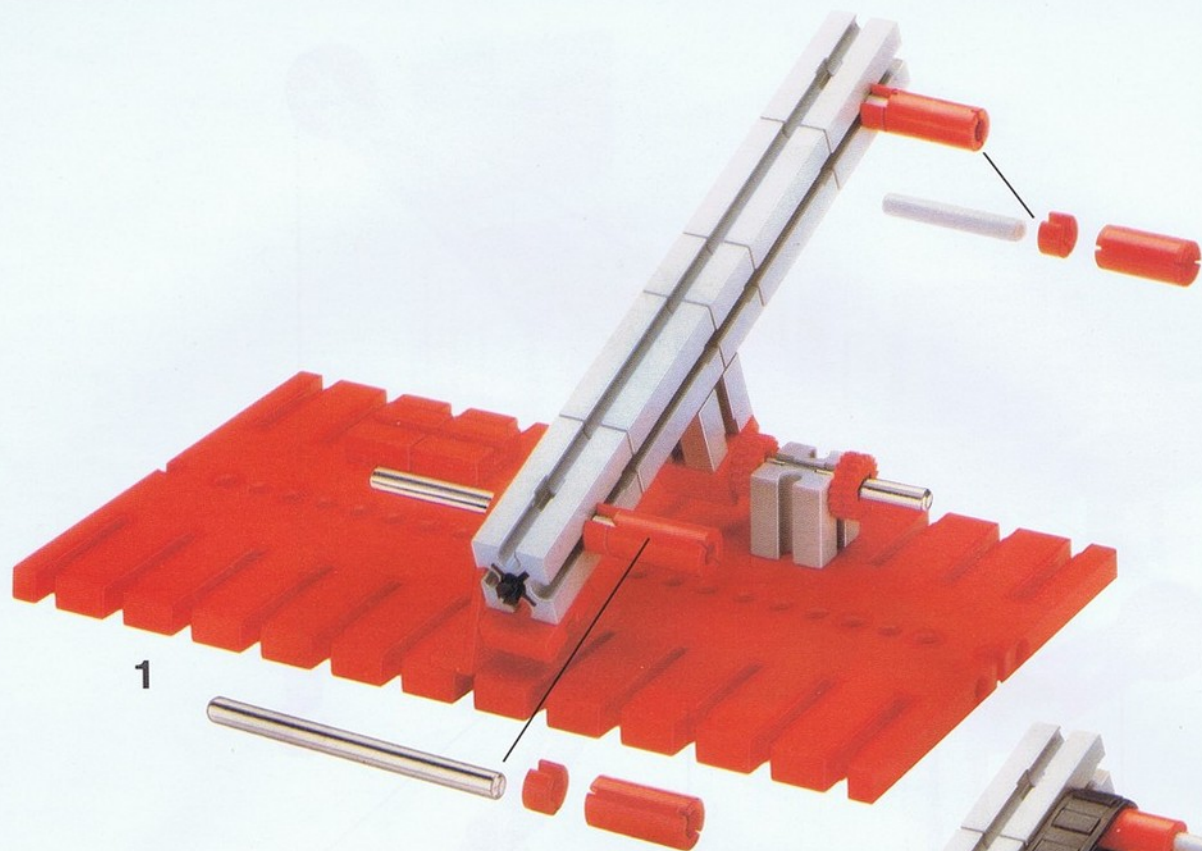

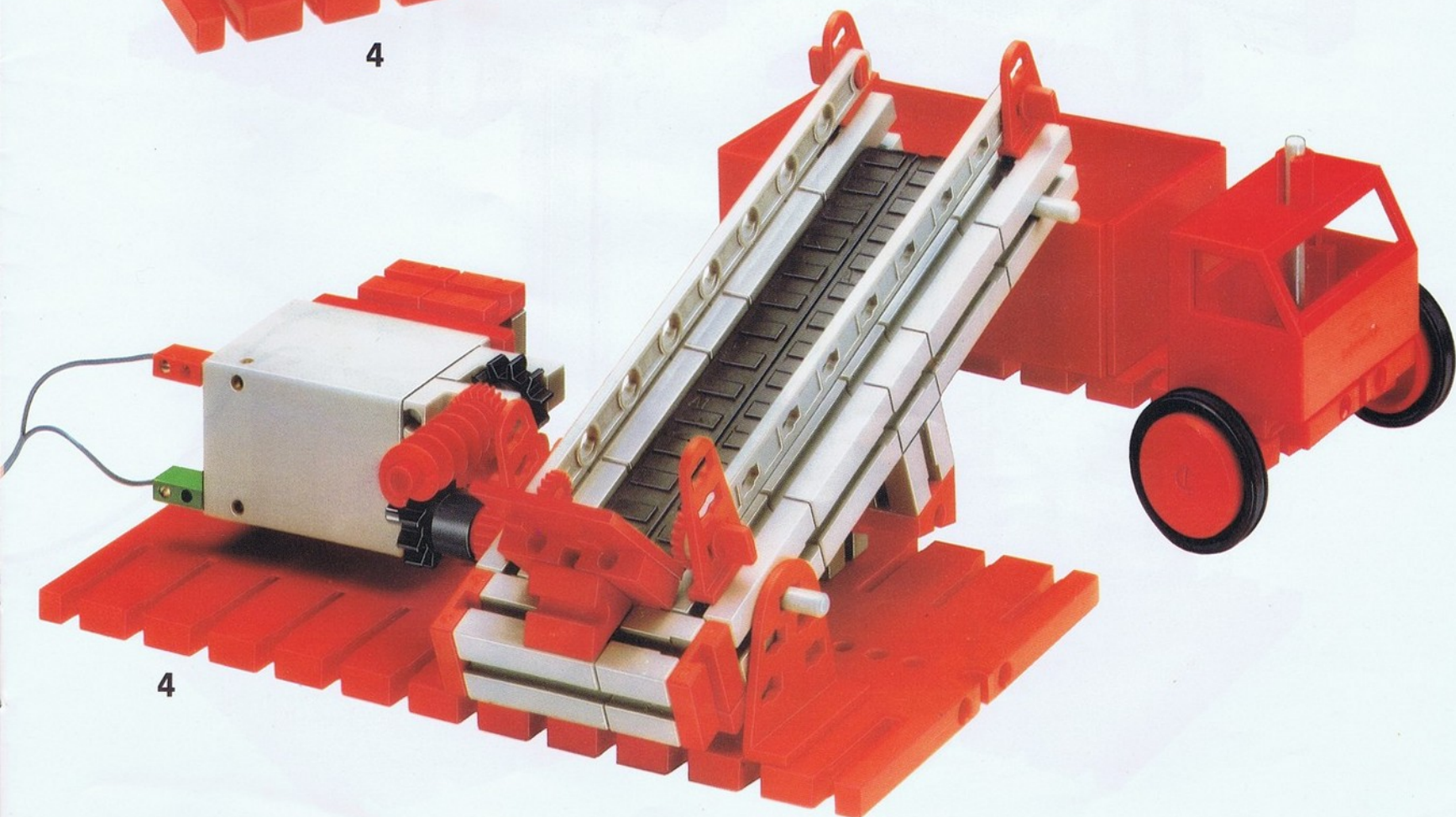
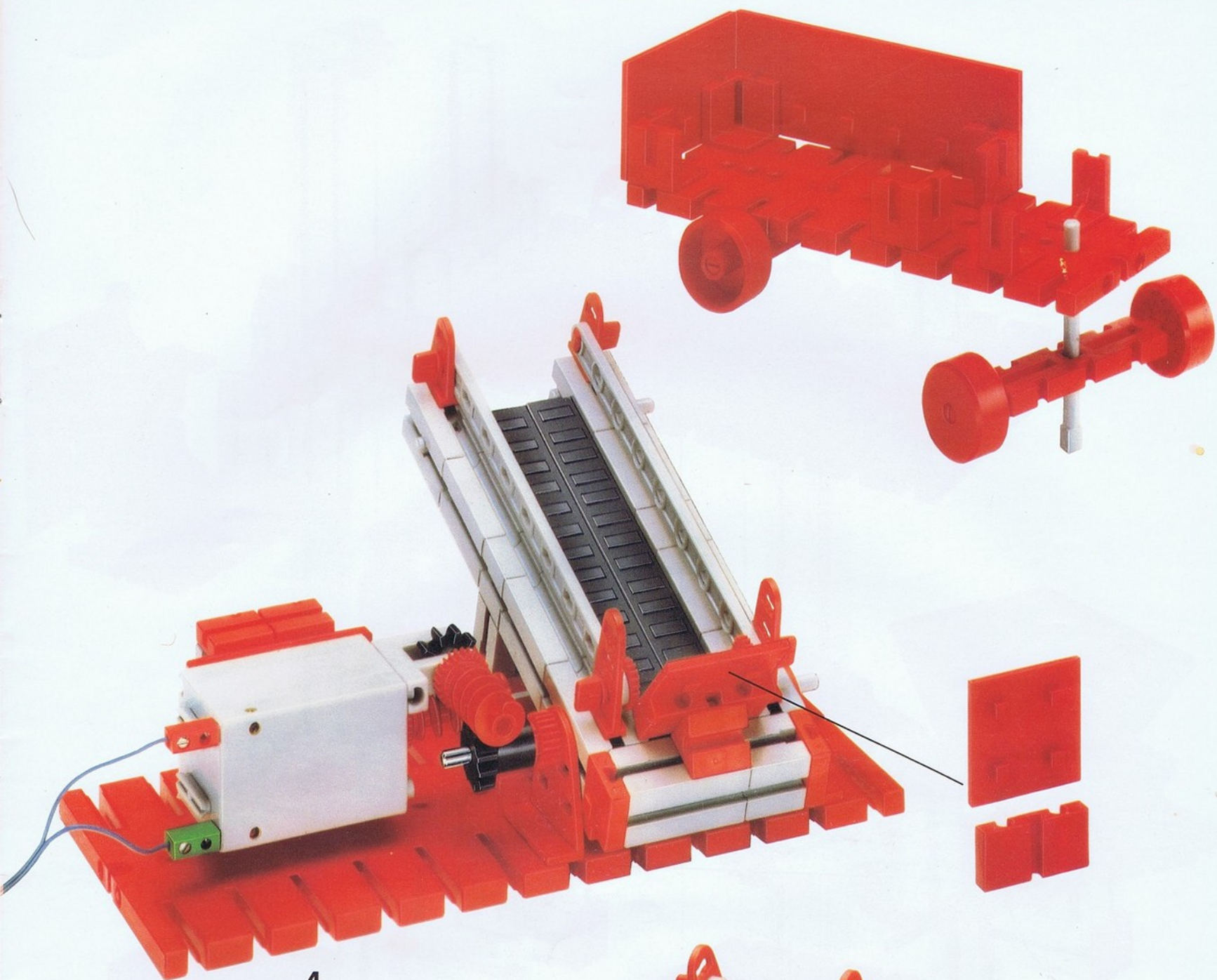

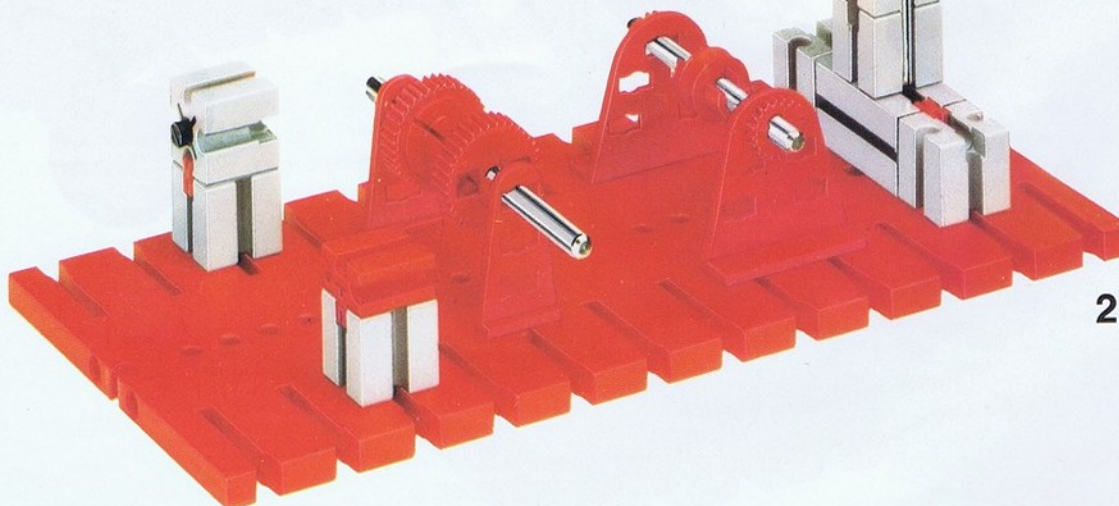
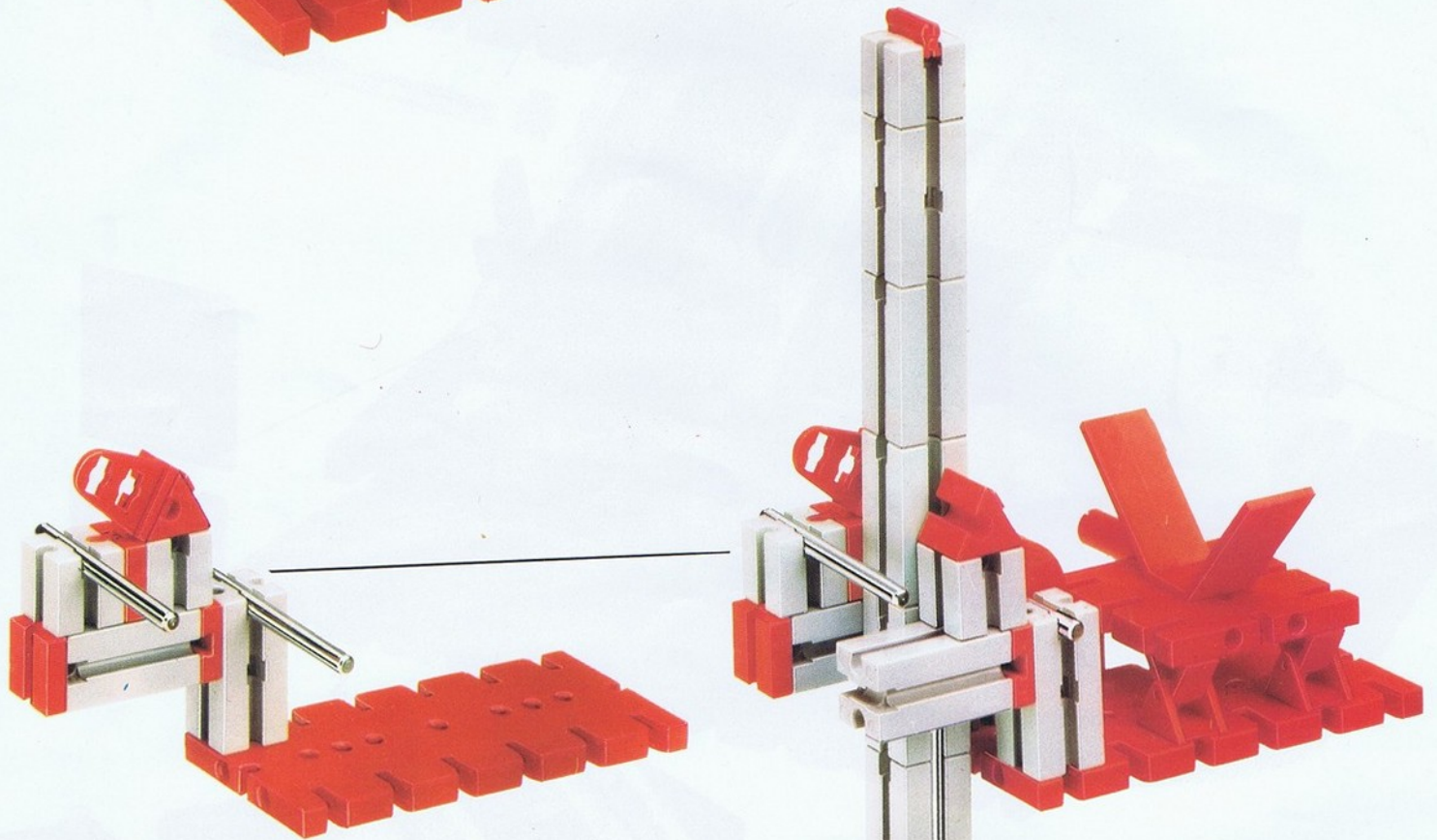
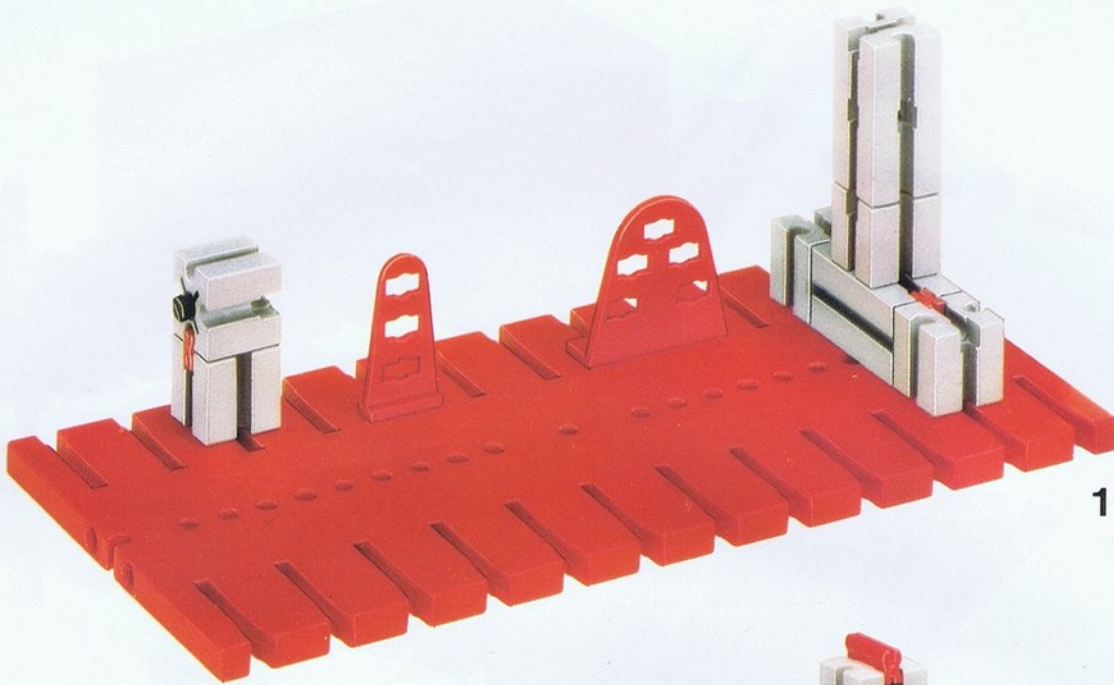

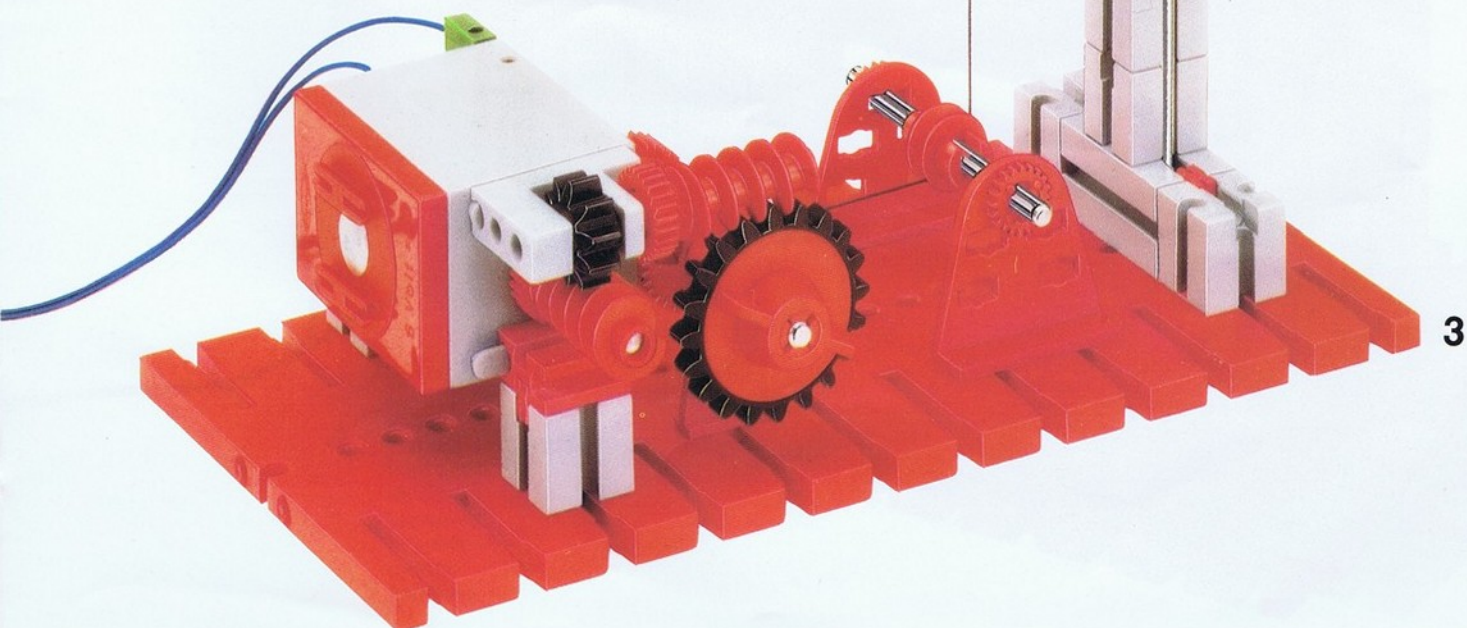
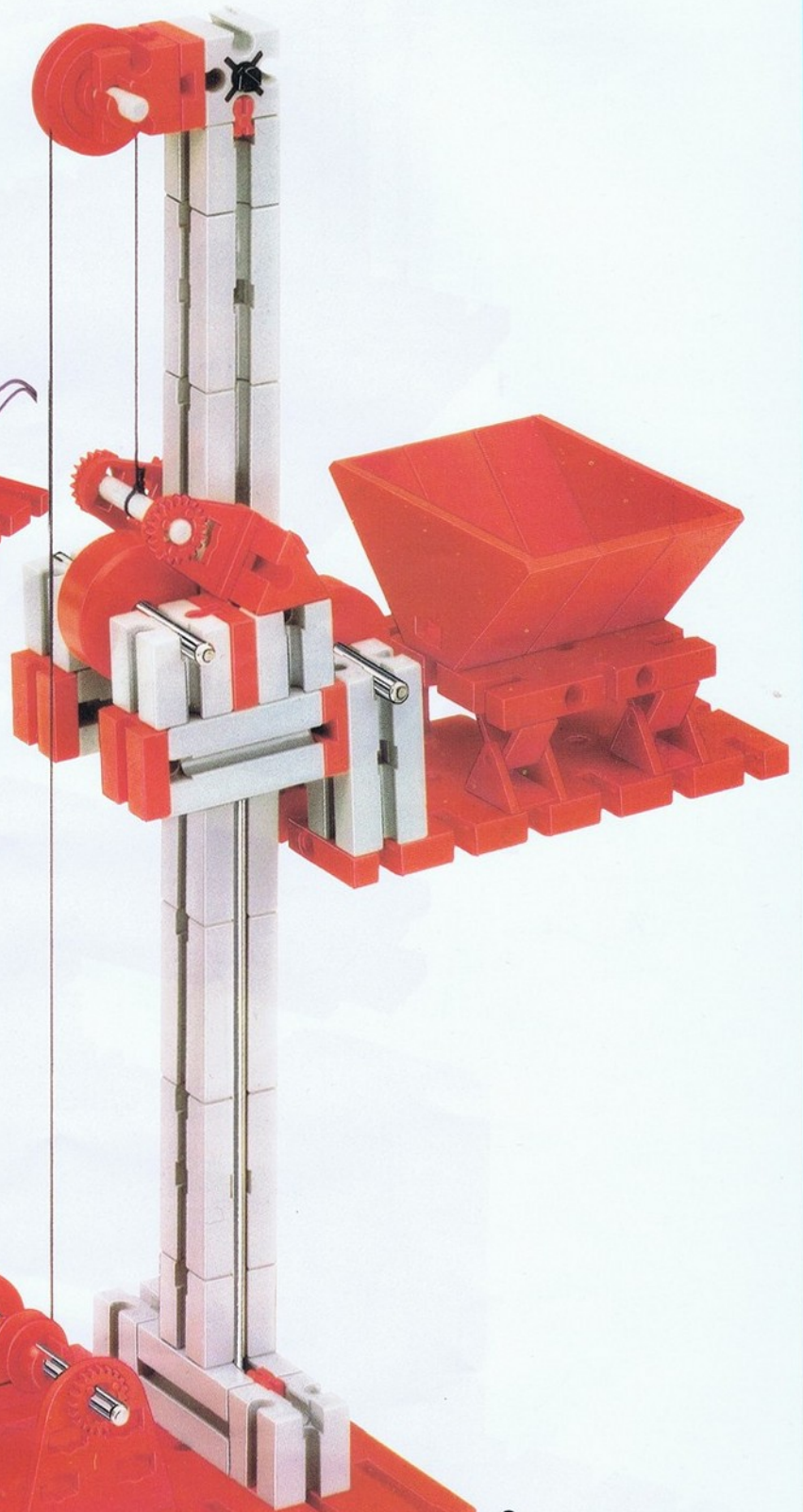
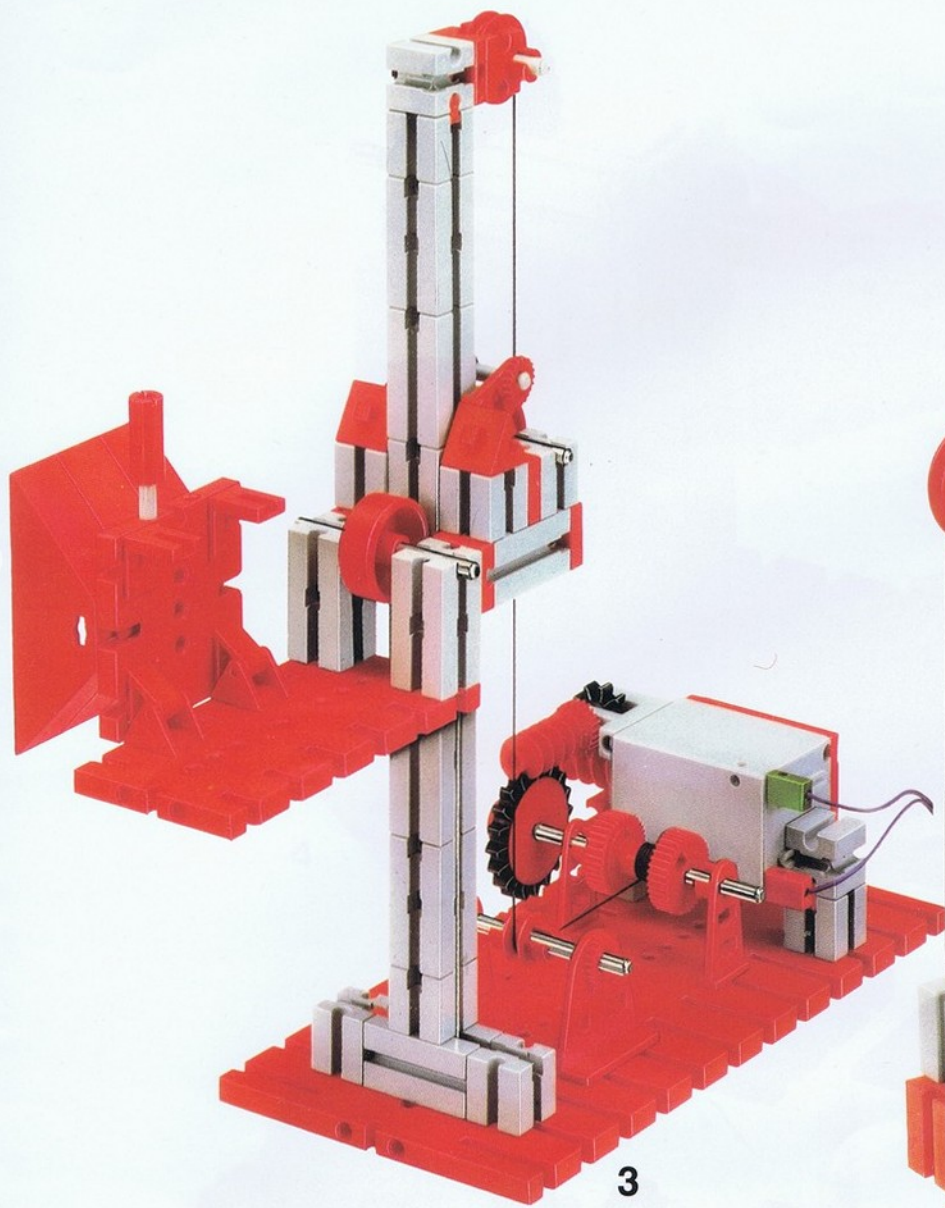

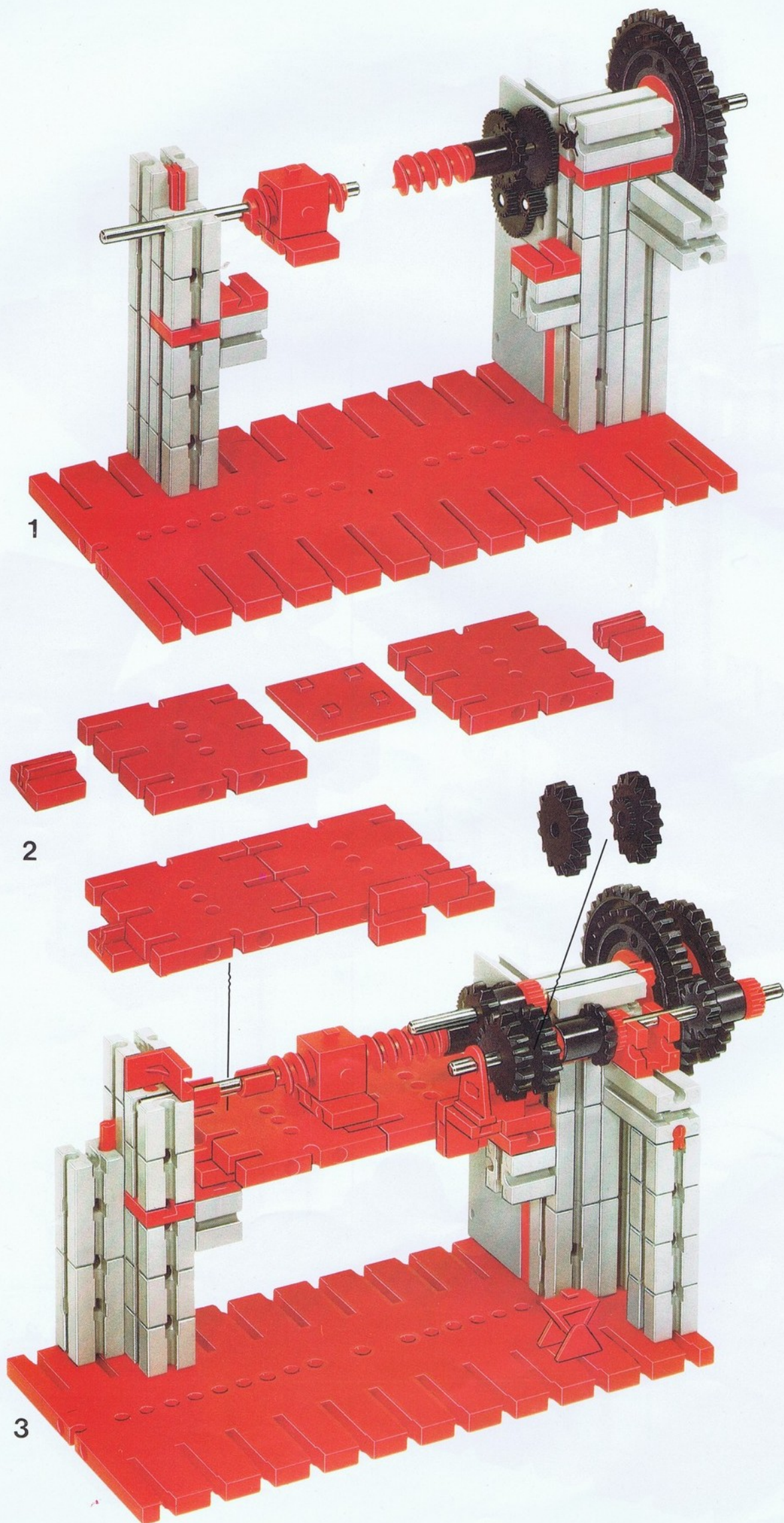

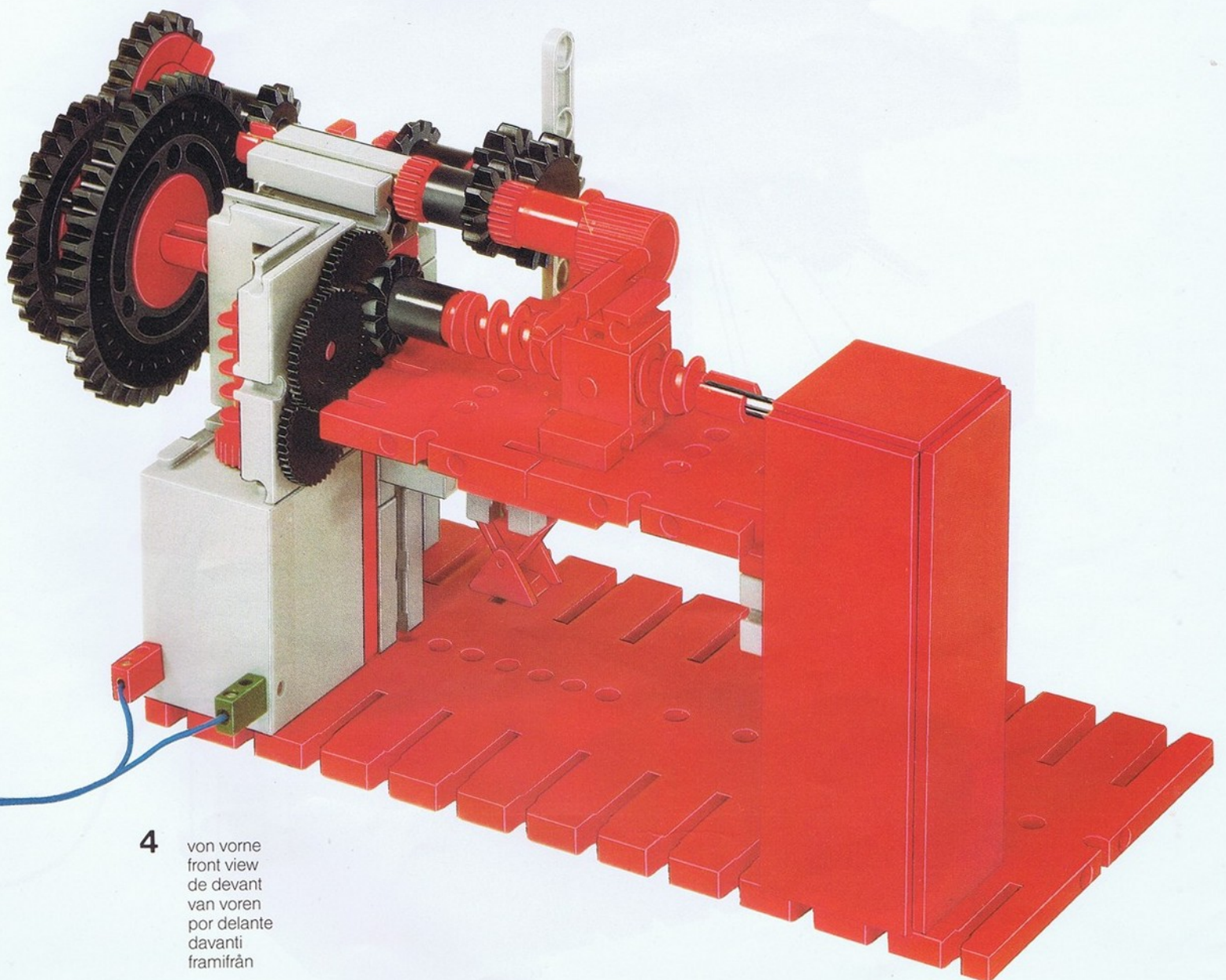
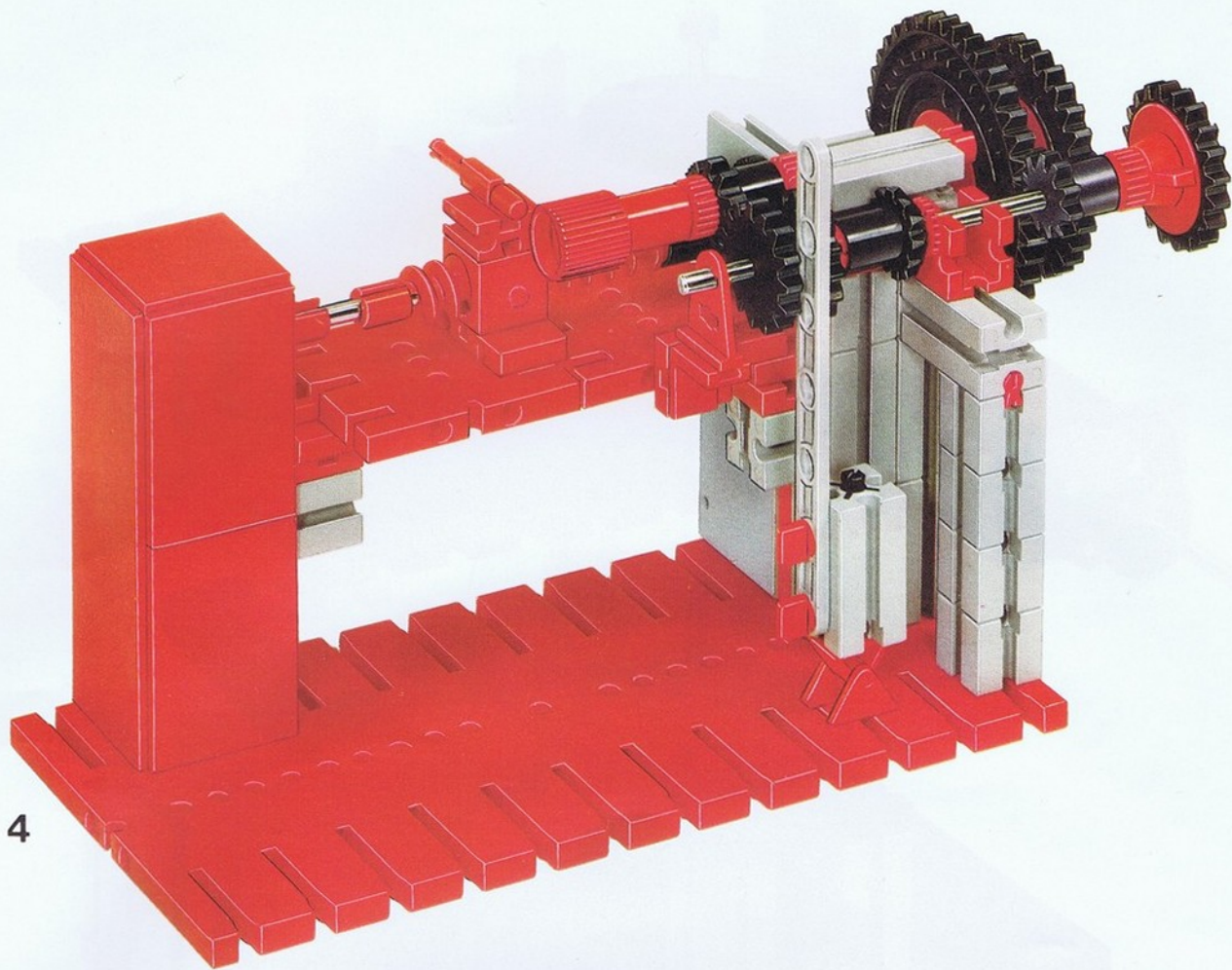

4 von vorne
front view
de devant
van voren
por delante
davanti
framifrån

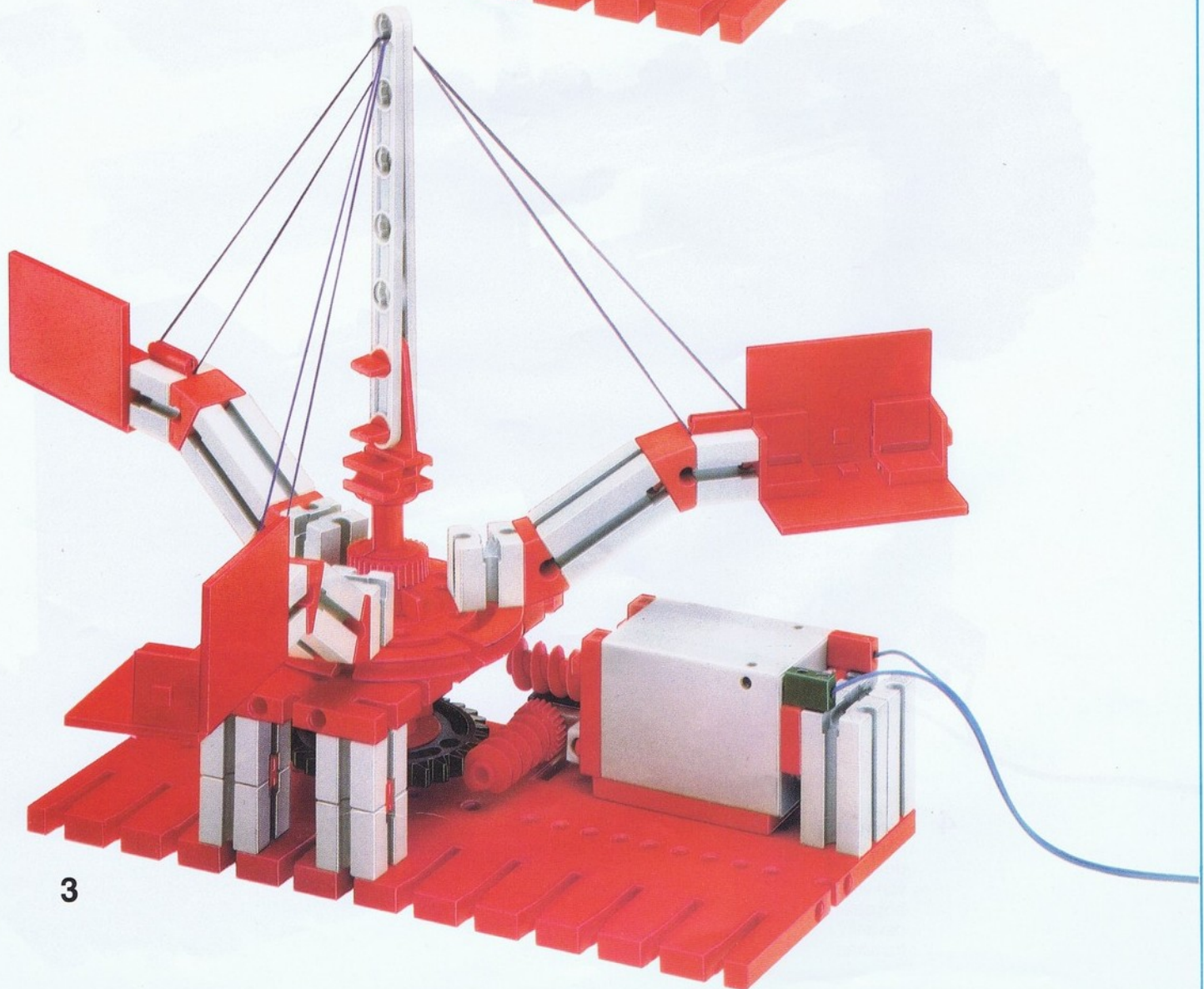
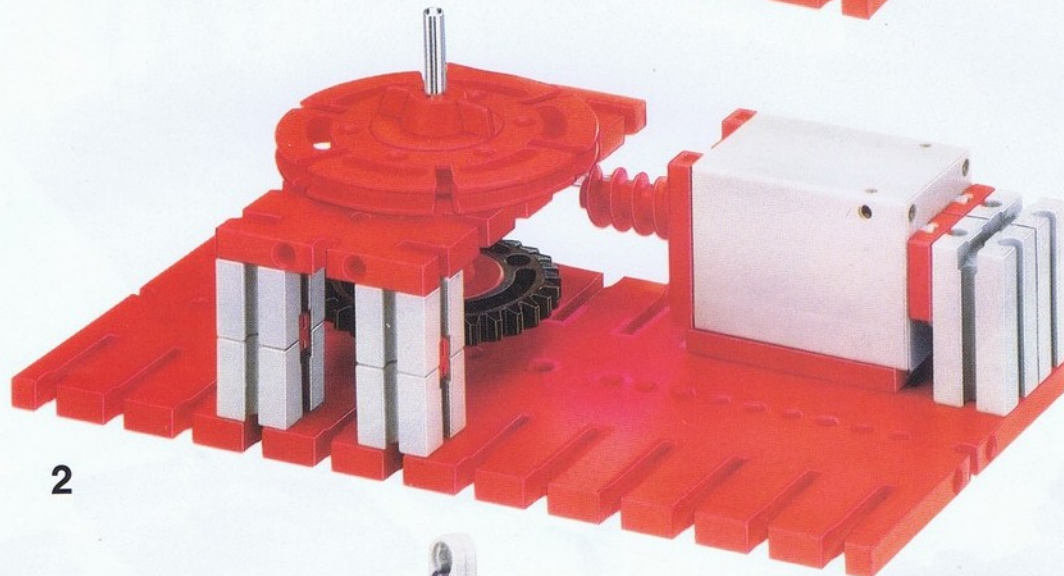
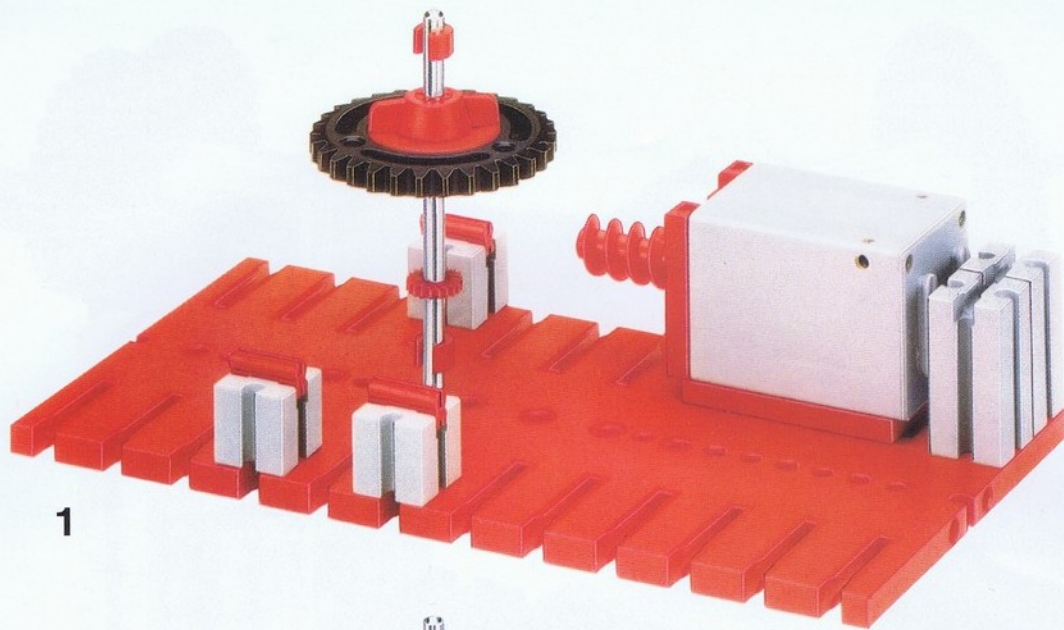

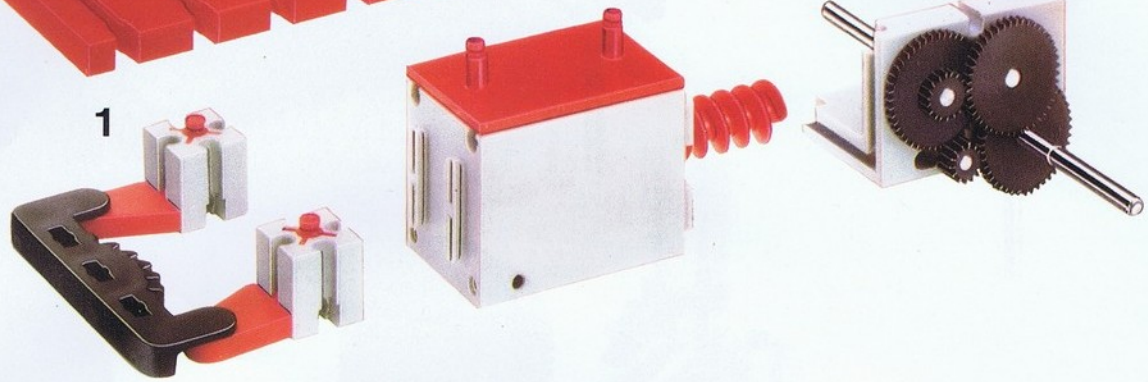
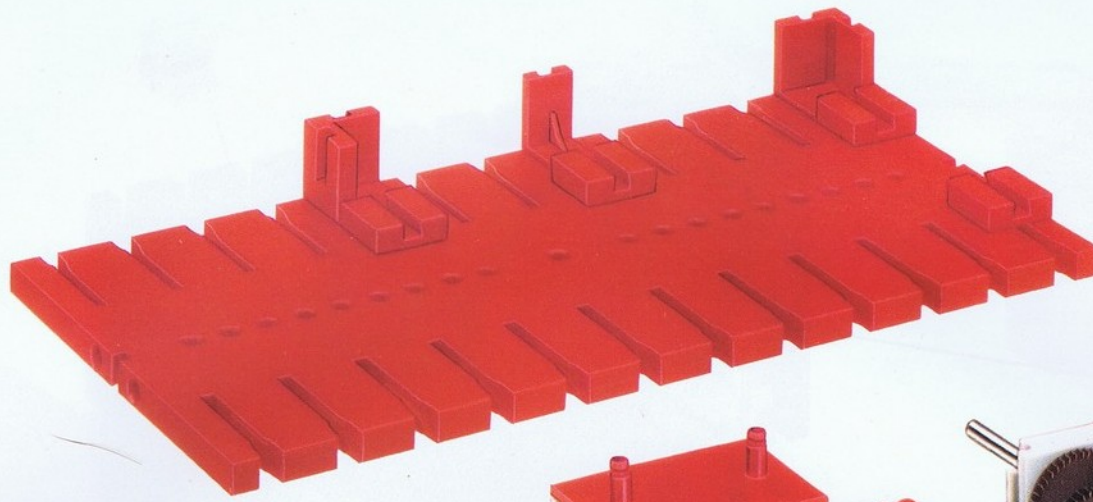

1

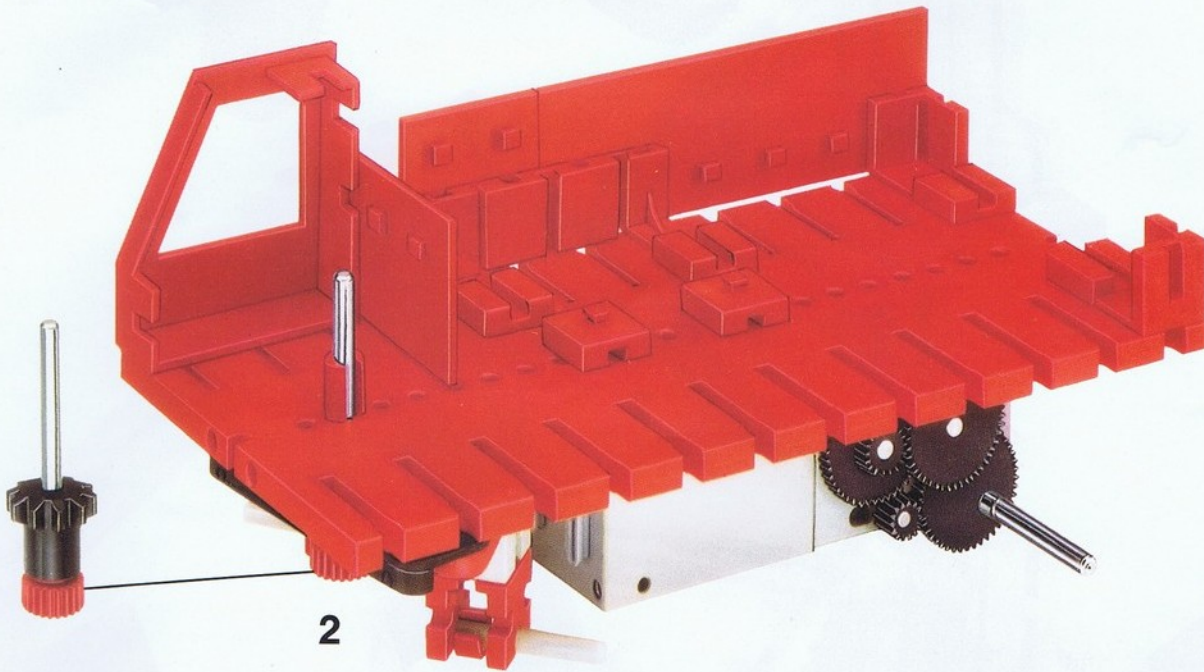

2



3

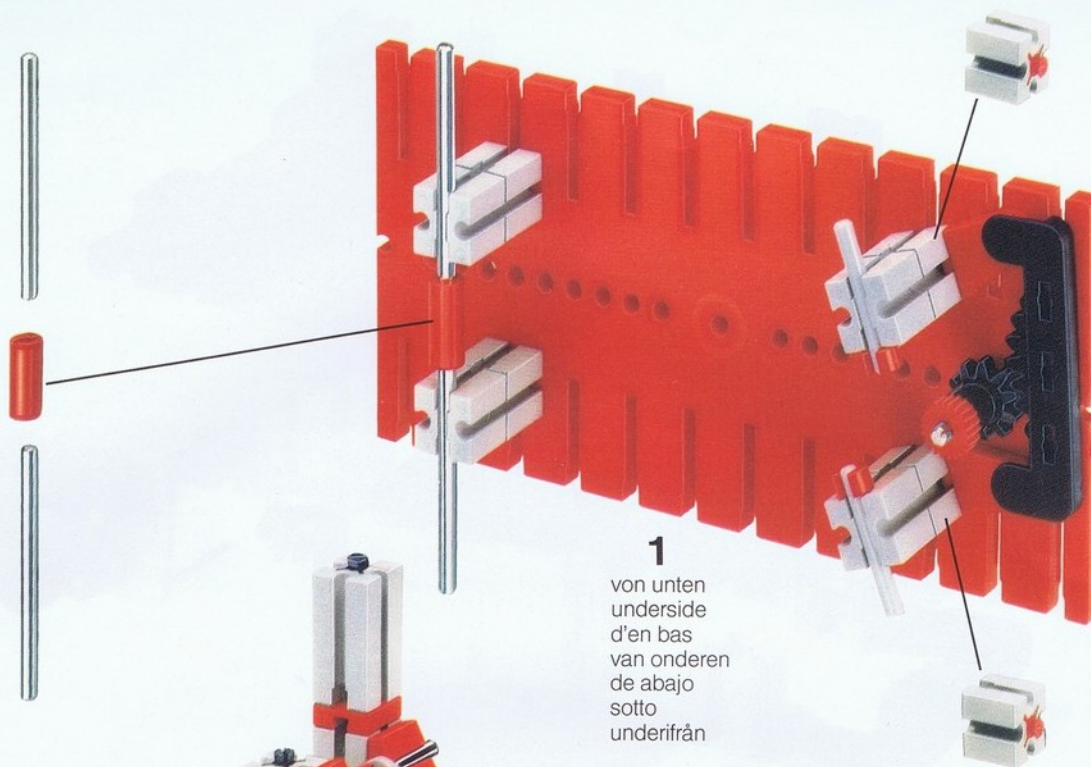

1
 von unten
 underside
 d'en bas
 van onderen
 de abajo
 sotto
 underifrån

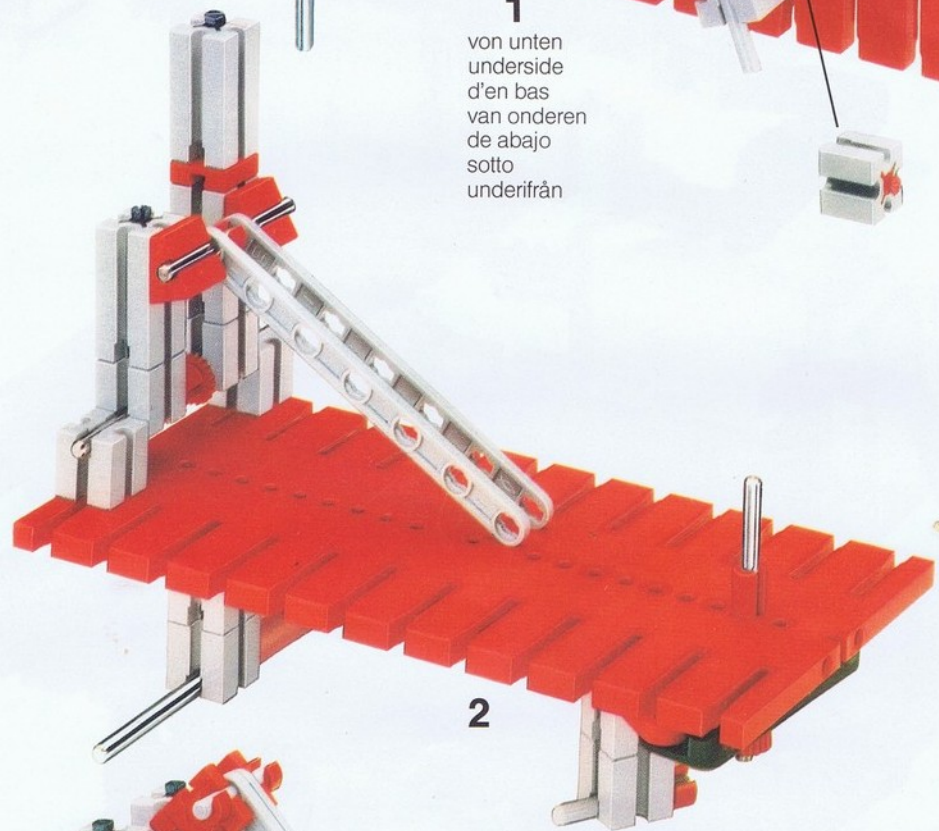

2

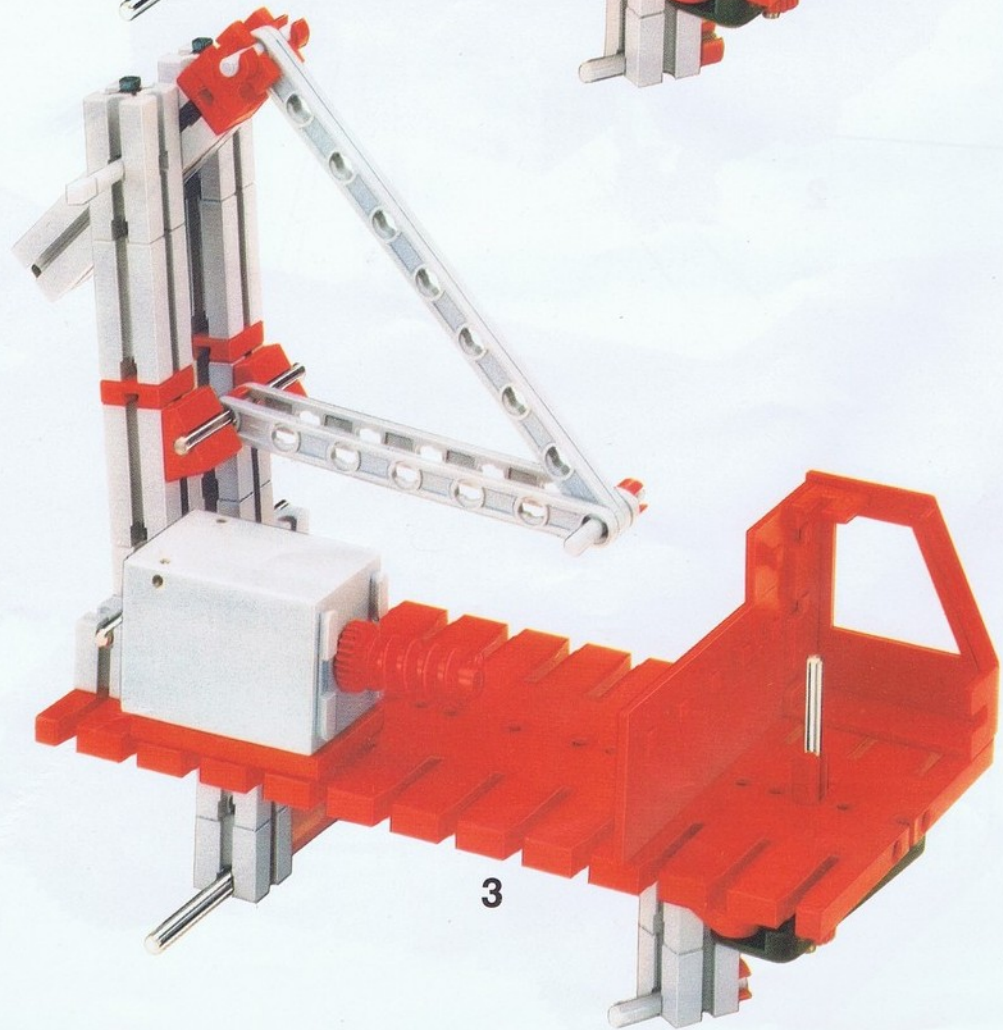

3



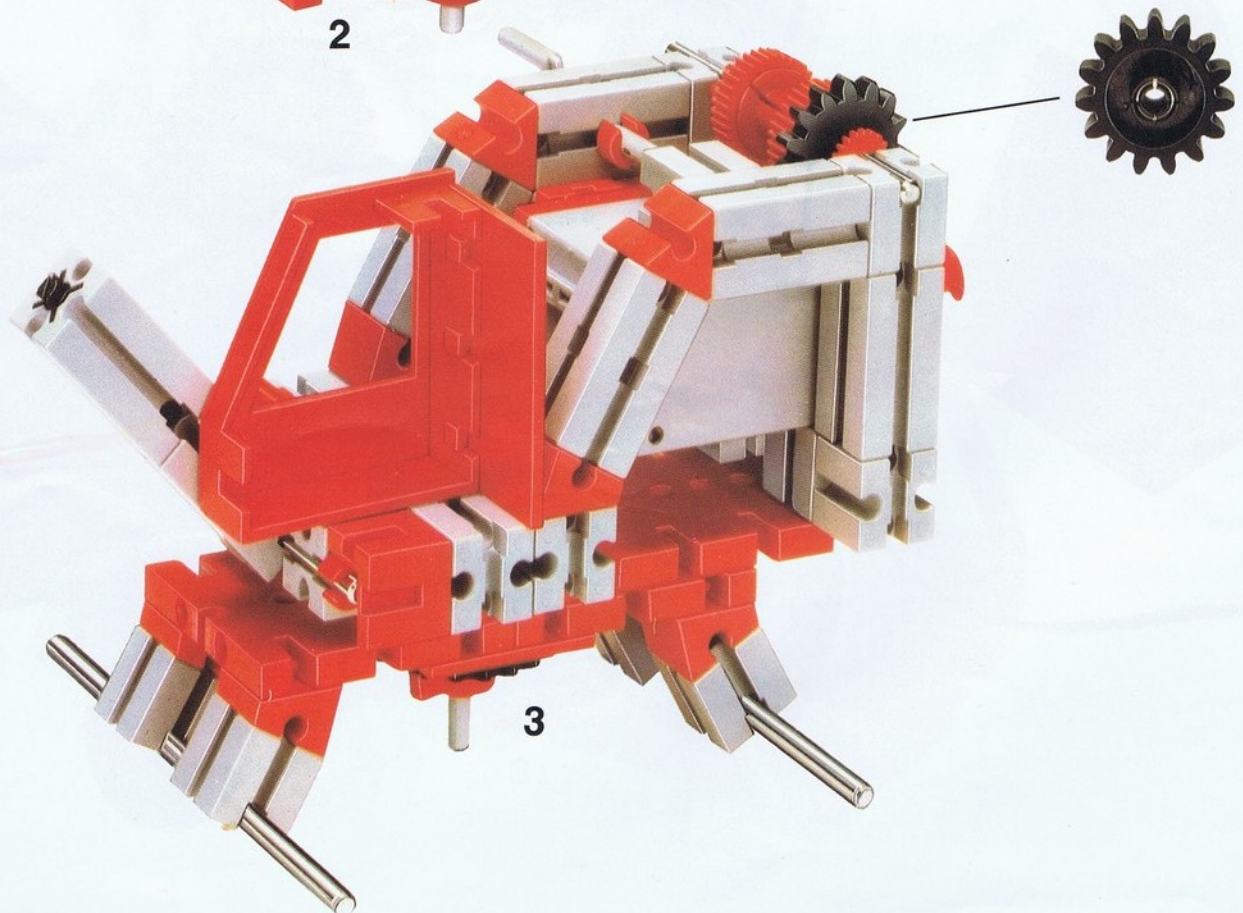
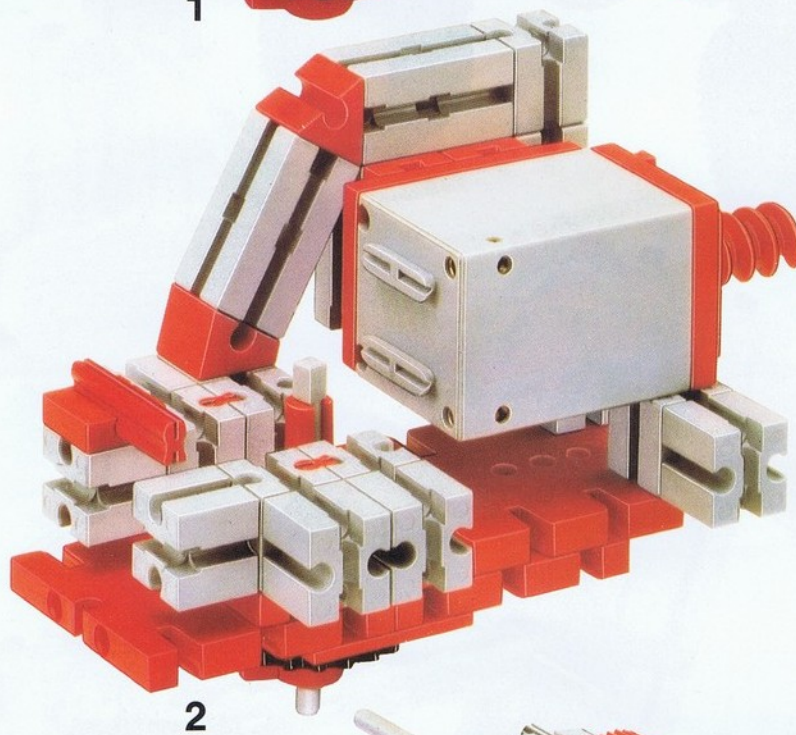
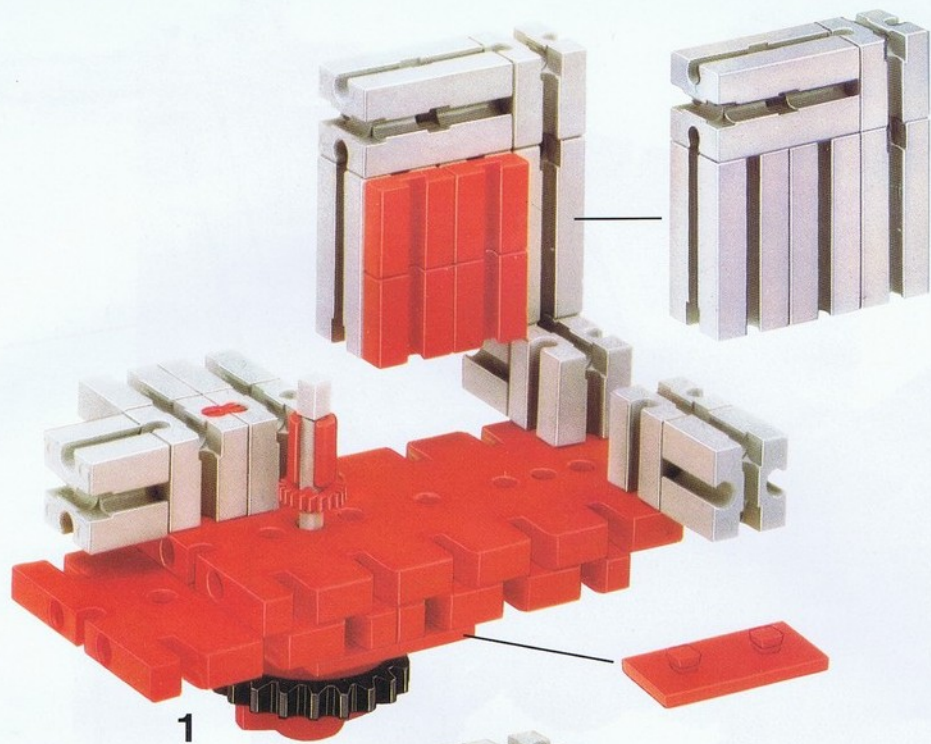



4

4

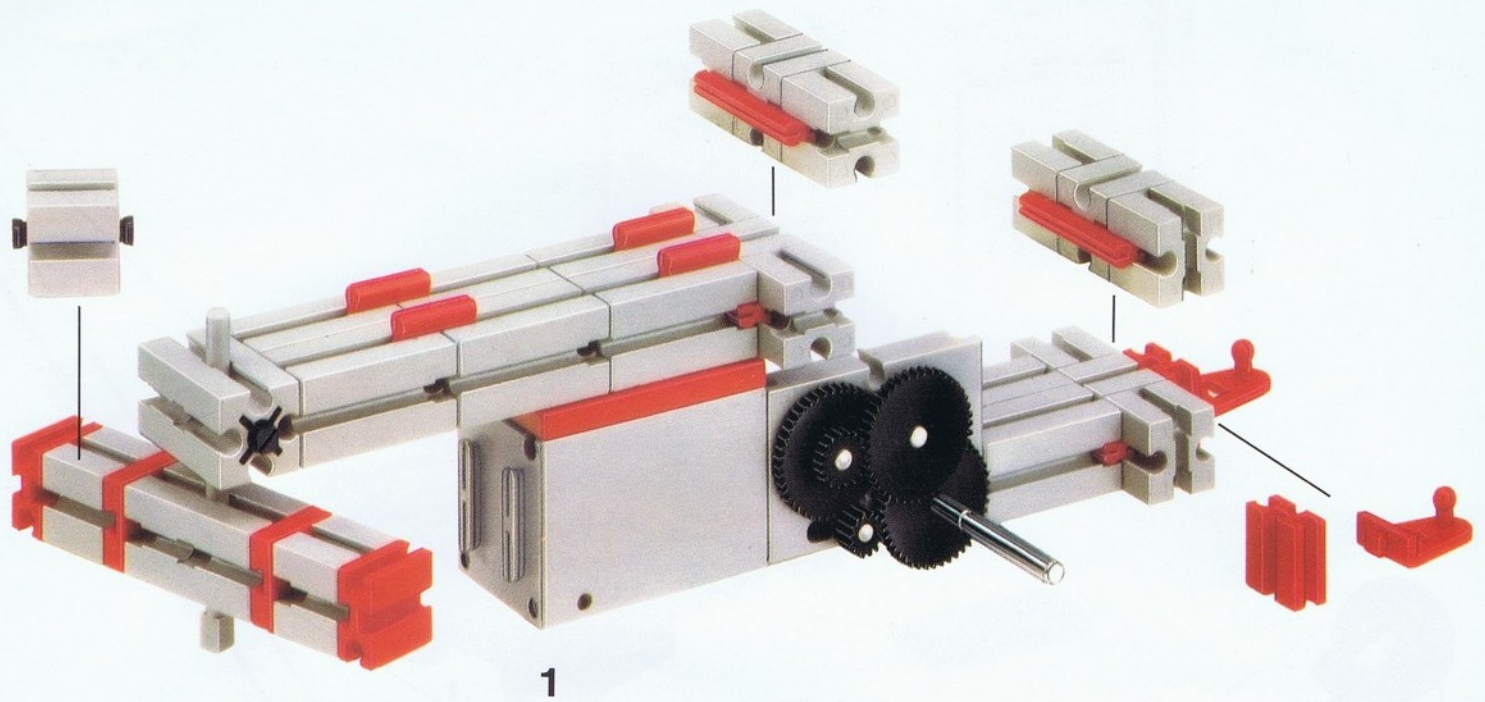

1

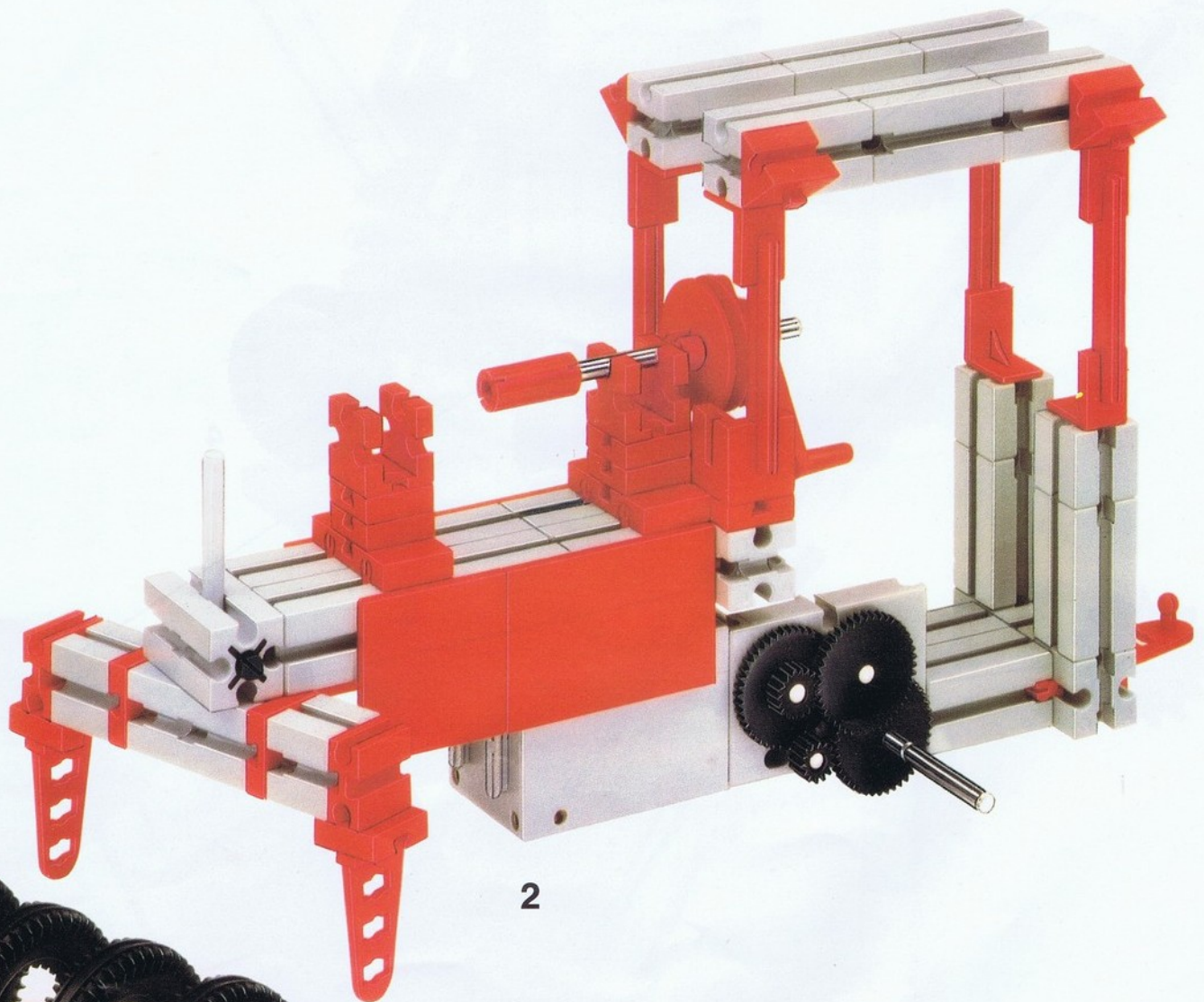

2

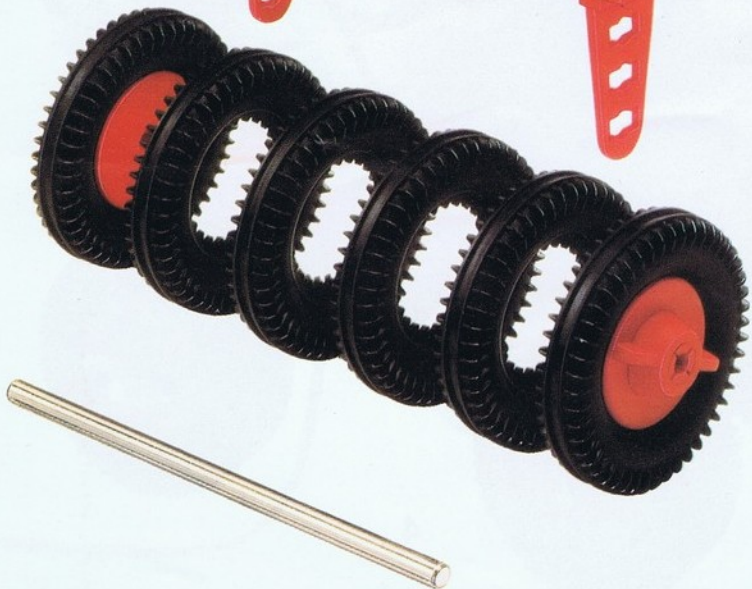

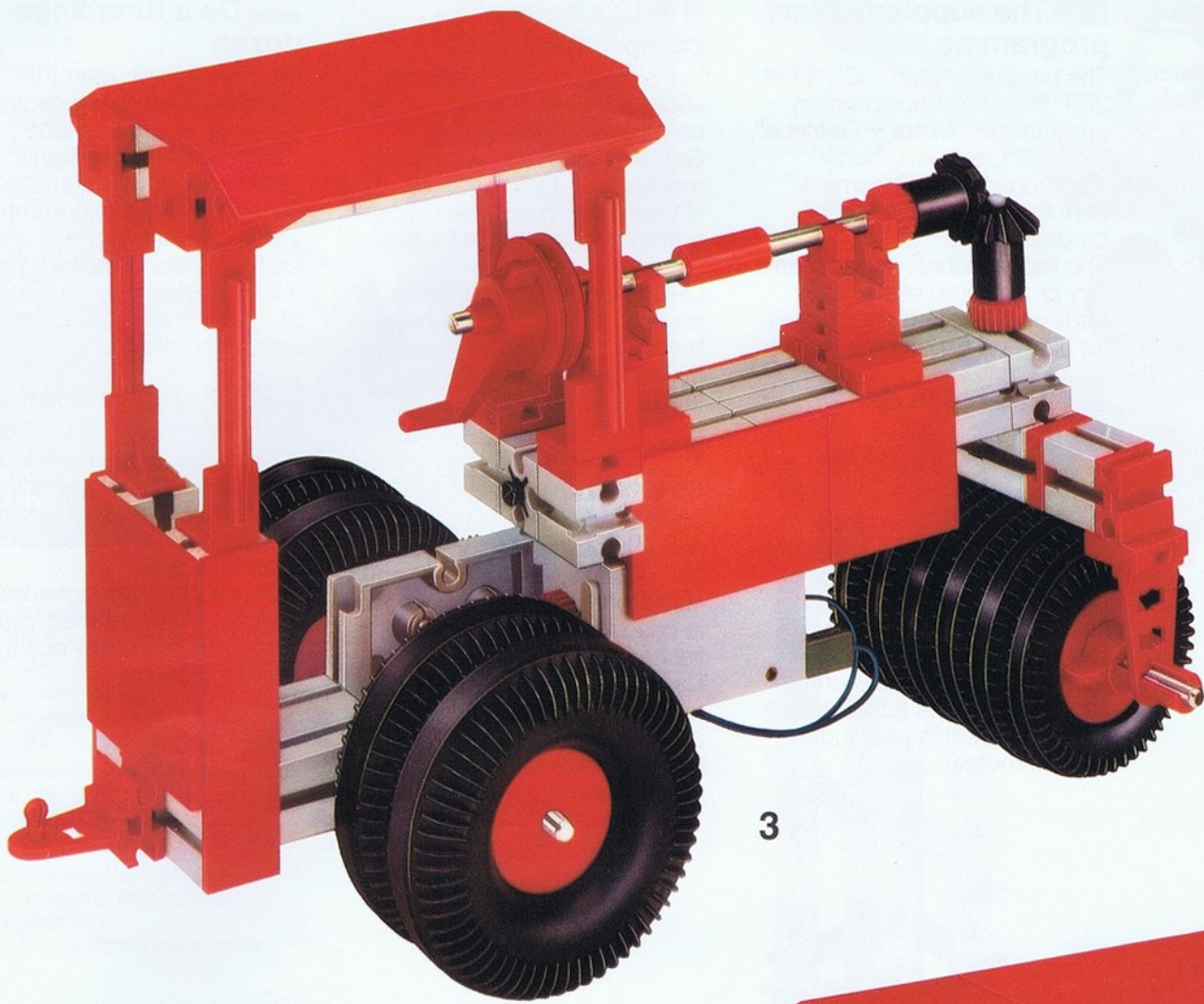

3

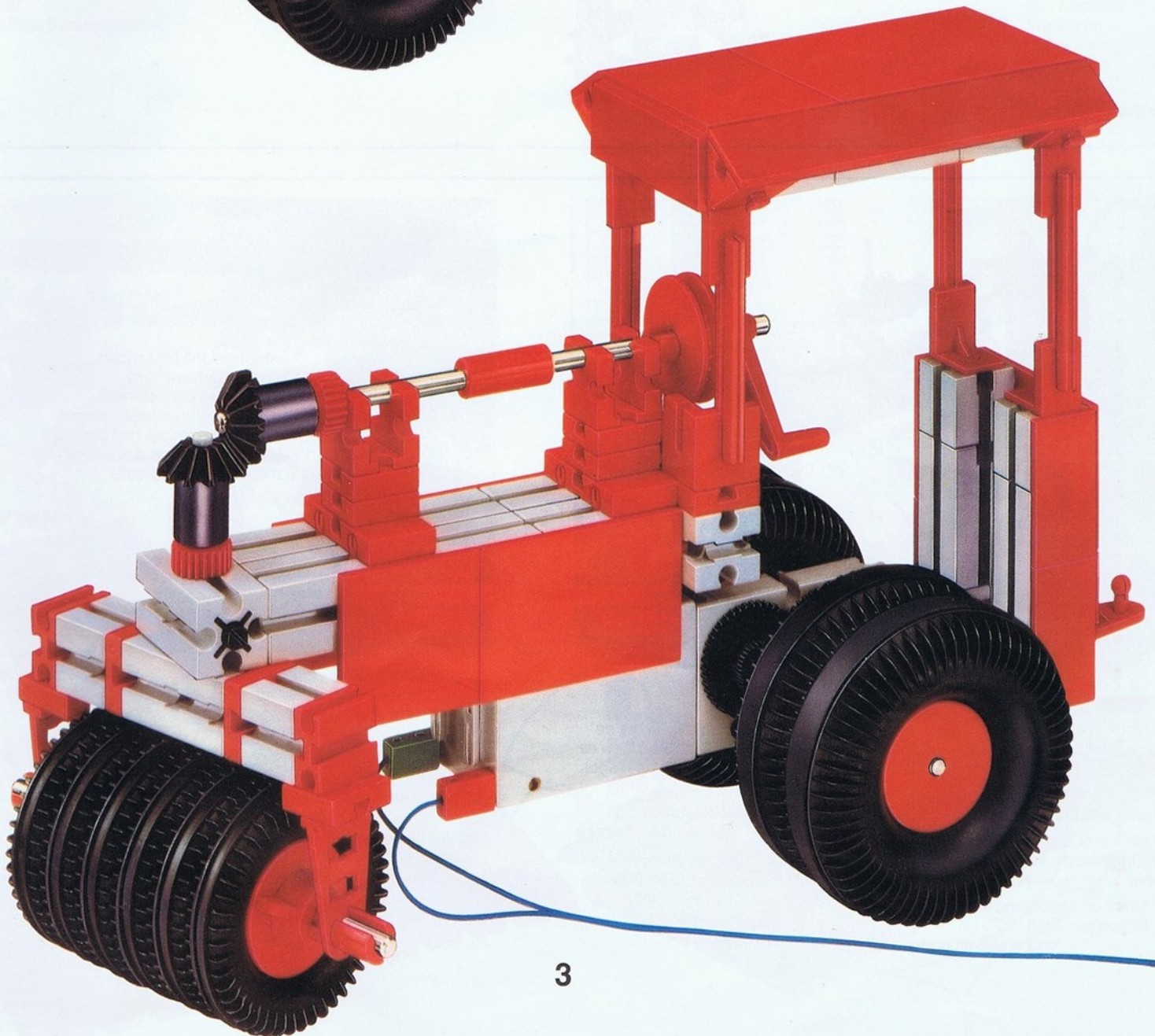

3

Die Ausbau-Kästen

Die Baukästen Start 100, Start 200 und die Ausbau-Kästen Motor + Getriebe, Statik, Elektromechanik, Elektronik und Pneumatik bilden das Kernprogramm von fischertechnik. Die fischertechnik Ausbau-Kästen bieten viele zusätzliche spannende Spiel- und Experimentiermöglichkeiten.

The supplementary programme

The basic kits "Start 100", "Start 200" plus the supplementary programme: "Motor + Getriebe", "Statik", "Elektromechanik", "Elektronik" and "Pneumatik", from the main fischertechnik programme.

The fischertechnik supplementary programme offers many additional, exciting possibilities for play and experiment.

Las cajas de ampliación

Las cajas «Start 100», «Start 200» y las cajas de ampliación «Motor + Getriebe», «Statik», «Elektromechanik», «Elektronik» y «Pneumatik» representan el programa esencial de fischertechnik.

Las cajas de ampliación de fischertechnik ofrecen numerosas posibilidades adicionales y muy interesantes para jugar y experimentar.

Les boîtes complémentaires

Les boîtes de base «Start 100», «Start 200» ainsi que les boîtes complémentaires «Motor + Getriebe», «Statik», «Elektromechanik», «Elektronik» et «Pneumatik» constituent le programme fondamental fischertechnik.

Les boîtes complémentaires fischertechnik offrent de nombreuses possibilités supplémentaires de jeu et d'expérimentation.

Cassette di ampliamento

Lo «Start 100» e lo «Start 200» con le cassette «Motor + Getriebe», «Statik», «Elektromechanik», «Elektronik», «Pneumatik» sono la base centrale del programma fischertechnik.

L'aggiunta delle cassette di ampliamento fischertechnik offre altre avvincenti possibilità di gioco e di interessanti esperimenti.

De uitbreidingsdozen

De bouwdozen „Start 100“, „Start 200“ en de uitbreidingsdozen „Motor + Getriebe“, „Statik“, „Elektromechanik“, „Elektronik“ en „Pneumatik“ vormen het basisprogramma van fischertechnik.

De fischertechnik uitbreidingsdozen bieden vele extra mogelijkheden om te spelen en te experimenteren.

Utbyggnadslådorna

Bygglådan »Start 100«, »Start 200« och utbyggnadslådorna »Motor + Getriebe«, »Statik«, »Elektromechanik«, »Elektronik« och »Pneumatik« är baslådorna i fischertechnik. fischertechnik utbyggnadslådor erbjuder mängder med ytterligare spännande lek- och experimentmöjligheter.





 Motor und viele Getriebe-Elemente. Voraussetzung Start 100. Ab 6 Jahre.

 Motor and gear parts. Prerequisite: "Start 100". From 6 years.

 Moteur et nombreux éléments d'engrenage. «Start 100» indispensable. A partir de 6 ans.

 Motor en aandrijving elementen. Benodigd: „Start 100“. Voor 6 jaar en ouder.

 Motor y muchos elementos de engranaje. La caja «Start 100» es indispensable. A partir de 6 años.

 Motore e molti ingranaggi. È necessario «Start 100». Da 6 anni in poi.

 Motor och många utväxlingsdelar. Förutsättning »Start 100«. Från 6 år.

Förderband mit Lastwagen
Conveyor belt and lorry
Tapis rowlant avec camion
Transportband met vrachtwagen
Cinta transportadora con camión
Nastro trasportatore con camion
Transportband med lastbil

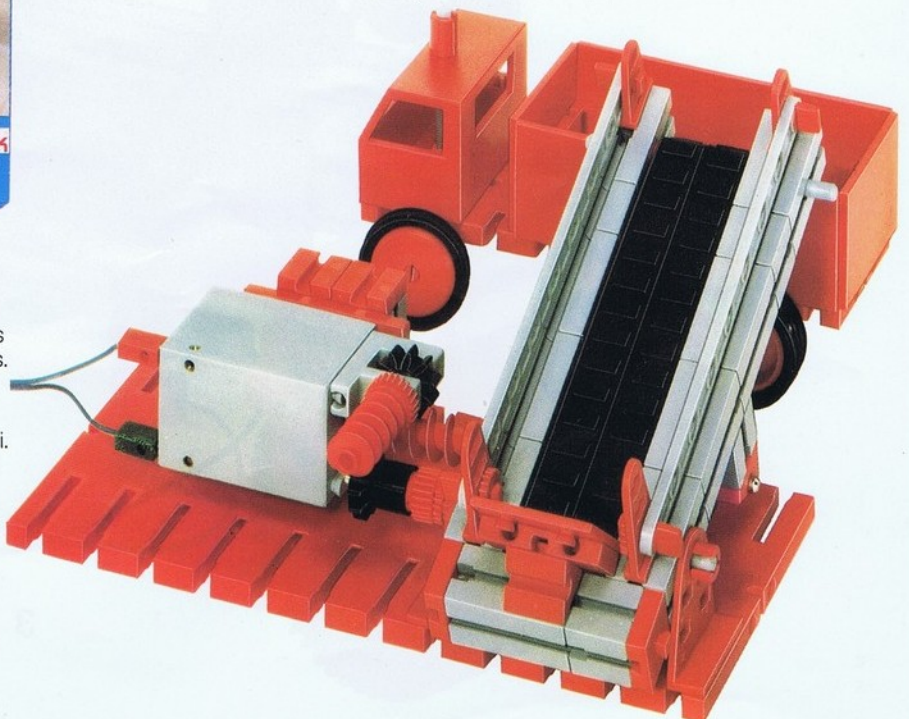



Statik-Elemente für große Kräne, Türme, Karusselle. Voraussetzung Start 100. Ab 6 Jahre.

Static parts for large cranes, towers, roundabouts. Prerequisite: "Start 100". From 6 years.

Eléments de superstructures pour des grandes grues, tours, manèges. «Start 100» indispensable. A partir de 6 ans.

Statika elementen voor grote kranen, torens, draaimolens. Benodigd: „Start 100“. Voor 6 jaar en ouder.

Elementos estáticos para grandes grúas, torres, carruseles. Caja indispensable «Start 100». A partir de 6 años.

Elementi di statica per grandi gru, torri e giostre. È necessario «Start 100». Da 6 anni in poi.

Statik-delar för stora kranar, torn, broar, karuseller. Förutsättning »Start 100«. Från 6 år.



Portalkran
Portal crane
Grue à portique
Portaalkraan
Grúa de pórtico
Gru pontone
Portalkran

Start 100 · Statik



Elektromechanik-Elemente zum Schalten und Steuern. Voraussetzung Start 100, empfohlen Motor + Getriebe und Netzgerät mot 4. Ab 10 Jahre.

Electromechanical parts for switching and steering. Prerequisite: "Start 100", recommended: "Motor + Getriebe" and transformer "mot 4". From 10 years.

Eléments d'électromécanique pour commande et régulation. «Start 100» indispensable, «Motor + Getriebe» et boîtier d'alimentation «mot 4» recommandés. A partir de 10 ans.

Elektromechanika elementen voor het schakelen en besturen. Benodigd: „Start 100“. Aanbevolen wordt „Motor + Getriebe“ en transformator „mot 4“. Voor 10 jaar en ouder.

Elementos electromecánicos para conexión y Dirección. Caja indispensable «Start 100», cajas recomendadas «Motor + Getriebe» y equipo de alimentación «mot 4». A partir de 10 años.

Elementi di elettromeccanica per commutare e comandare le costruzioni. È necessario «Start 100», consigliato «Motor + Getriebe» e trasformatore «mot 4». Da 10 anni in poi.

Elektromekanik-komponenter för att styra och reglera. Förutsättning »Start 100«. Kan lämpligen byggas ut med »Motor + Getriebe» och Transformator »mot 4«. Från 10 år.



Blinkanlage
Signal equipment
Installation clignotante
Knipperlicht
Emisor de señales luminosas
Lampeggiatore
Blinkanläggning

Start 100 · Motor + Getriebe · Elektromechanik



Elektronik-Elemente zum Steuern und Regeln. Voraussetzung Start 100, empfohlen Motor + Getriebe, Elektromechanik und Netzgerät mot 4. Ab 12 Jahre.

Electronic parts for steering and controlling. Prerequisite: "Start 100", recommended: "Motor + Getriebe", "Elektromechanik" and transformer "mot 4". From 12 years.

Éléments d'électronique pour commande et réglage. «Start 100» indispensable, «Motor + Getriebe», «Elektromechanik» et boîtier d'alimentation «mot 4» recommandés. A partir de 12 ans.

Elektronika elementen voor het besturen en regelen. Benodigd: „Start 100“. Aanbevolen wordt „Motor + Getriebe“, „Elektromechanik“ en transformator „mot 4“. Voor 12 jaar en ouder.

Elementos electrónicos par Dirección y Regulación. Caja indispensable «Start 100», cajas recomendadas «Motor + Getriebe», «Elektromechanik» y equipo de alimentación «mot 4». A partir de 12 años.

Elementi di elettronica per comandare e regolare. È necessario «Start 100», consigliato «Motor + Getriebe», «Elektromechanik» e trasformatore «mot 4». Da 12 anni in poi.

Elektronik-komponenter för att styra och reglera. Förutsättning »Start 100». Kan lämpligen byggas ut med »Motor + Getriebe», »Elektromechanik» och Transformator »mot 4». Från 12 år.



Elektronischer Morsetaster
Electronic morse key
Manipulateur Morse électronique
Elektronische morsetaster
Manipulador Morse electrónico
Tasto morse elettronico
Elektronisk morseapparat

Start 100 · Elektronik



Pneumatik-Elemente der Antriebs- und Steuerungstechnik. Voraussetzung Start 100, empfohlen geeignete Druckluftquelle. Ab 12 Jahre.

Pneumatic parts for power and steering techniques. Prerequisite: "Start 100", recommended: compressed air source. From 12 years.

Éléments de pneumatique pour technique d'entraînement et de commande. «Start 100» indispensable, source d'air comprimé recommandée. A partir de 12 ans.

Pneumatika elementen van aandrijvings- en besturingstechniek. Benodigd: „Start 100“. Aanbevolen wordt beschikbaarheid van samengeperste lucht. Voor 12 jaar en ouder.

Elementos neumáticos de técnico accionamiento y dirección. Caja indispensable «Start 100», recomendado un equipo de aire comprimido. A partir de 12 años.

Elementi di pneumatica per dare movimento alle costruzioni. È necessario «Start 100» e fonte di aria compressa (compressore). Da 12 anni in poi.

Pneumatik-delar för drivnings- och styrningsteknik. Förutsättning »Start 100». Rekommenderas tryckluft. Från 12 år.

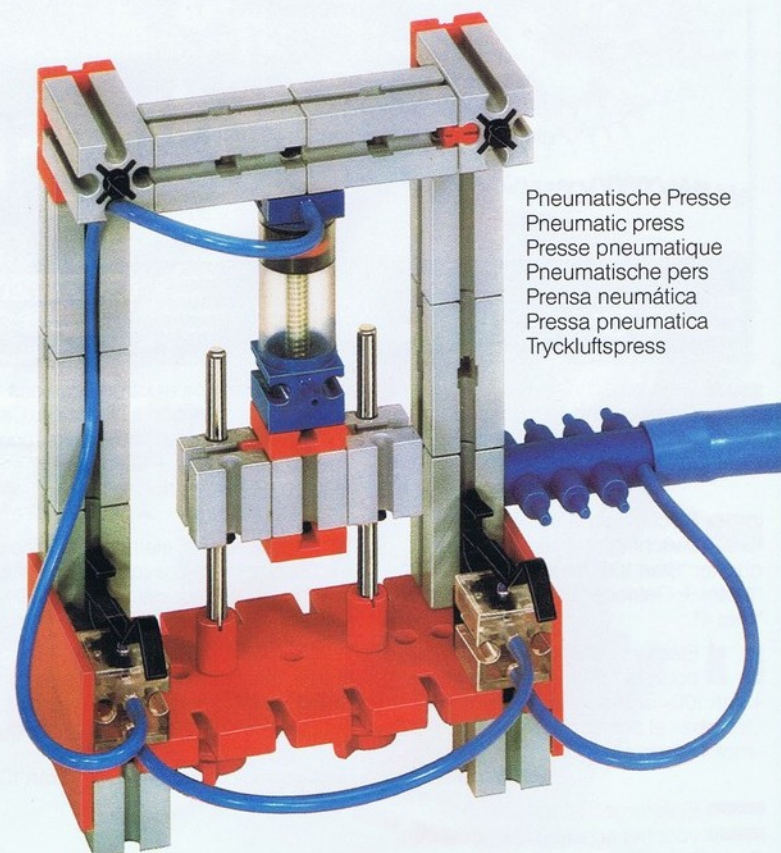

Pneumatische Presse
Pneumatic press
Presse pneumatique
Pneumatische pers
Prensa neumática
Tryckluftspres

Start 100 · Pneumatik

 Zusatz-Programm

 Additional programme

 Programme complémentaire

 Aanvullings programma

 Programa adicional

 Programma addizionale

 Tillägsprogram

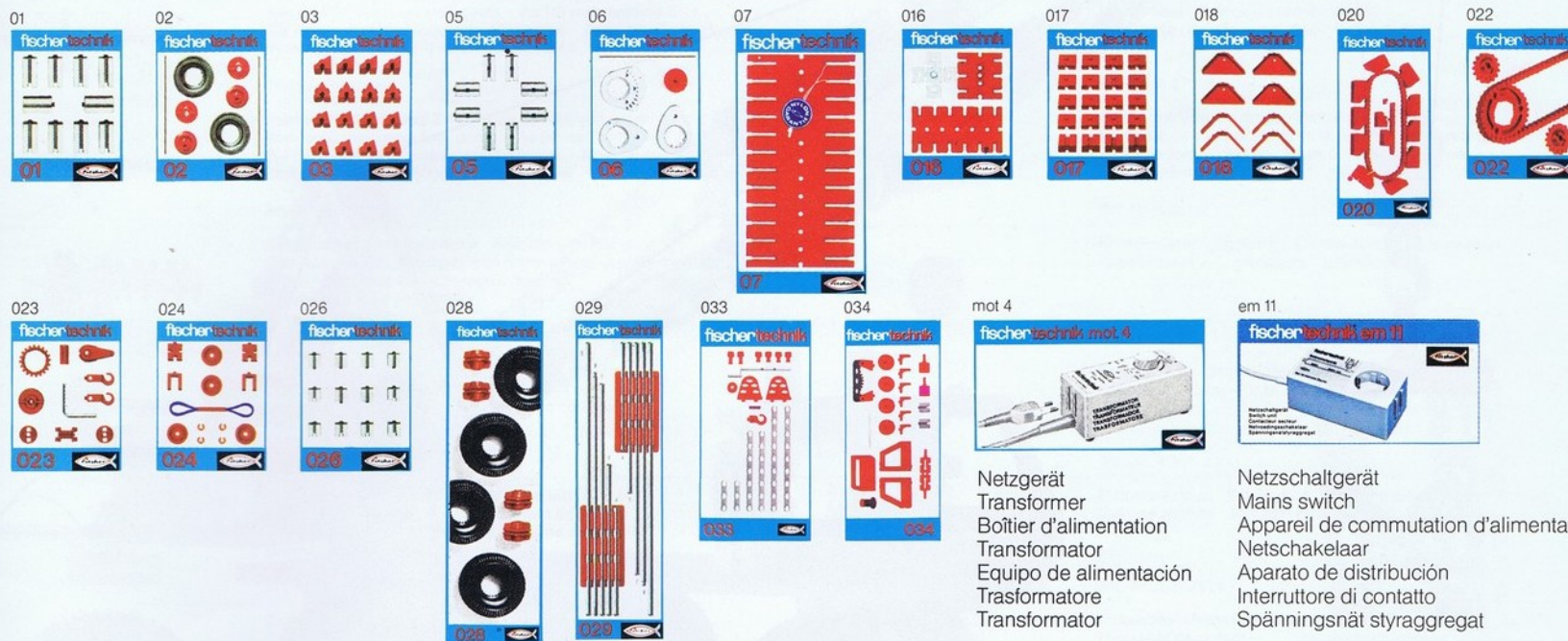

Karussell
Chairoplane
Manège
Draaimolen
Carrusel
Giostra
Karussell

Start 100 · Motor+Getriebe · Statik

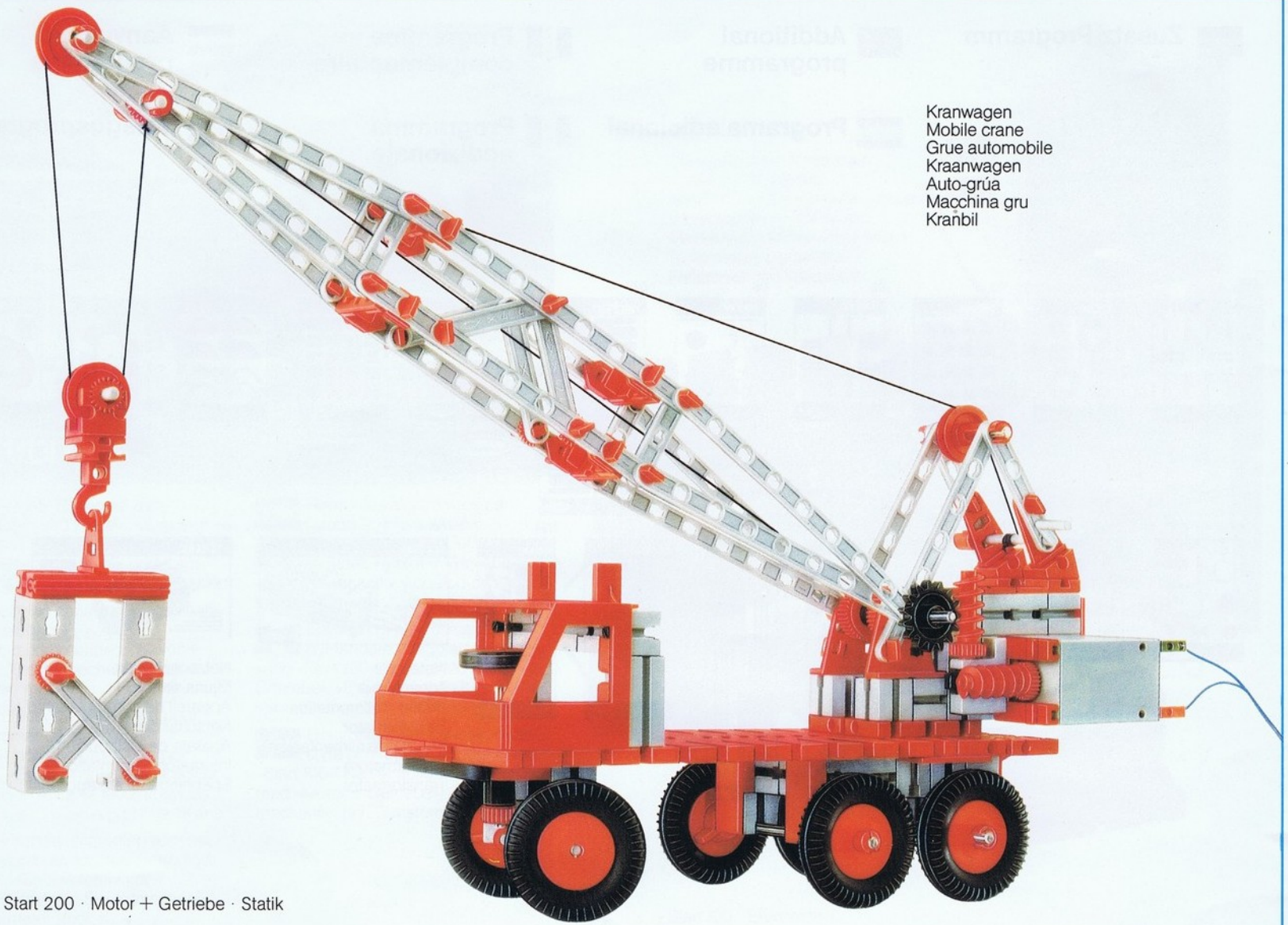





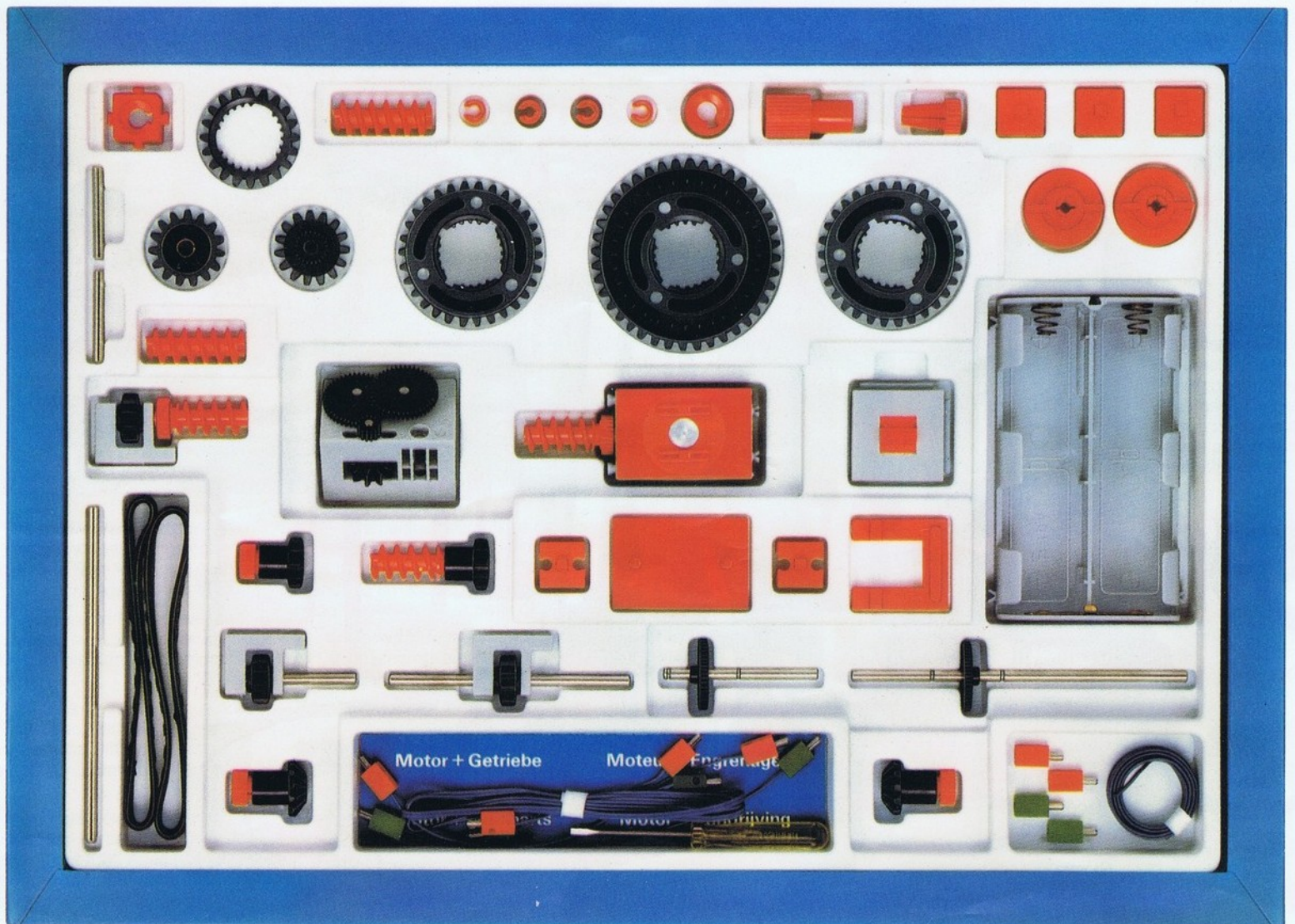











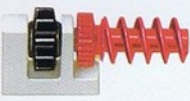



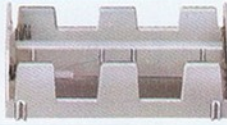











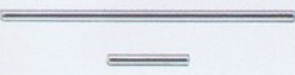

Kranwagen
 Mobile crane
 Grue automobile
 Kraanwagen
 Auto-grúa
 Macchina gru
 Kranbil

Start 200 · Motor + Getriebe · Statik



Stückliste · Part List · Nomenclature · Onderdelenlijst · Lista de piezas · Lista dei pezzi · Detalj översikt

	Motor 6V- · Motor 6V- · Moteur courant continue 6V- · Motor 6V- · Motor de 6V.c.c. · Motore 6V- · Motor 6V-		Klemmbare Schnecke mit Ritzel Z10 · Worm and pinion Z10 · Vis sans fin avec pignon à 10 dents · Worm met rondsel Z10 die kan worden vastgeklemd · Tornillo sin fin bloqueable con piñón Z10 · Vite senza fine bloccabile con pignone Z10 · Klämsnäckskruv med drev Z10 Art.-Nr. 3 35810 1
	Stufengetriebe · Reduction gearbox · Réducteur de vitesse · Reductiekast · Reductor de velocidad · Ingranaggio progressivo · Reduktionsväxel Art.-Nr. 3 31048 1		Schneckenenteil · Worm · Élément de vis sans fin · Wormdeel · Pieza de tornillo sin fin · Elemento vite senza fine · Snäckdel Art.-Nr. 4 37926 1
	Achse 110 mit Zahnrad Z44 · Axle 110 with gearwheel Z44 · Axe de 110 avec roue à 44 dents · As 110 met tandwiel Z44 · Eje 110 con rueda dentada de 44 dientes · Asse 110 con ruota dentata Z44 · Axel 110 med kuggjul Z44 Art.-Nr. 3 31049 1		Schneckenmutter · Wormnut · Ecrou de vis sans fin · Wormmoer · Tuerca de tornillo sin fin · Madre vite per vite senza fine · Snäckmutter Art.-Nr. 4 37925 1
	Achse 50 mit Zahnrad Z44 · Axle 50 with gearwheel Z44 · Axe de 50 avec roue à 44 dents · As 50 met tandwiel Z44 · Eje 50 con rueda dentada de 44 dientes · Asse 50 con ruota dentata Z44 · Axel 50 med kuggjul Z44 Art.-Nr. 3 31050 1		Schnecken-Spannzange · Worm grip · Ecrou de serrage pour vis sans fin · Worm-spantang · Pinza de tornillo sin fin · Pinza per vite senza fine · Snäck-spännskruv Art.-Nr. 4 31717 1
	Getriebebock mit Schnecke · Bracket with worm · Réducteur à vis · Asdrager met worm · Reductor de tornillo sin fin · Supporto con vite senza fine · Drevhållare med snäckdrev Art.-Nr. 3 31045 1		Kontermutter · Locknut · Contre-écrou · Contra-moer · Contratuercas · Controdado · Låsmutter Art.-Nr. 4 31711 1
	Getriebebock ohne Schnecke · Bracket without worm · Réducteur · Asdrager zonder worm · Reductor sin tornillo sin fin · Supporto con asse · Drevhållare Art.-Nr. 3 31046 1		Spannzange · Grip · Ecrou de serrage · Spantang · Pinza · Pinza di serraggio · Spännskruv Art.-Nr. 4 35113 1
	Getriebehälter mit Welle 80 · Bracket with axle 80 · Réducteur à axe de 80 · Asdrager met as 80 · Porta-reductor con árbol 80 · Riduzione all'asse 80 · Drevhållare med axel 80 Art.-Nr. 3 38201 1		Batteriekasten · Batterybox · Boîtier à piles · Batteryholder · Caja de batería · Armadio batterie · Batterilåda Art.-Nr. 3 37261 1
	Zahnrad Z40/32 · Gearwheel Z40/32 · Couronne à Z40/32 · Tandwiel Z40/32 · Rueda dentada Z40/32 · Ruota dentata Z40/32 · Kuggjul Z40/32 Art.-Nr. 4 31022 1		Polwendesalter · Polarity changeover switch · Inverseur de polarité · Poolomkeerschakelaar · Interruptor de inversion de polos · Commutatore di polarità · Polvändarkontakt Art.-Nr. 3 36707 1
	Zahnrad Z30 · Gearwheel Z30 · Couronne à Z30 · Tandwiel Z30 · Rueda dentada Z30 · Ruota dentata Z30 · Kuggjul Z30 Art.-Nr. 4 36264 1		Kabel 1-adrig 150 mm mit Stecker, grün · 1-core cable 150 mm with green plug · Câble unifilaire à fiche verte, 150 mm · 1-aderige kabel 150 mm met stekker, groen · Cable monopolar de 150 mm con enchufe, verde · Cavo monoconduttore 150 mm con spina, verde · Kabel (1-ledare) 150 mm med kontakt, grön Art.-Nr. 3 37162 1
	Zahnrad Z20 · Gearwheel Z20 · Couronne à Z20 · Tandwiel Z20 · Rueda dentada Z20 · Ruota dentata Z20 · Kuggjul Z20 Art.-Nr. 4 31021 1		Kabel 1-adrig 150 mm mit Stecker, rot · 1-core cable 150 mm with red plug · Câble unifilaire à fiche rouge, 150 mm · 1-aderige kabel 150 mm met stekker, rood · Cable monopolar de 150 mm con enchufe, rojo · Cavo monoconduttore 150 mm con spina, rosso · Kabel (1-ledare) 150 mm med kontakt, röd Art.-Nr. 3 37163 1
	Zahnrad Z15 · Gearwheel Z15 · Couronne à Z15 · Tandwiel Z15 · Rueda dentada Z15 · Ruota dentata Z15 · Kuggjul Z15 Art.-Nr. 4 35695 1		Kabel 2-adrig 1000 mm mit Stecker · 2-core cable 1000 mm with plug · Câble bifilaire à fiche, 1000 mm · 2-aderige kabel 1000 mm met stekker · Cable bipolar de 1000 mm con enchufe · Cavo a due fili 1000 mm con spina · Kabel (2-ledare) 1000 mm med kontakt Art.-Nr. 3 37170 1
	Klemmzahnrad Z15 · Idler gear Z15 · Rouleau compresseur Z15 · Klemtandwiel Z15 · Rueda dentada de apriete Z15 · Ruota dentata bloccante Z15 · Kläm-kuggjul Z15 Art.-Nr. 3 37685 1		Litze 2-adrig 1000 mm · 2-core flex 1000 mm · Câble bifilaire, 1000 mm · 2-aderig draadje 1000 mm · Cordón bipolar 1000 mm · Cavetto a due fili, 1000 mm · Kabel (2-ledare) 1000 mm Art.-Nr. 4 36382 5
	Ritzel Z10 mit Spannzange · Cog wheel Z10 with collet · Pignon Z10 avec écrou de serrage · Rondsel Z10 met spantang · Piñón Z10 con pinza de apriete · Pignone Z10 con pinza · Drev med klämtång Art.-Nr. 3 31047 1		Flachstecker, grün · flat plug, green · Fiche plate, verte · Platte stecker, groen · Enchufe plano, verde · Spina piatta, verde · Kontakt grön – Art.-Nr. 3 31336 1 Flachstecker, rot · Flat plug, red · Fiche plate, rouge · Platte stecker, rood · Enchufe plano, rojo · Spina piatta, rosso · Kontakt, röd – Art.-Nr. 3 31337 1
	Kegelzahnrad · Bevel gear wheel · Roue coniques · Kegelrandwiel · Rueda dentada · Ruota dentata conica · Konisk kuggjul Art.-Nr. 3 31051 1		Schraubendreher · Screwdriver · Tournevis · Schroevendraaier · Destornillador · Cacciavite · Skruvmejsel Art.-Nr. 4 36443 7
	Flachnabe · Fiat hub · Moyeu plat · Platte naaf · Cubo plano · Mozzo piatto · Plattnav Art.-Nr. 3 31015 1		Adapter · Adaptor · Adapteur · Adapter · Adaptor · Adattatore · Adapter Art.-Nr. 4 38203 1
	Achse 110 · Axle 110 · Axe 110 · As 110 · Eje 110 · Asse 110 · Axel 110 Art.-Nr. 4 31031 3 Achse 30 · Axle 30 · Axe 30 · As 30 · Eje 30 · Asse 30 · Axel 30 Art.-Nr. 4 31034 3		Motorsteckplatte · Push-on plate for motor · Plaque de moteur à bornes · Motorsteekplaat · Placa enchufable del motor · Piastra per innesto motore · Motor fästplatta Art.-Nr. 4 31710 1
	Rollenlager · Roller bearing · Support de poulie · Rollager · Soporte de polea · Supporto per puleggia · Rullager Art.-Nr. 4 37636 1		Raupenband · Caterpillartrack · Chenille · Rupsband · Cinta de oruga · Cingolo · Larvband Art.-Nr. 4 31057 1
	Baustein 5 · Building block 5 · Pierre rouge de 5 · Bouwsteen 5 · Bloque constructivo 5 · Modulo 5 · Byggnadssten 5 Art.-Nr. 4 37237 1		Klemmbuchse 5 · Spring clip 5 · Bague de serrage 5 · Klembus 5 · Anillo de apriete 5 · Bussola di serraggio 5 · Klämbussning 5 – Art.-Nr. 3 37679 1 Klemmbuchse 10 · Spring clip 10 · Bague de serrage 10 · Klembus 10 · Anillo de apriete 10 · Bussola di serraggio 10 · Klämbussning 10 – Art.-Nr. 3 31023 1

 **fischertechnik-
Bau-Spiel-Bahn**

Güterzug und Personenzug in zwei großen Startpackungen. Komplett mit Schienen und fischertechnik-mini-Motor. Mit großem Zusatzprogramm. Ab 6 Jahre.

 **fischertechnik construction model railway**

Goods train and passenger train complete with rails and fischertechnik mini motor in two large starter packs. Wide choice of supplementary kits. From 6 years.

 **Ferrocarril de juego fischertechnik**

Tren de mercancías y tren correo en dos grandes paquetes iniciales. Completo con railes y mini-motor fischertechnik. Con gran programa de paquetes adicionales.

A partir de 6 años.

 **Train à assembler fischertechnik**

Train de marchandises et train de voyageurs dans deux grandes boîtes de base. Avec rails et mini-moteur fischertechnik. Vaste programme complémentaire. A partir de 6 ans.

 **Ferrovie fischertechnik da costruire**

Treno trasporto merci e treno viaggiatori in due grandi cassette di partenza. Completi di binari e di fischertechnik minimot. Con ampio programma addizionale. Da 6 anni in poi.

 **fischertechnik bouw-speel-trein**

Goederentrein en personentrein in twee grote startpakketten. Kompleet met rails en de mini-motor van fischertechnik. Met het grote aanvullingsprogramma. Voor 6 jaar en ouder.

 **fischertechnik Bygg-Lek-Tåg.**

Godståg och persontåg i två stora grundförpackningar. Komplett med skenor och fischertechnik mini-motor. Med stort tillbehörsprogram. Från 6 år.

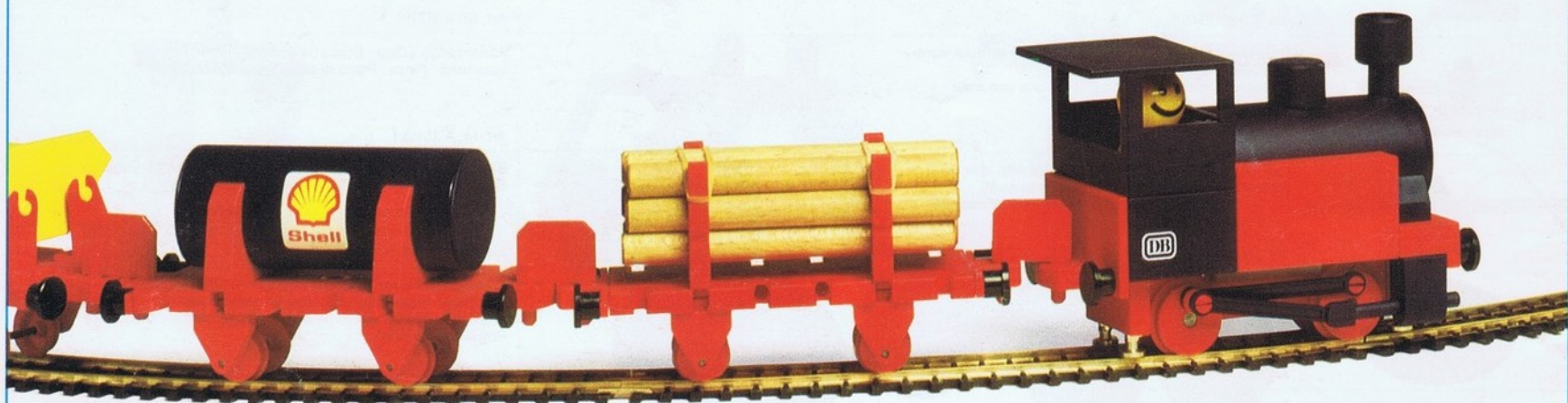

 **Drei große fischertechnik-Modell-Bausätze**

Traktor mit Anhänger, Planier-
raupe, Karussell. Alle Modelle
schnell und leicht zu bauen.
Ab 6 Jahre.

 **Three big fischertechnik model building sets**

Tractor and trailer, bulldozer, roundabout. All models can be built easily and quickly. From 6 years.

 **Tres grandes cajas para modelos fischertechnik**

Tractor con remolque, planeador-oruga, carrusel. Todos modelos pueden construirse rápido y fácilmente. A partir de 6 años.

 **Trois grandes boîtes de construction de modèles fischertechnik**

Tracteur avec remorque, niveleuse, manège. Le montage de ces modèles est rapide et facile. A partir de 6 ans.

 **Scatole contenenti i pezzi per costruire tre grandi modelli fischertechnik**

Trattore con rimorchio, ruspa, giostra. La costruzione dei modelli è rapida e semplice. Da 6 anni in poi.

 **Drie grote modelbouwdozen van fischertechnik**

Traktor met aanhangar, bulldozer, draaimolen. Alle modellen kunnen vlug en gemakkelijk in elkaar gezet worden. Voor 6 jaar en ouder.

 **Tre stora fischertechnik modellbyggsatser**

Traktor med släpvagn, schaktmaskin, karusell. Alla modellerna bygges snabbt och lätt. Från 6 år.

