

50 S/3

Aufbau-Statikkasten
extension pack
structural
boîte complémentaire
«superstructure»
cassetta statica
d'integrazione
aanbouw statikadoos



Art.-Nr. 6 39123 1

Aufbaustufen
der fischertechnik-
Statikkästen

extension packs for
fischertechnik structural
sets

possibilités d'extension
des boîtes «superstructure»
fischertechnik
fasi d'ampliamento delle
cassette fischertechnik
statica

uitbreidingsfasen van
de fischertechnik
statikadozen

▷ $100\text{ S} = 50\text{ S} + 50\text{ S}/1$
 $200\text{ S} = 50\text{ S} + 50\text{ S}/1 + 50\text{ S}/2$
 $300\text{ S} = 50\text{ S} + 50\text{ S}/1 + 50\text{ S}/2 + 50\text{ S}/3$

+ **Zusatzpackung ft 020**

+ **Accessory pack ft 020**

+ **Boîte de réassortiment ft 020**

+ **Aanvuldoosje ft 020**

fechen **technik**



020

Art.-Nr. 2 30320 5
Raupenkettens.
Förderbecher

Track chains,
conveyor
buckets

chaîne de
transmission avec
accessoires pour
véhicules chenillés,
godets

ruisbandenketting,
transportbakken

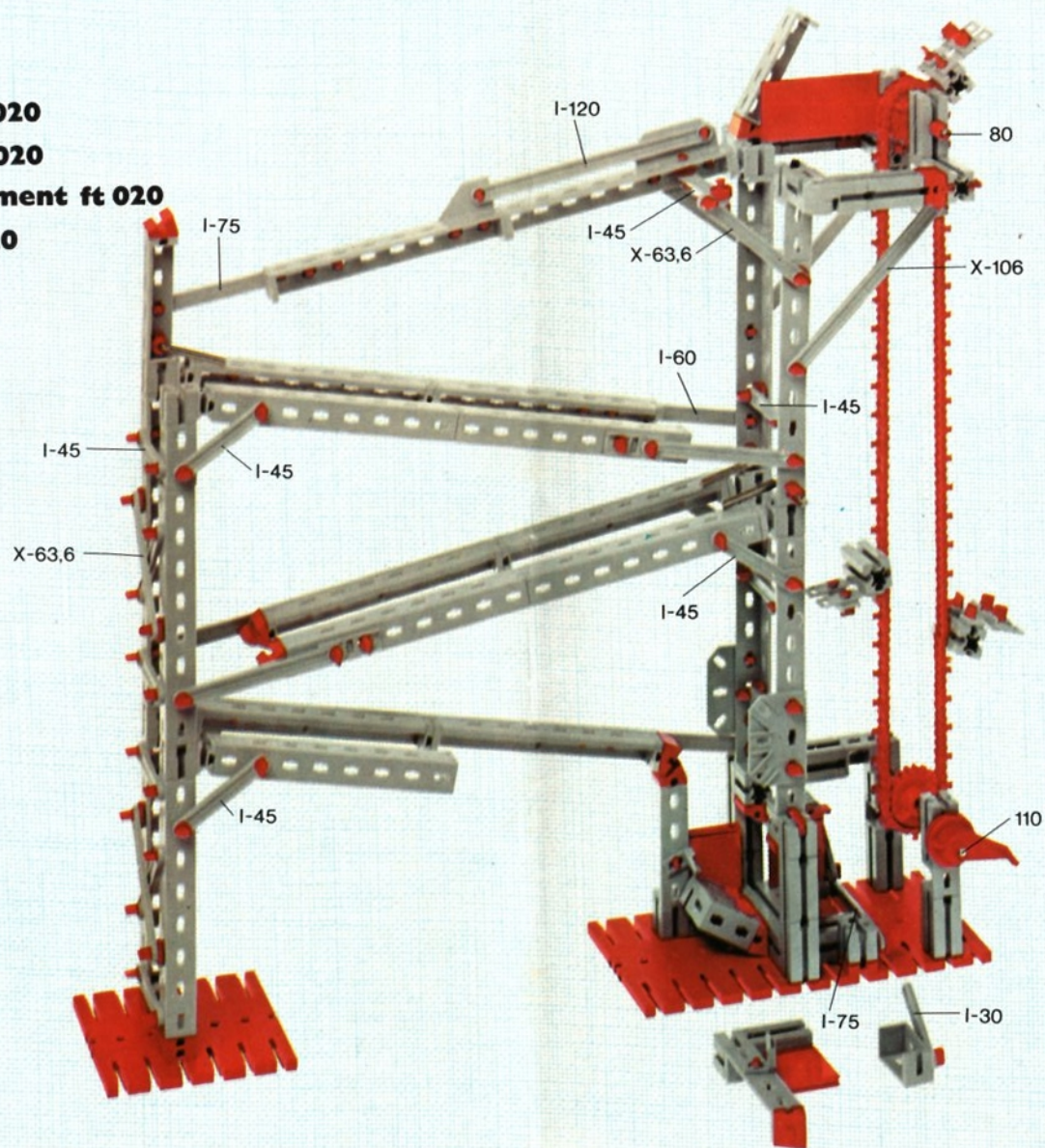

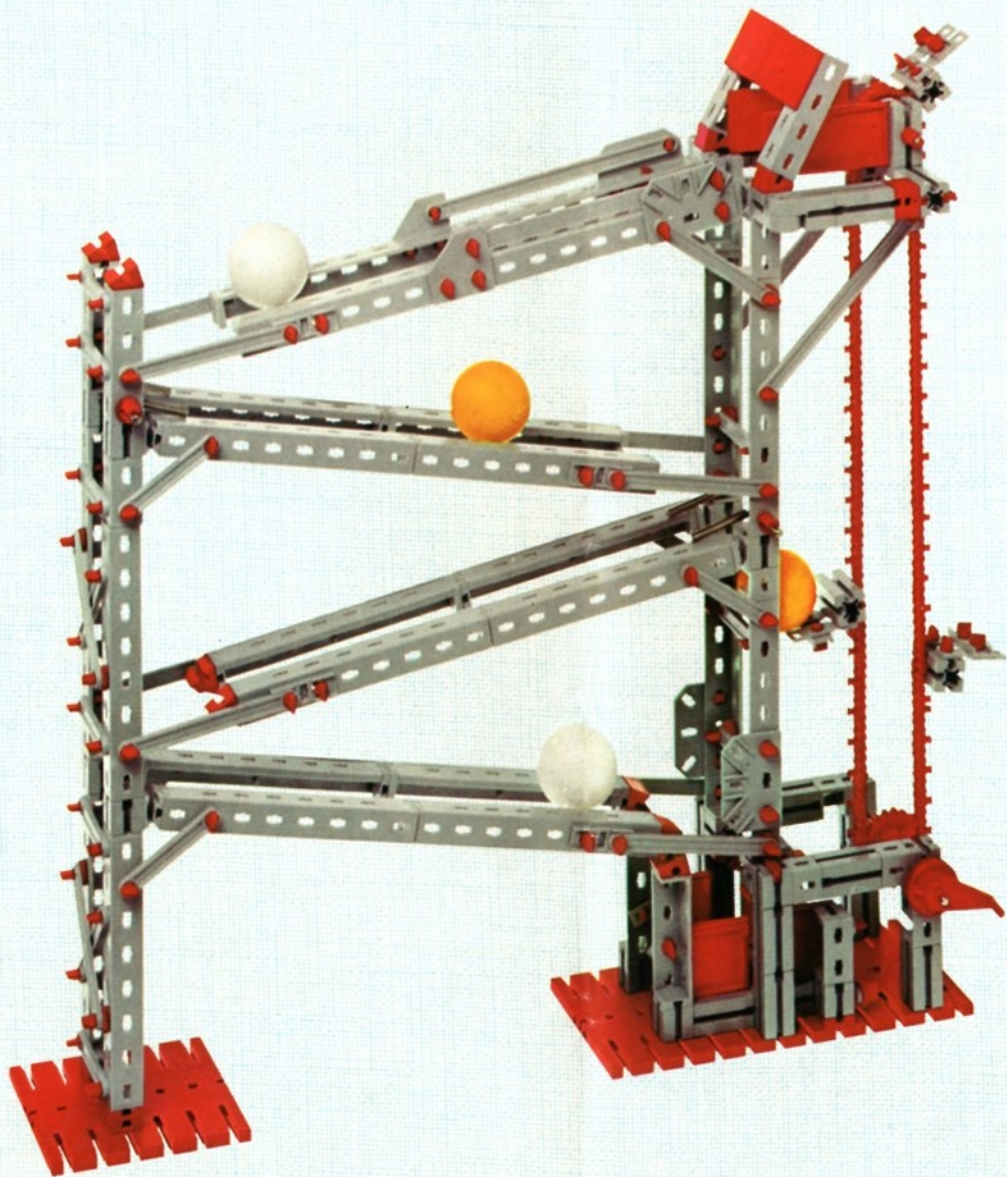

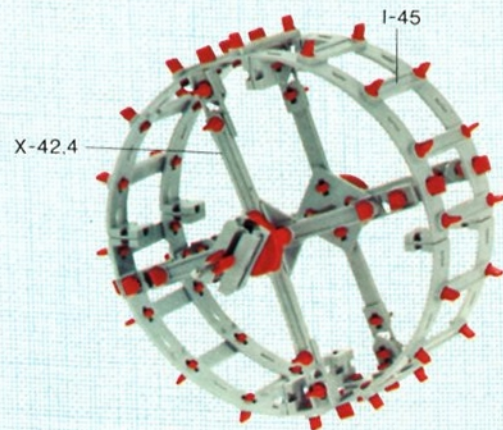
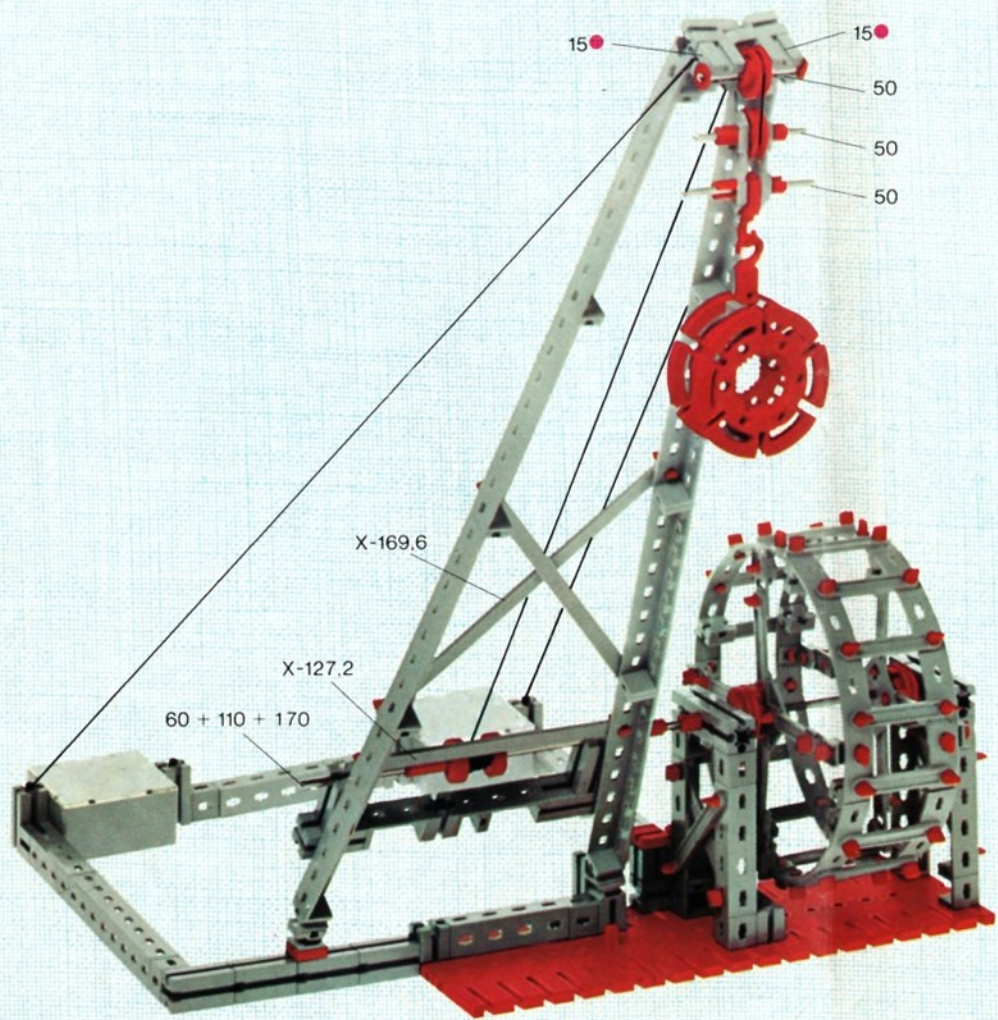

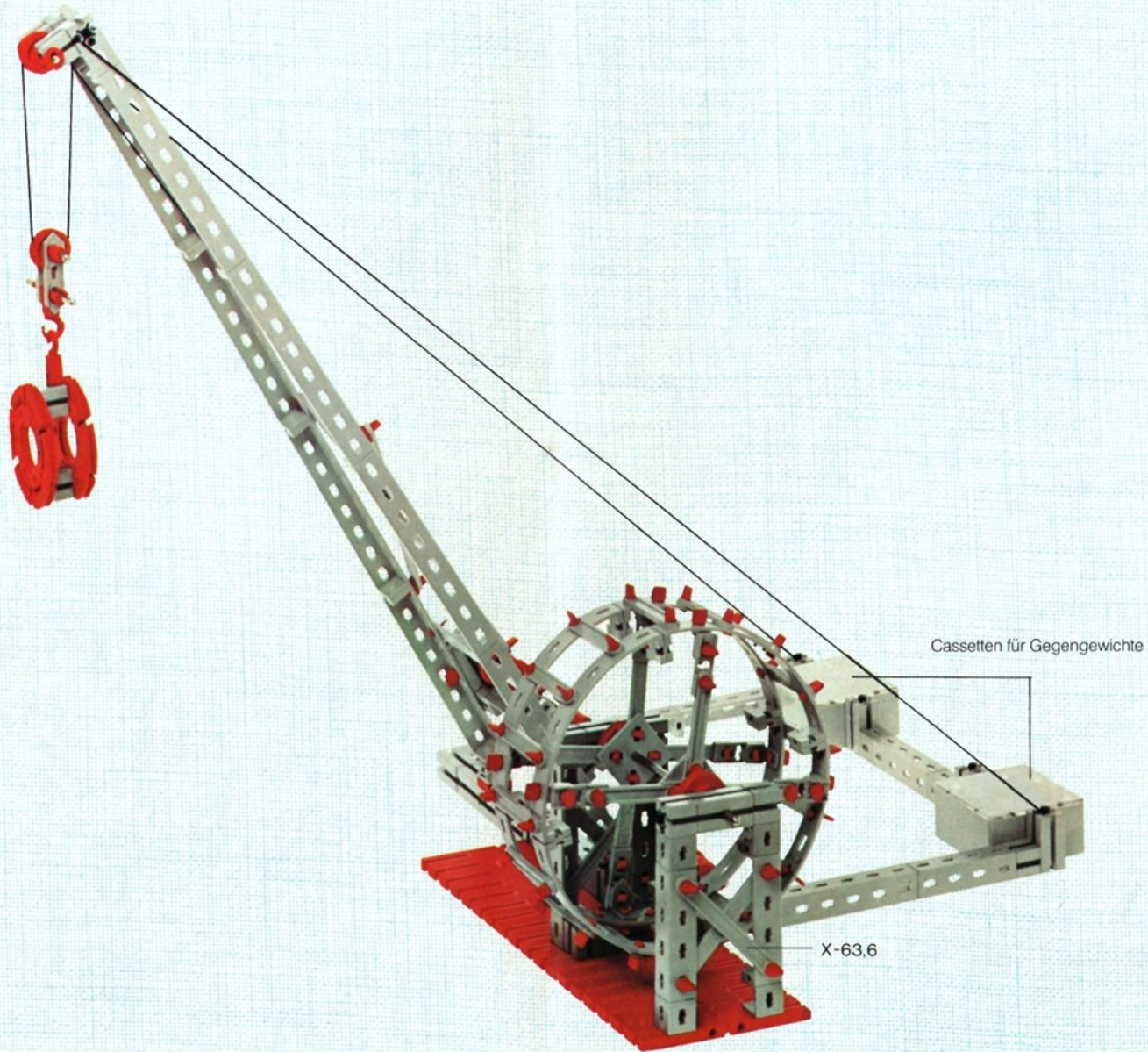

Cassetten für Gegengewichte

X-63,6

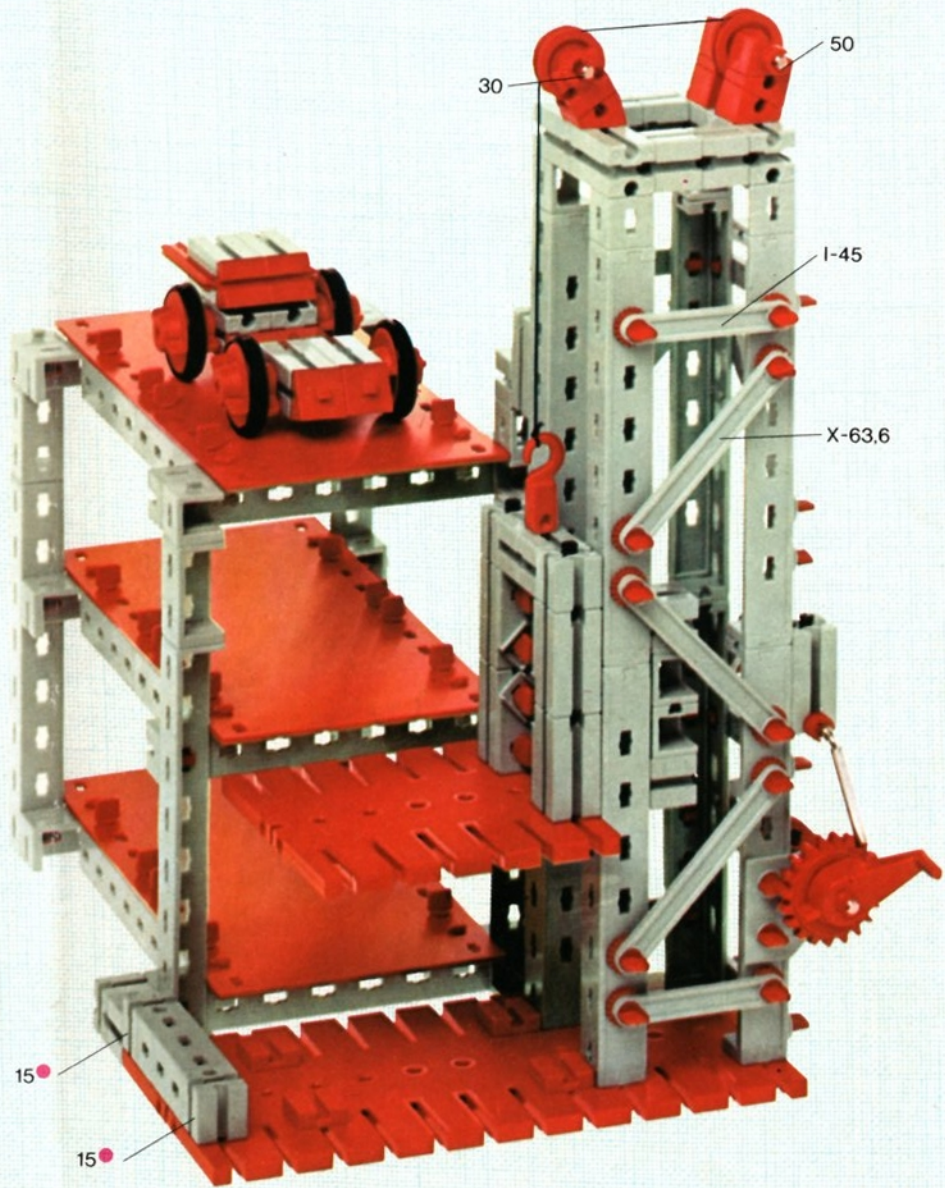
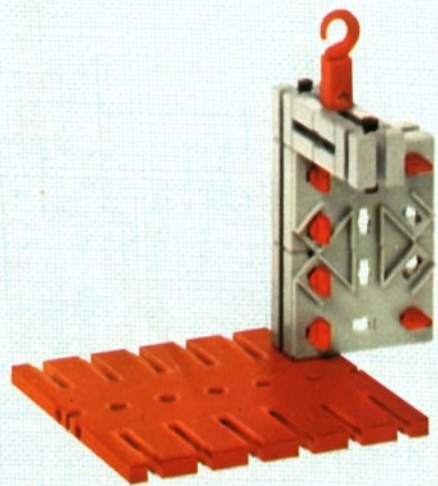

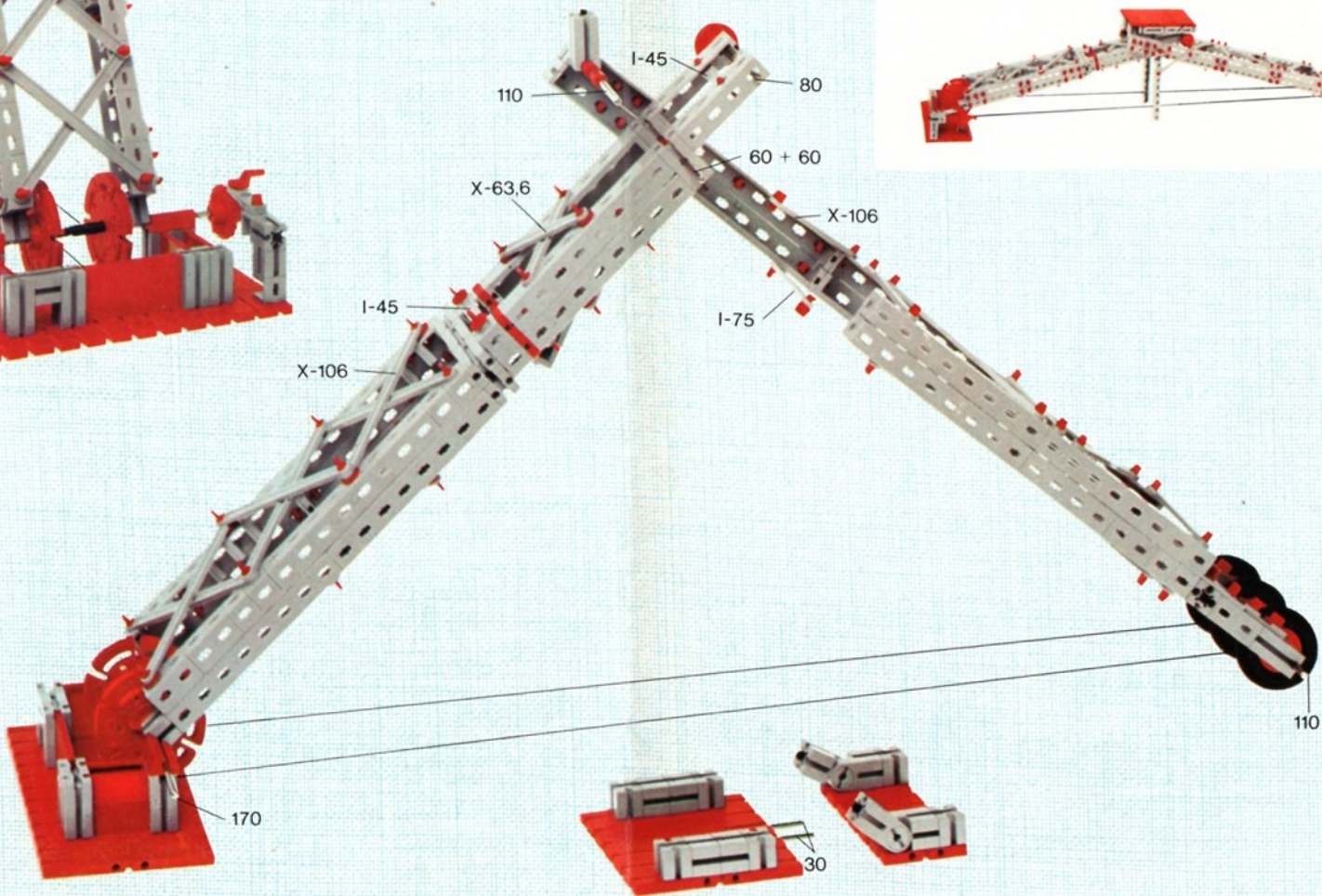
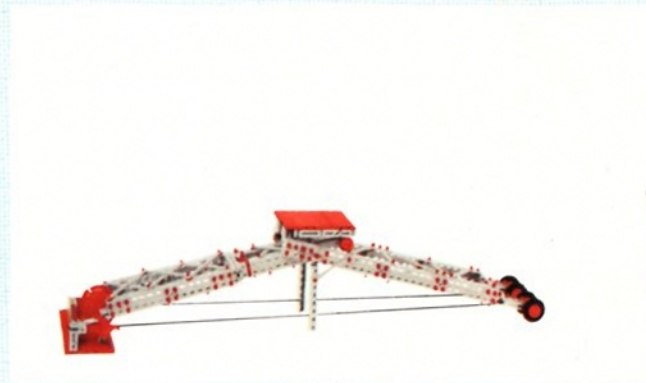

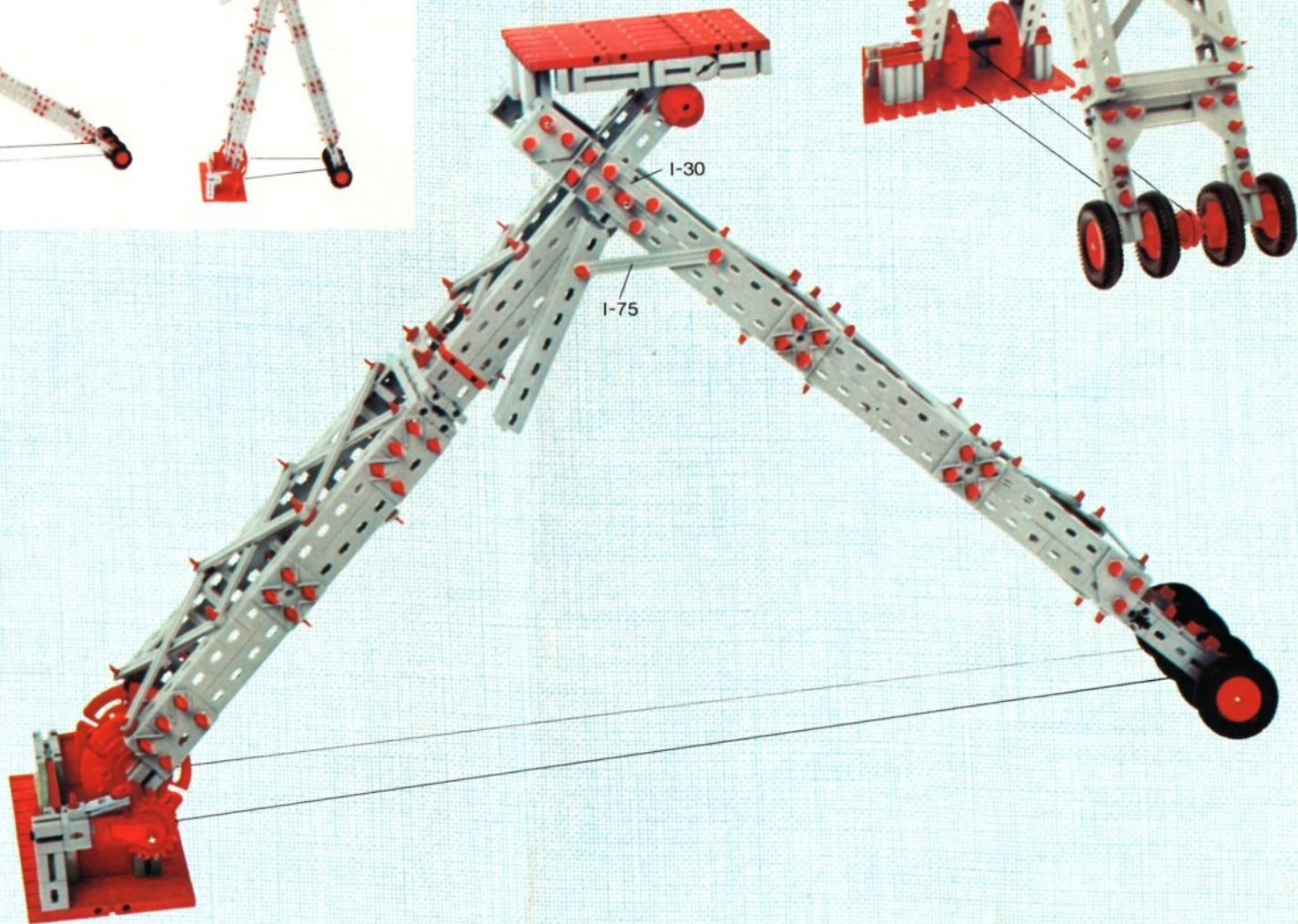

- + **Zusatzpackung ft 020**
- + **Accessory pack ft 020**
- + **Boîte de réassortiment ft 020**
- + **Aanvuldoosje ft 020**

fischer technik



020

Art.-Nr. 2303205
 Raupenkettten,
 Förderbecher

Track chains,
 conveyor
 buckets

chaîne de
 transmission avec
 accessoires pour
 véhicules chenilles,
 godets.

rupsbandenketting,
 transportbakken

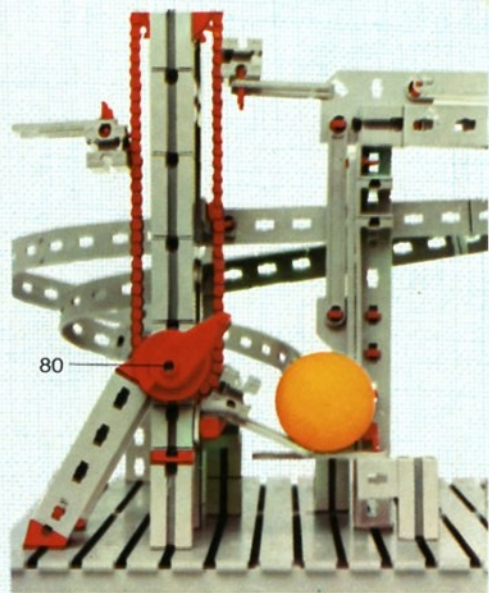
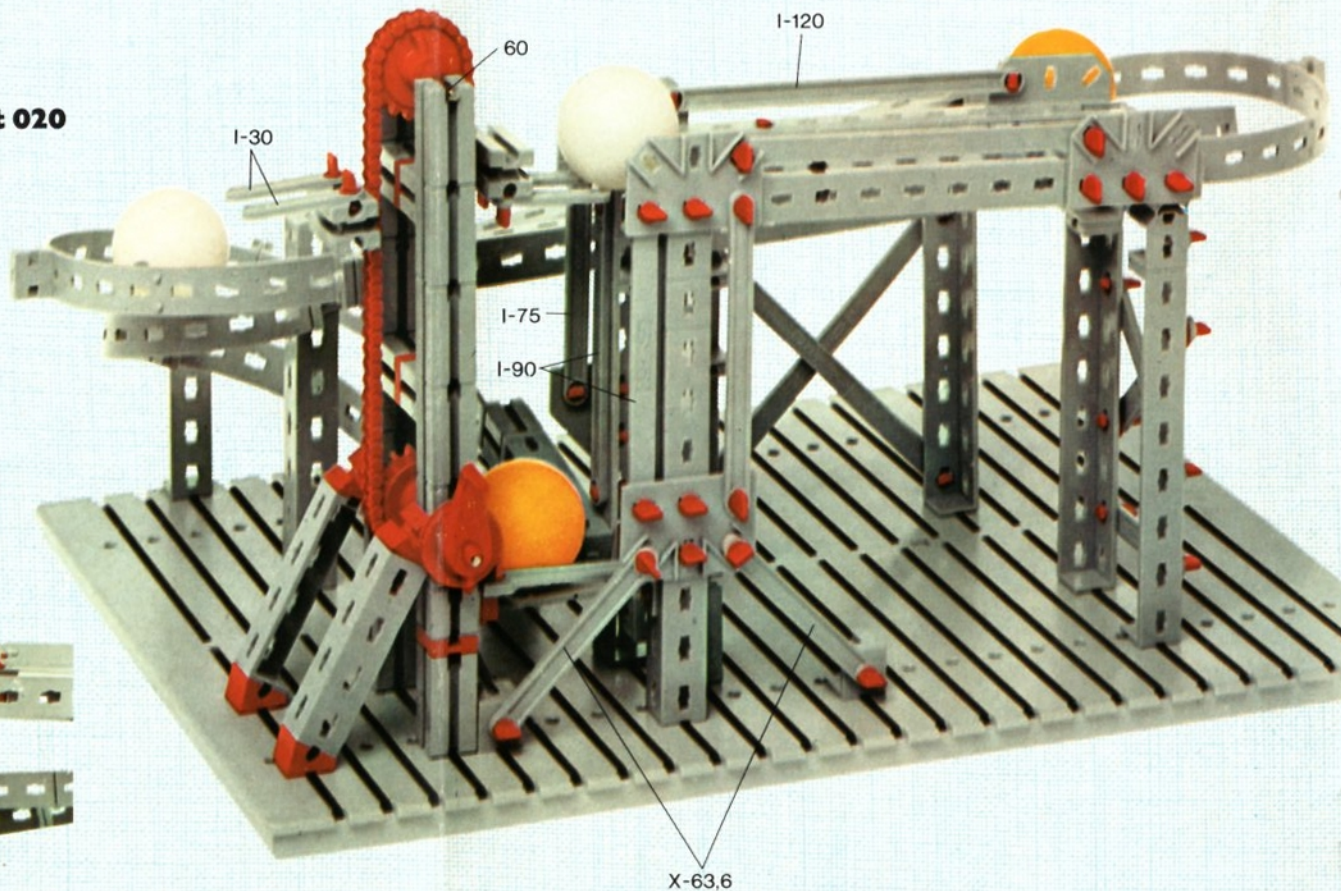

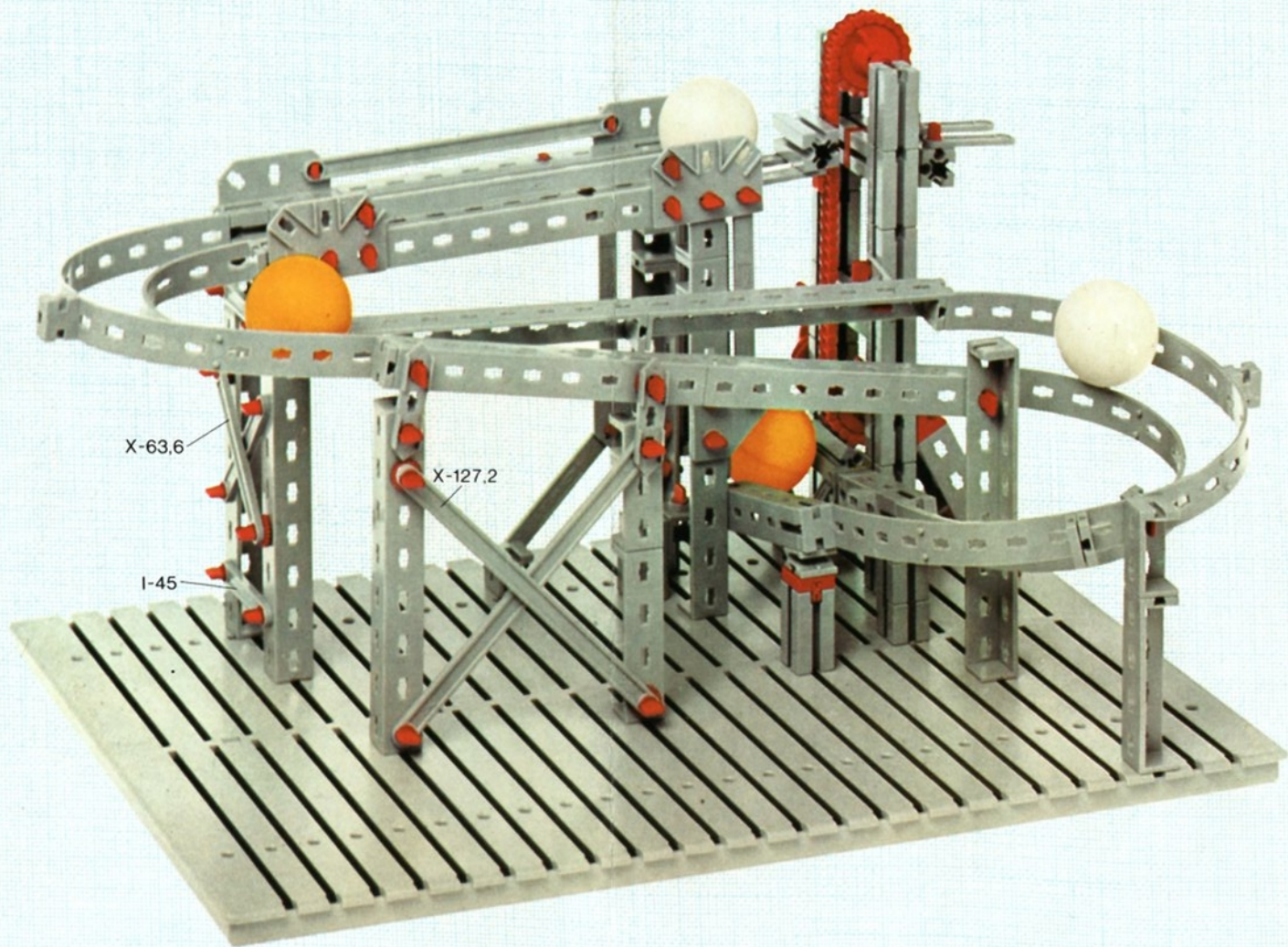

X-63.6

X-127.2

I-45

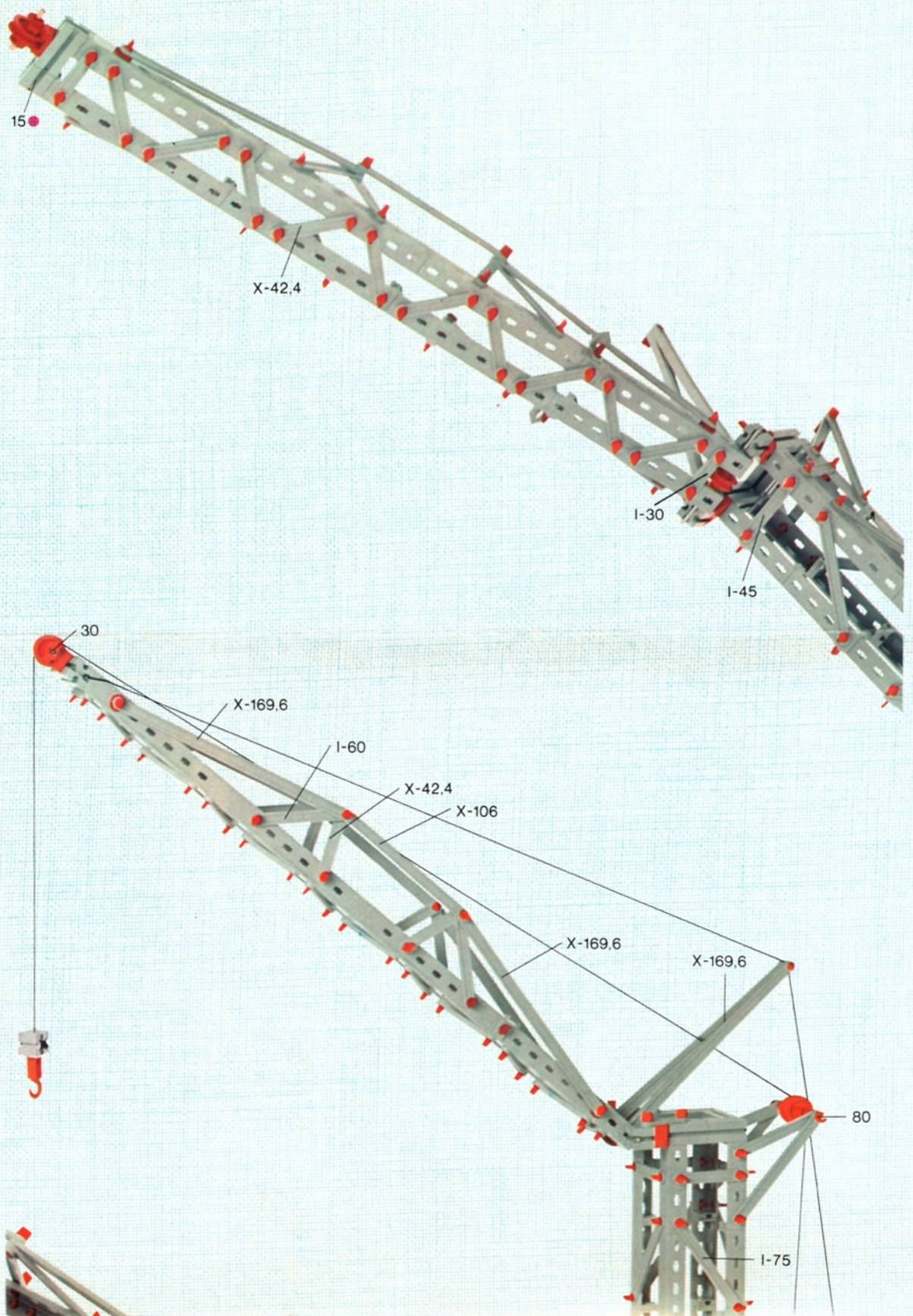

15

X-42.4

I-30

I-45

30

X-169.6

I-60

X-42.4

X-106

X-169.6

X-169.6

80

I-75

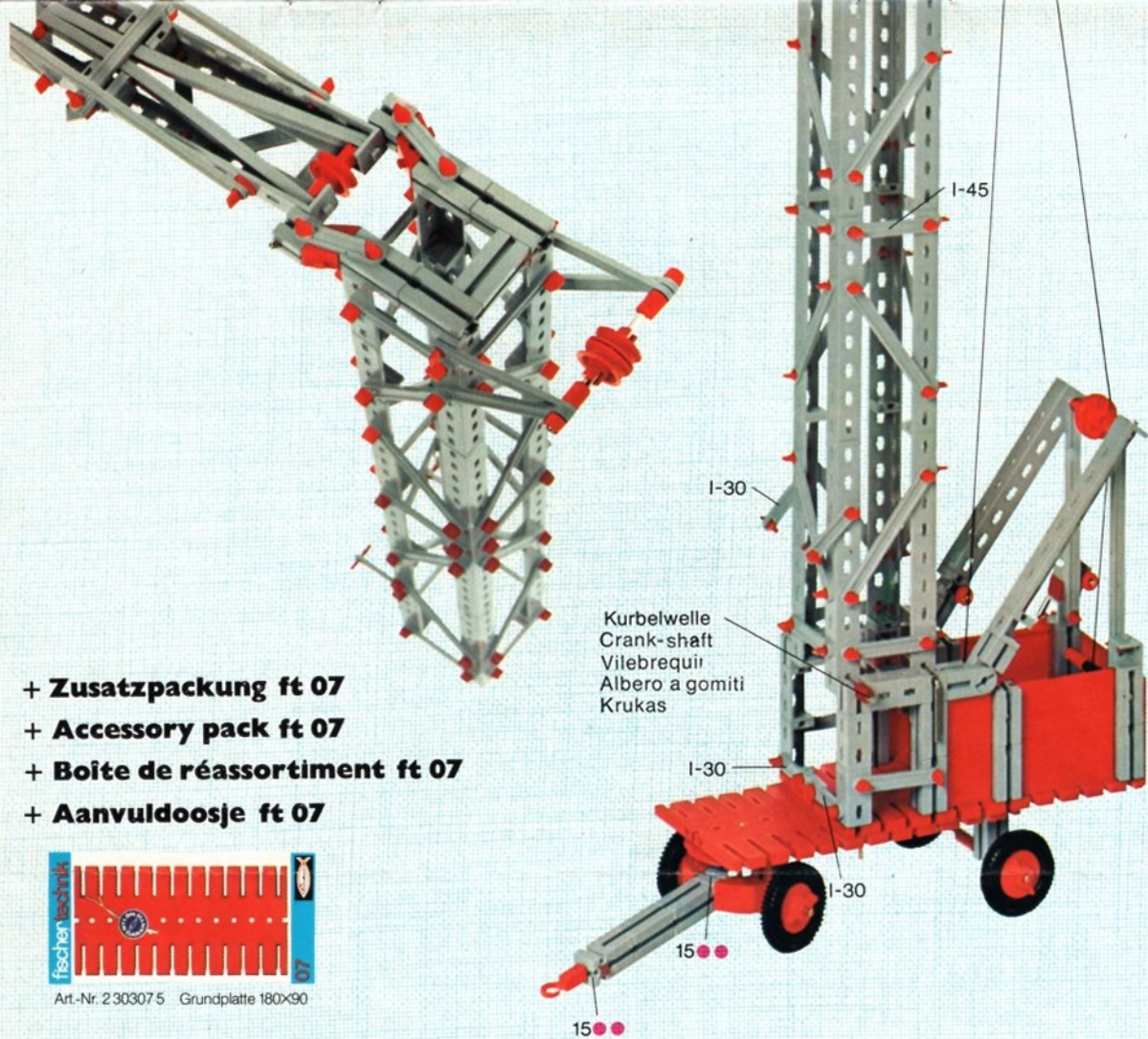

- + **Zusatzpackung ft 07**
- + **Accessory pack ft 07**
- + **Boîte de réassortiment ft 07**
- + **Aanvuldoosje ft 07**



Art.-Nr. 2303075 Grundplatte 180x90

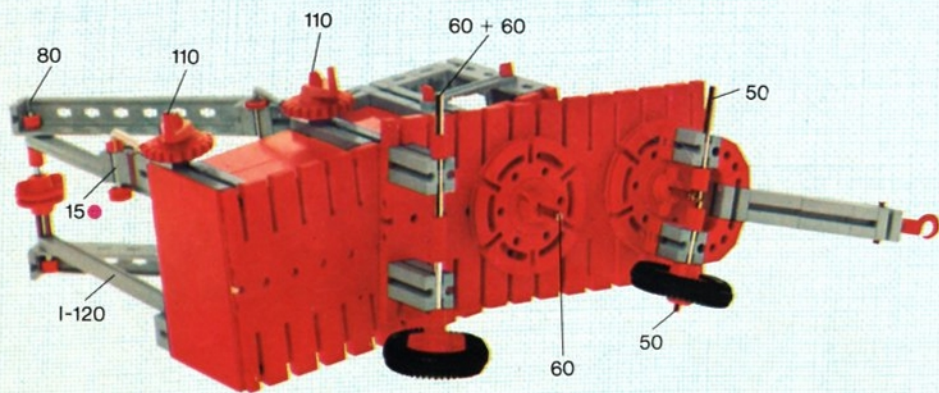



Stückliste · part list · nomenclature · elenco dei pezzi · onderdelen lijst

Abbildung	Artikel- Nummer	50 S/3 Stück	Benennung	Zusatz- kasten
	4 36300 1	4	Winkelträger 15 · angle girder 15 · cornière de 15 · trave angolare 15 · hoekdraagsteun 15	ft051 2
	4 36304 1	4	Winkelträger 15 mit 2 Zapfen · angle girder 15 with 2 lugs · élément de 15 à 2 tenons · trave angolare 15 con 2 pemi · hoekdraagsteun 15 met 2 kappen (pennen)	ft051 2
	4 36303 1	4	Winkelträger 120 · angle girder 120 · cornière de 120 · trave angolare 120 · hoekdraagsteun 120	ft051 4
	4 36305 1	4	Flachträger 120 · flat girder 120 · étrier de 120 · trave piatta 120 · vlakke draagsteun 120	ft057 3
	4 36307 1	4	Flachstück · flat strut · plat de · pezzo piatto · vlakke steun	ft057 5
	4 36306 1	12	Bogenstück 30° · curved strut, large radius · plat cintré de 30° · pezzo curvo raggio grande · boogstuk, grote radius	ft057 3
	4 36319 1	4	X-Strebe 127,2 · X-strut 127,2 · entretoise de 127,2 type X · diagonale X 127,2 · X-spant 127,2	ft056 2
	4 36320 1	8	X-Strebe 169,6 · X-strut 169,6 · entretoise de 169,6 type X · diagonale X 169,6 · X-spant 169,6	ft056 2
	4 36321 1	1	Platte 180×90 · plate 180×90 · plaque de 180×90 · piastra 180×90 · plaat 180×90	ft054 2
	3 36518 1	1	Kassette · case · coffret · cassetta · cassette	ft027 3
	4 36326 1	2	Lasche 15 · fish-plate 15 · éclisse de 15 · coprigiunto 15 · rechtverbindungsstück 15	ft053 4
	4 36327 1	4	Lasche 21,3 · fish-plate 21,3 · éclisse de 21,3 · coprigiunto 21,3 · rechtverbindungsstück 21,3	ft053 4
	4 36325 1	2	Eckknotenplatte · corner connector plate · gousset d'angle · piastra nodale angolare · hoekknoopplaat	ft053 2
	4 36322 1	4	Kreuzknotenplatte · nodal connector plate · gousset à croisillon · piastra nodale a croce · kruisknoopplaat	ft053 2
	4 35797 1	4	Doppelknotenplatte · dual connector plate · gousset piastra nodale doppia · dubbele knoopplaat	ft053 2

