

# fischer<sup>®</sup>technik

Ergänzung zu den Grundkästen

## Statik I

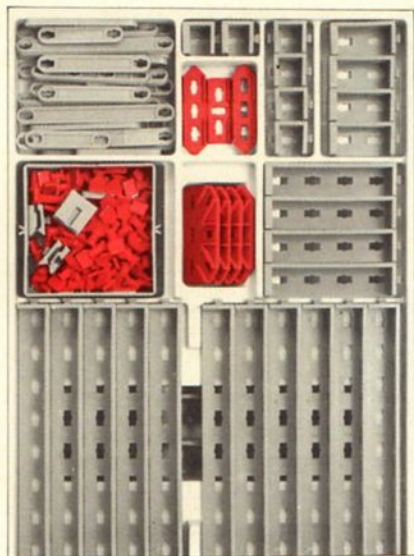

Zusammenbau der  
Einzelteile  
This is how the parts  
fit together  
Assemblage des  
pièces  
Aan elkaar verbinden  
van de onderdelen

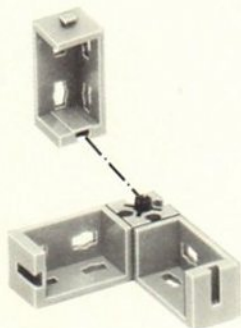
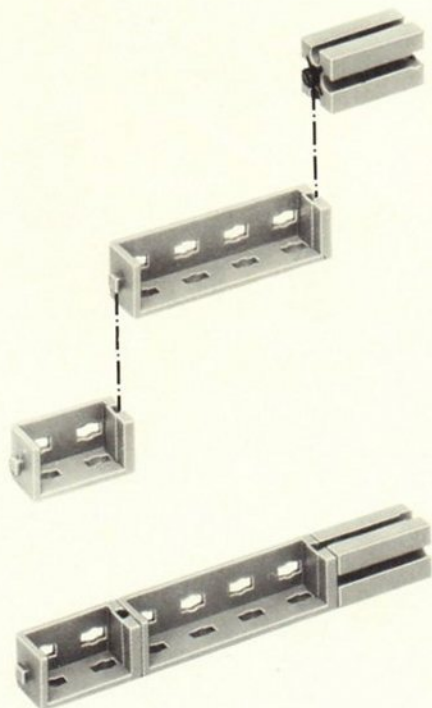

Zusammenbau der Einzelteile  
This is how the parts fit together  
Assemblage des pièces  
Aan elkaar verbinden van de onderdelen

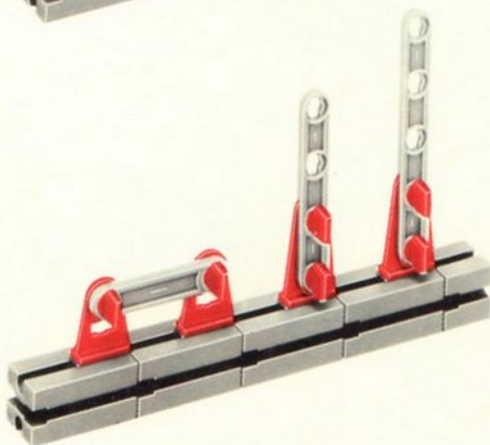
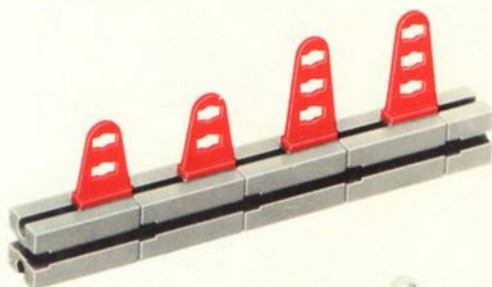
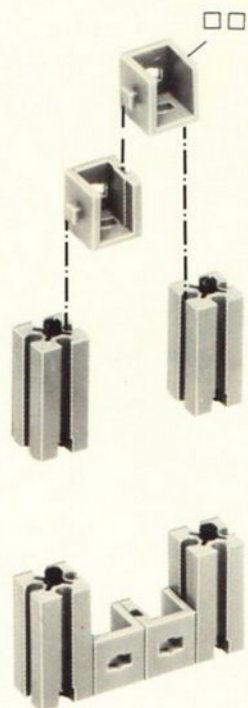

**Zusammenbau der Einzelteile**  
**This is how the parts fit together**  
**Assemblage des pièces**  
**Aan elkaar verbinden van de onderdelen**

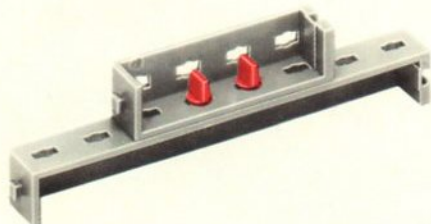
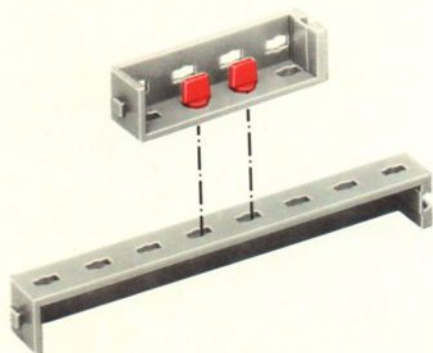



Zusammenbau der  
Einzelteile  
This is how the parts  
fit together  
Assemblage des  
pièces  
Aan elkaar verbinden  
van de onderdelen

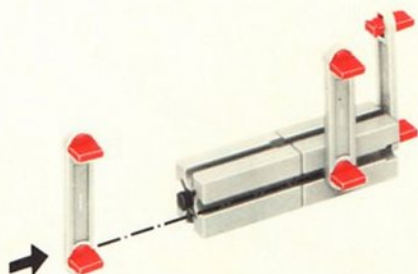
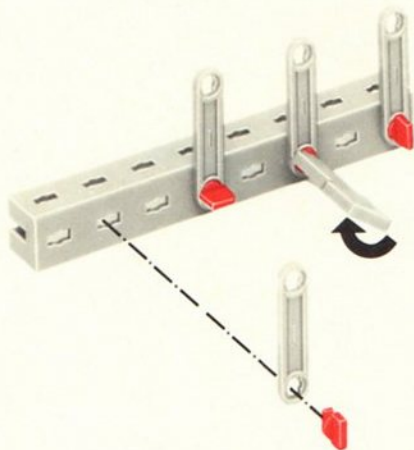

Zusammenbau der Einzelteile  
This is how the parts fit together  
Assemblage des pièces  
Aan elkaar verbinden van de onderdelen

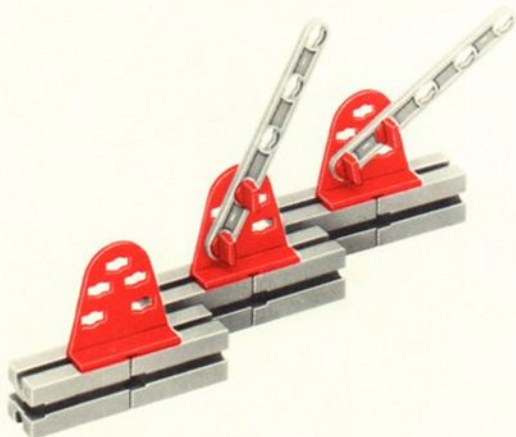
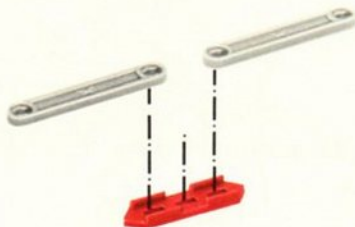
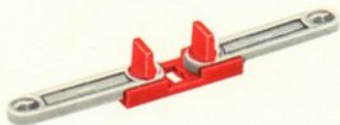
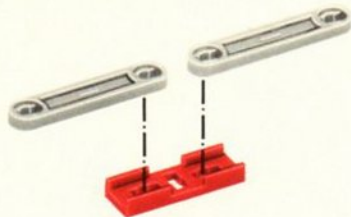

Zusammenbau der  
Einzelteile  
This is how the parts  
fit together  
Assemblage des  
pièces  
Aan elkaar verbinden  
van de onderdelen

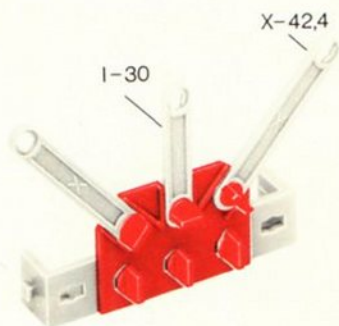
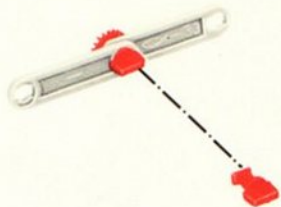

Zusammenbau der Einzelteile  
This is how the parts fit together  
Assemblage des pièces  
Aan elkaar verbinden van de onderdelen

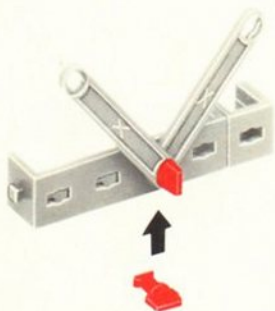



Zusammenbau der Einzelteile  
This is how the parts fit together  
Assemblage des pièces  
Aan elkaar verbinden van de onderdelen

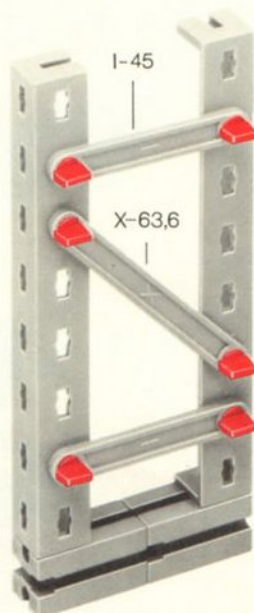
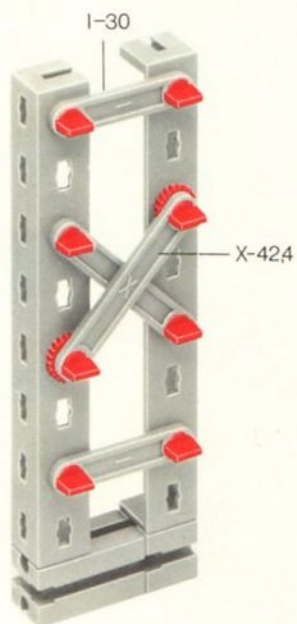
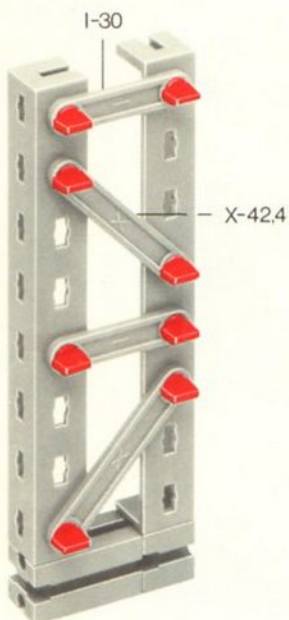

Zusammenbau der Einzelteile  
This is how the parts fit together  
Assemblage des pièces  
Aan elkaar verbinden van de onderdelen

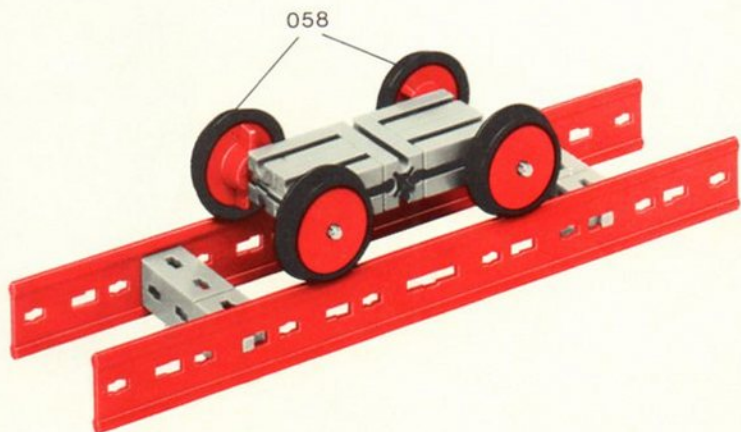
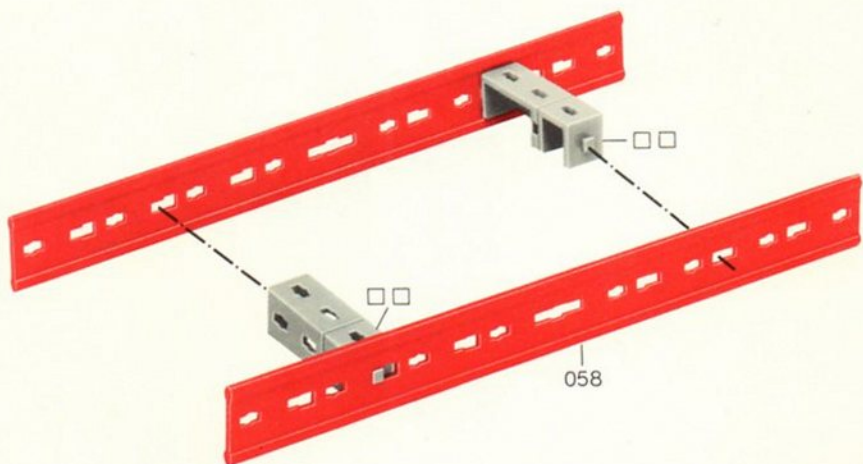
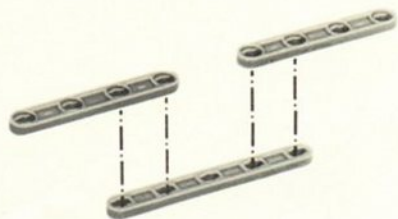

Zusammenbau der  
Einzelteile  
This is how the parts  
fit together  
Assemblage des  
pièces  
Aan elkaar verbinden  
van de onderdelen

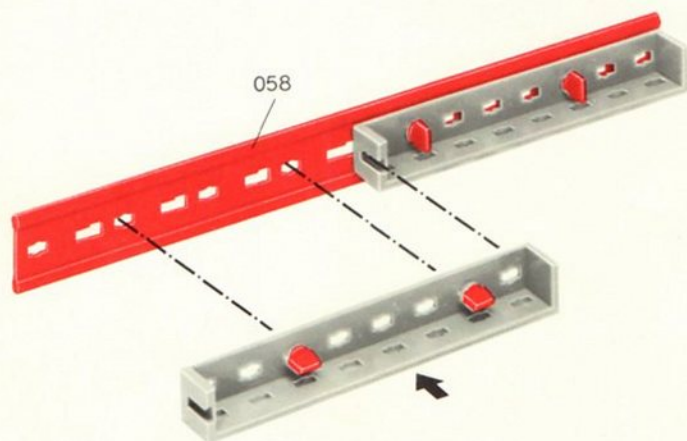
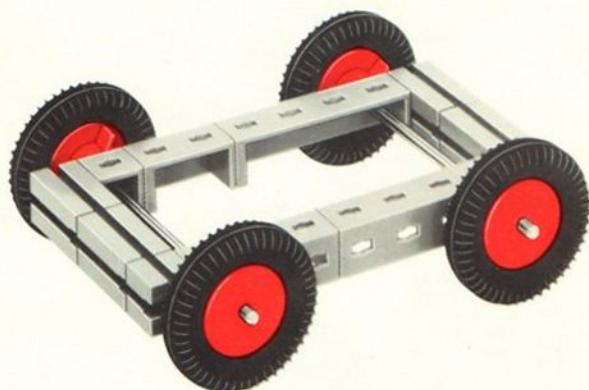
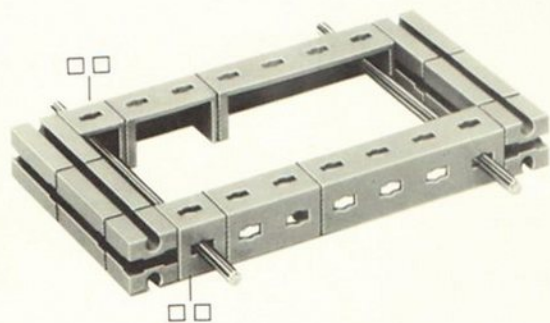

Statik 1 + 50

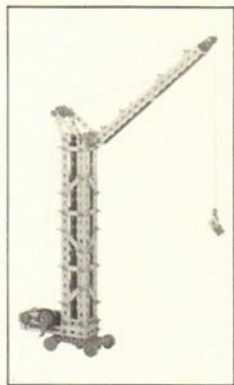
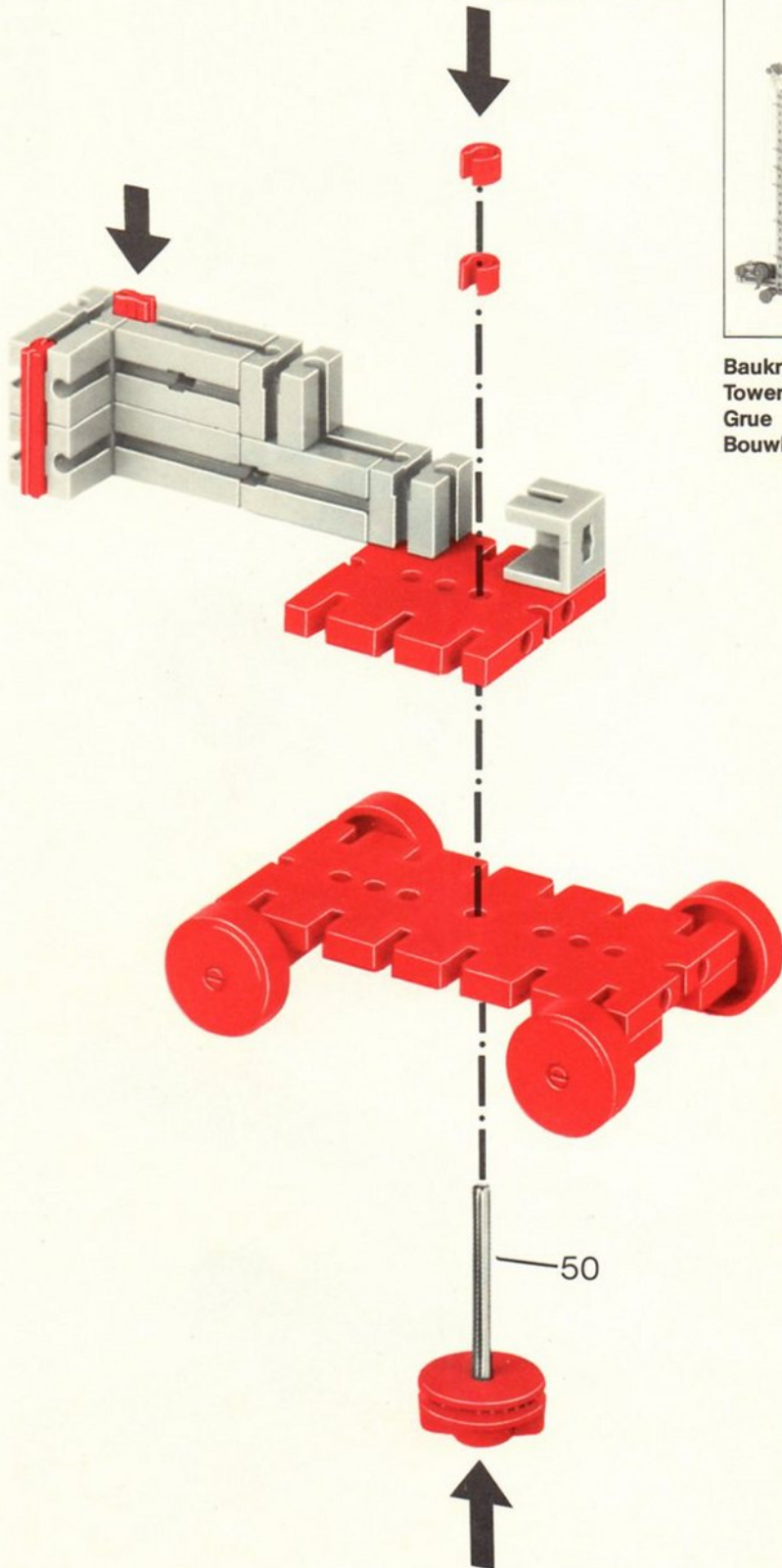

Baukran  
Tower crane  
Grue  
Bouwkraan



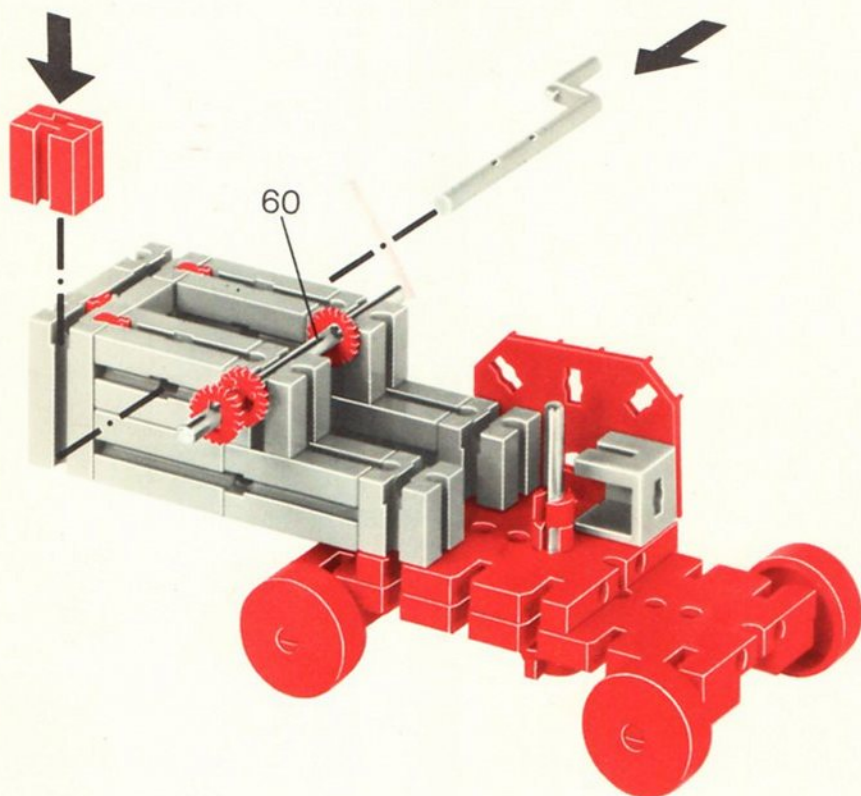
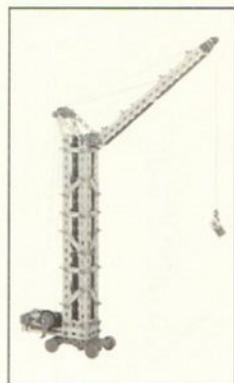



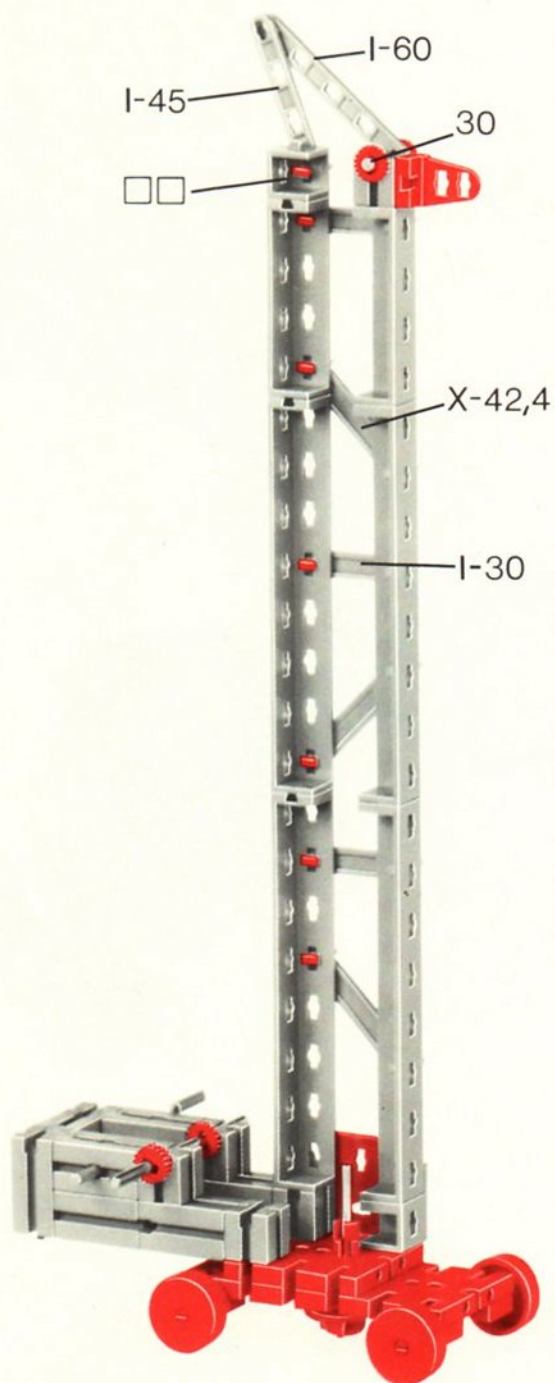
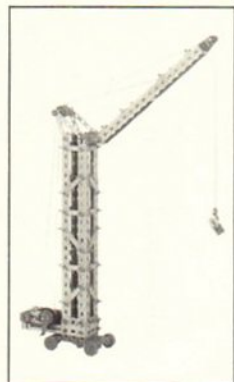

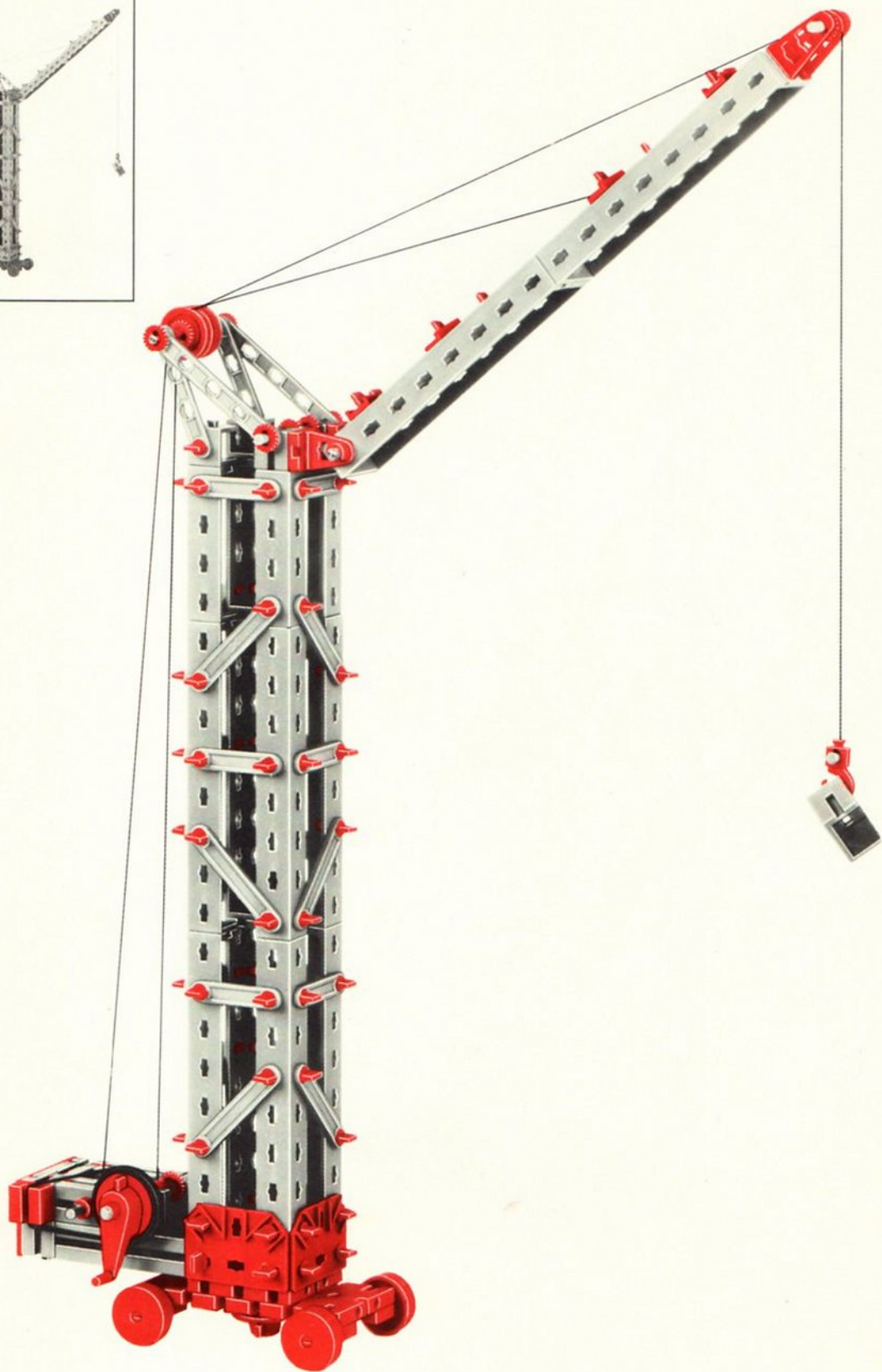
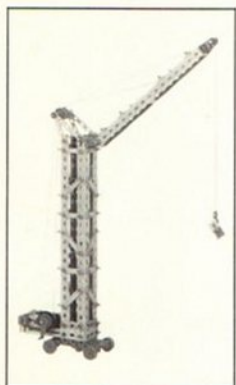

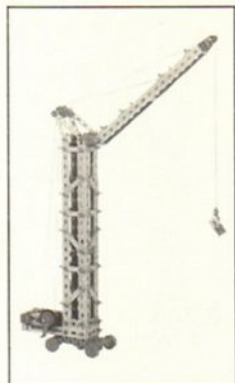
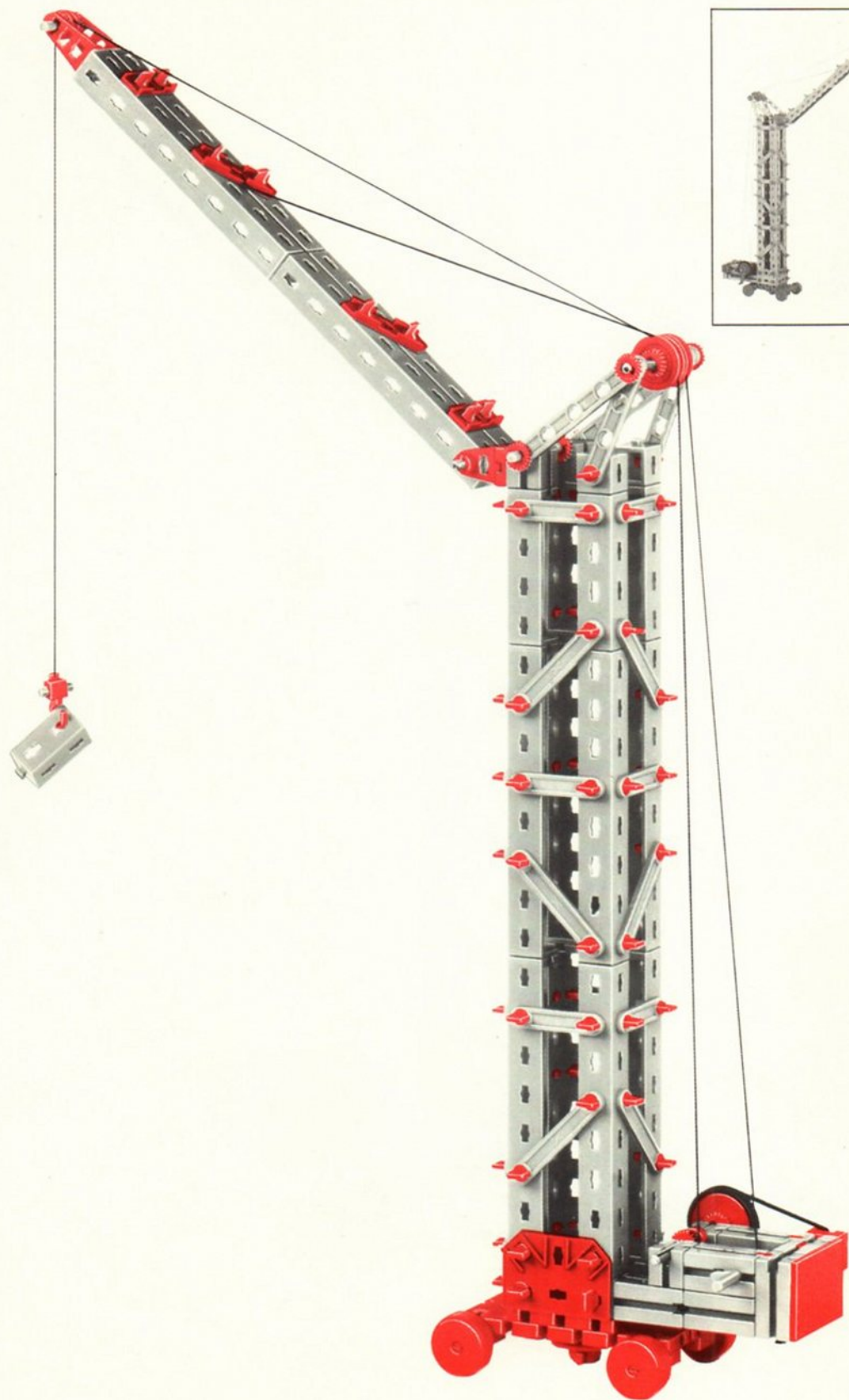

Statik 1 + 50



Aufzug  
Lift  
Monte-charge  
Lift

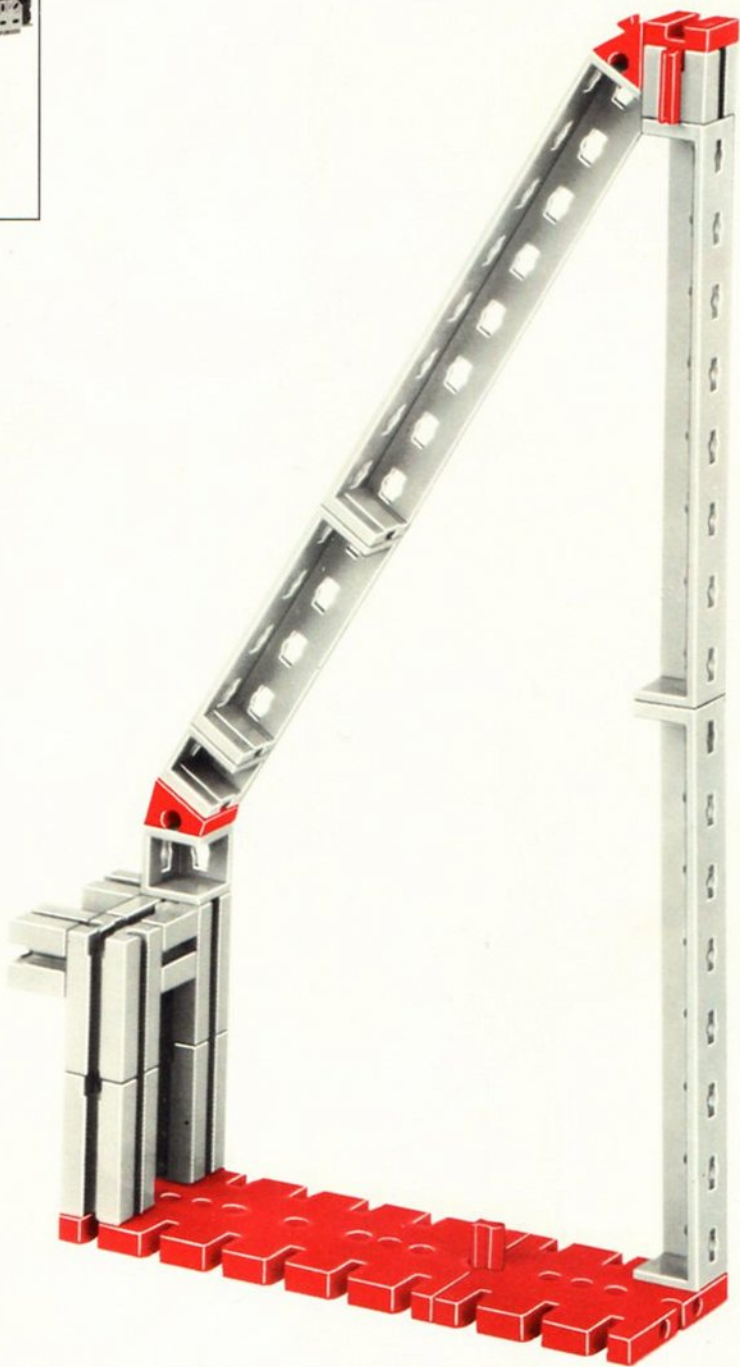



Statik 1 + 50

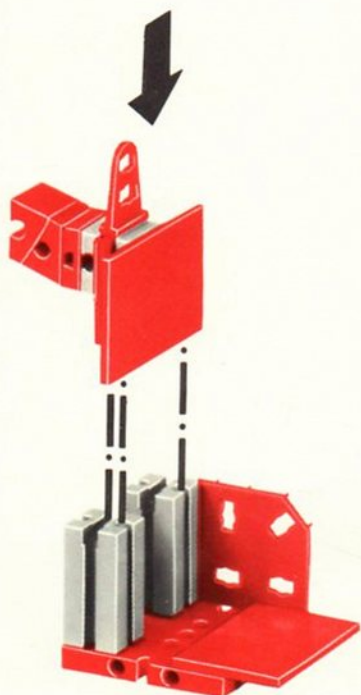
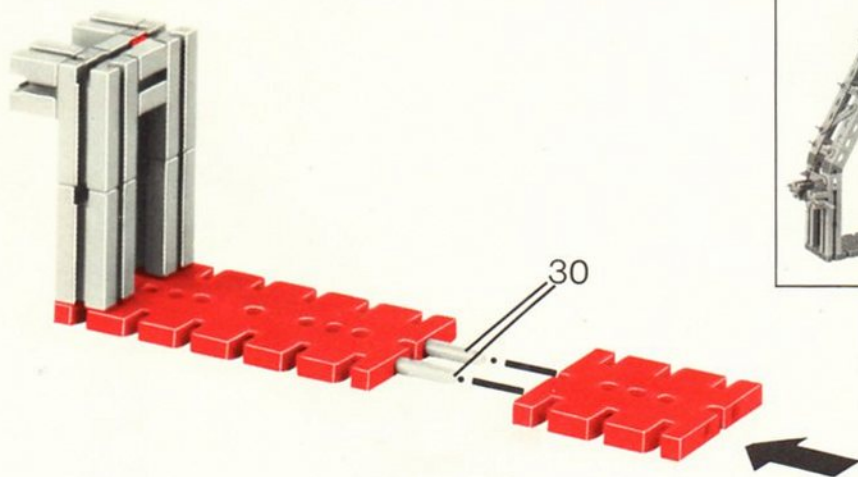



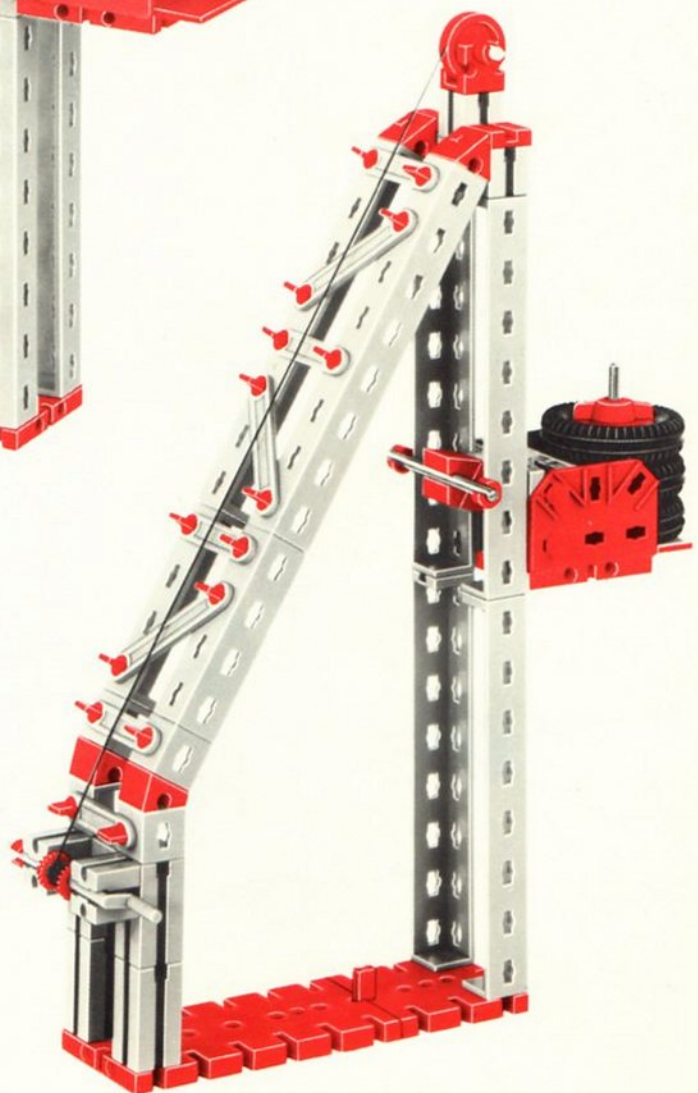
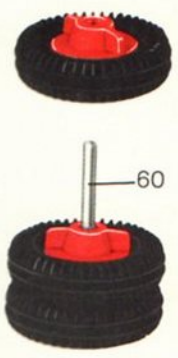
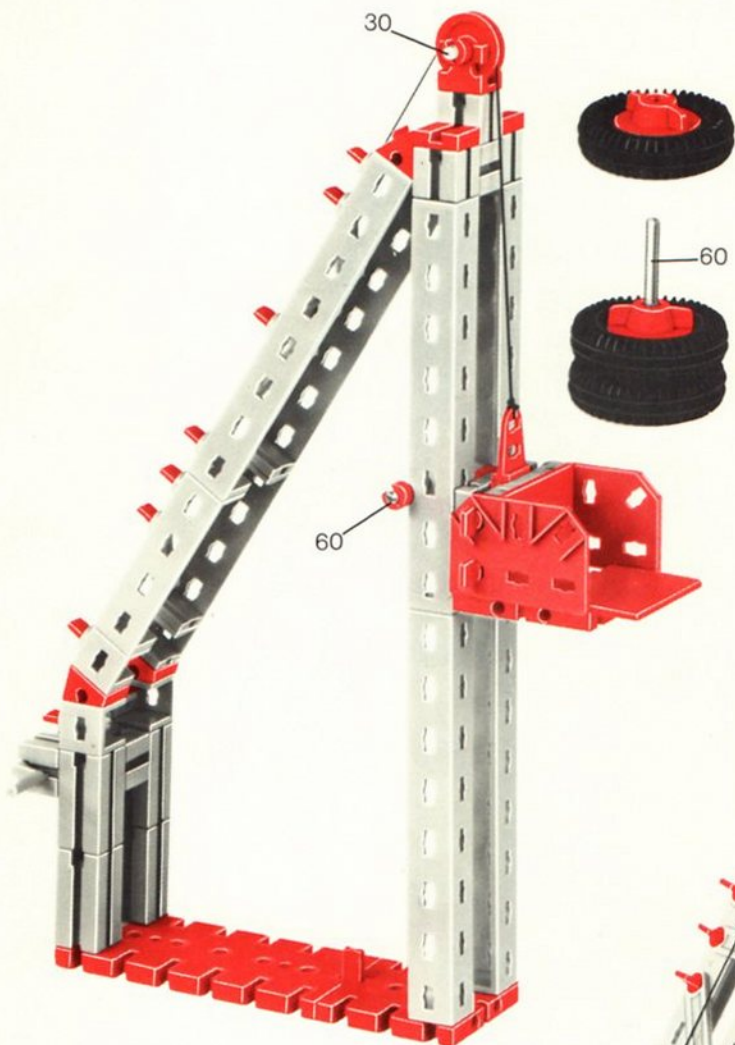

# Statik 1 + 100



Sendeturm  
A large broadcast  
tower  
Télécommunications  
Zendertoren

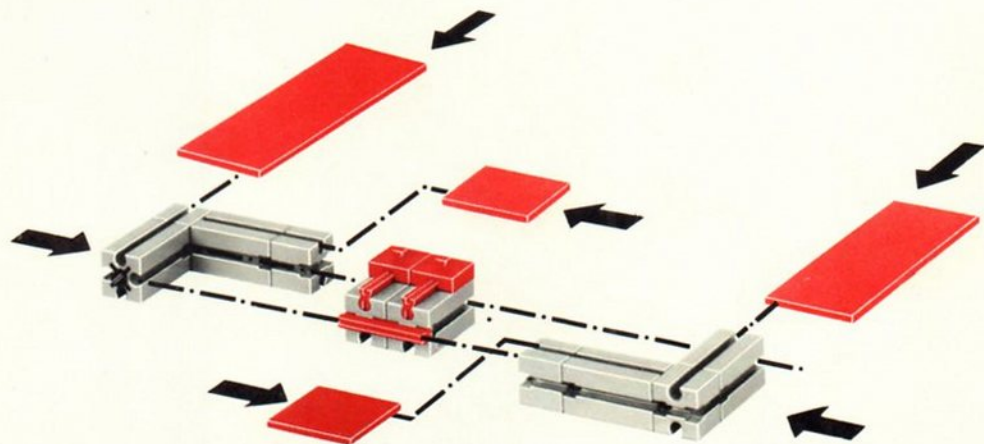
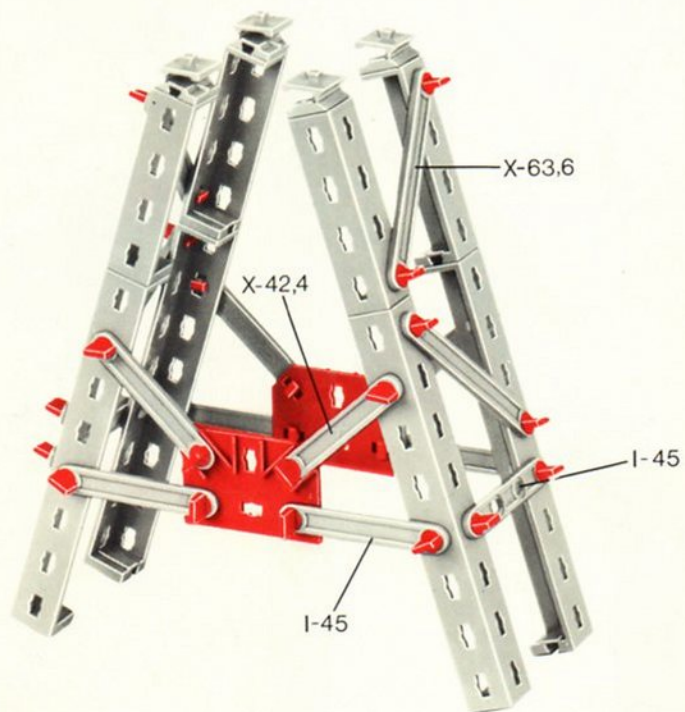

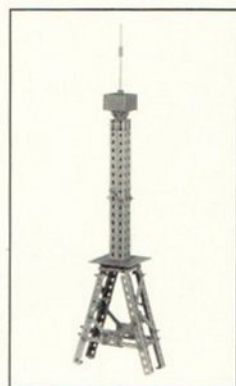



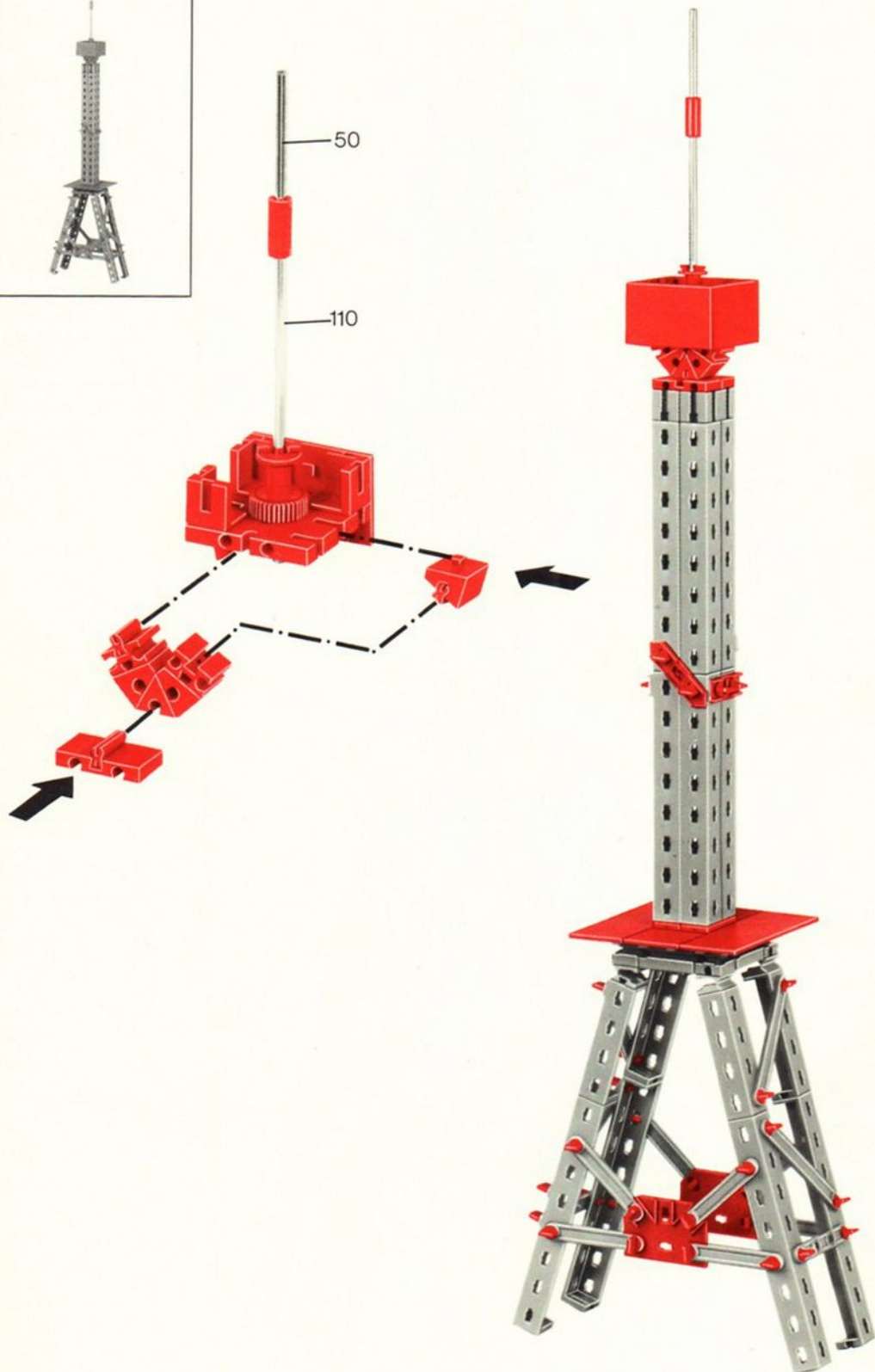
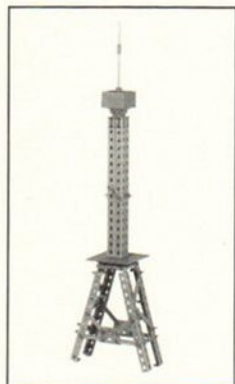



Kranwagen  
Heavy duty mobile  
crane  
Grue mobile  
Kraanwagen

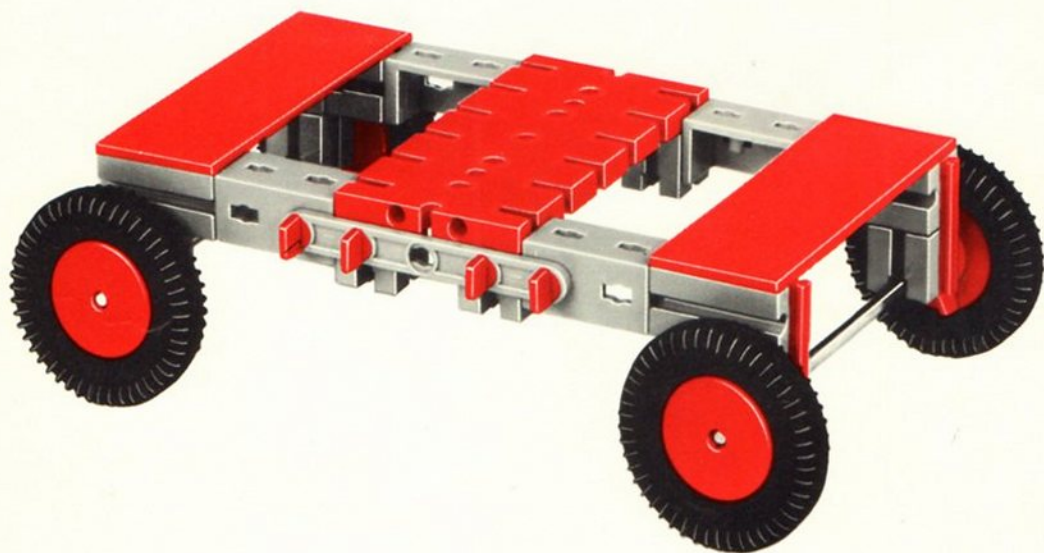
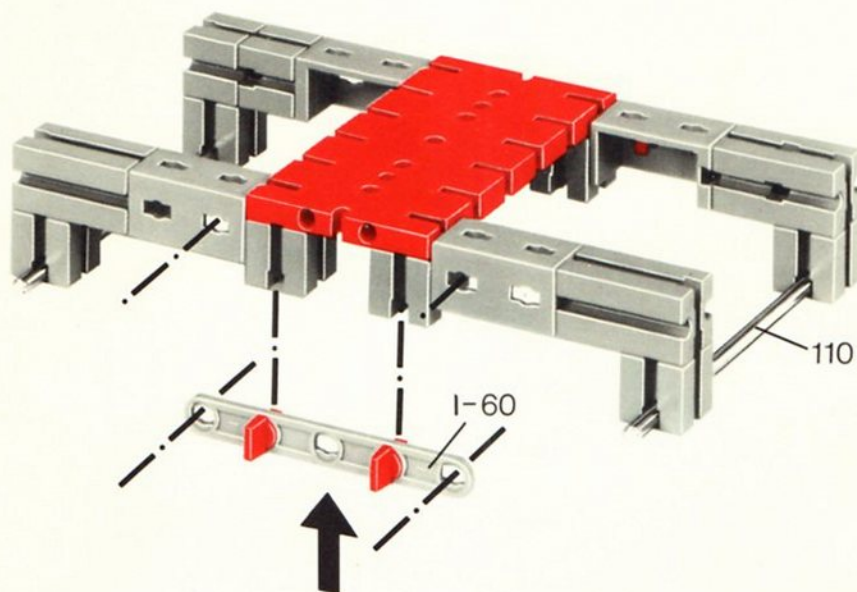



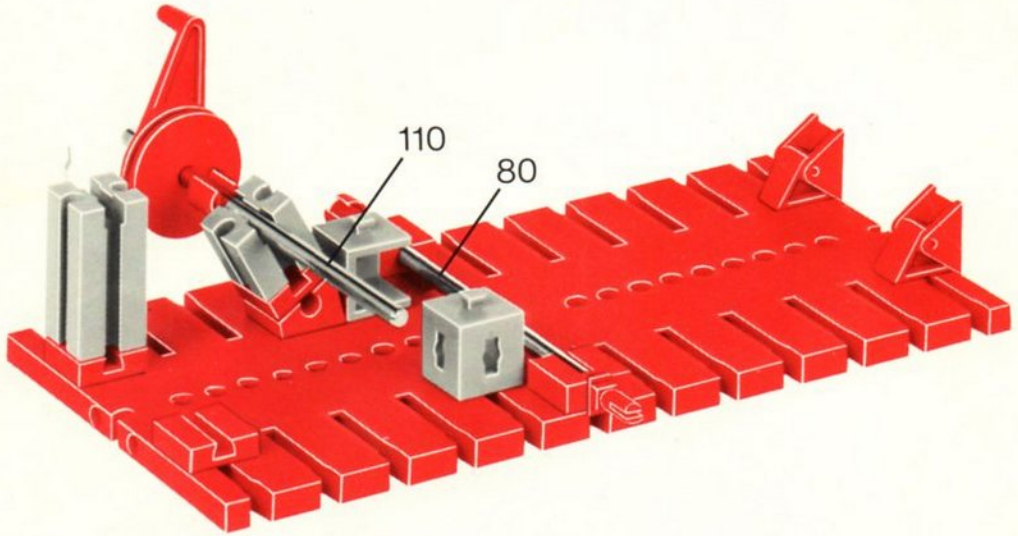

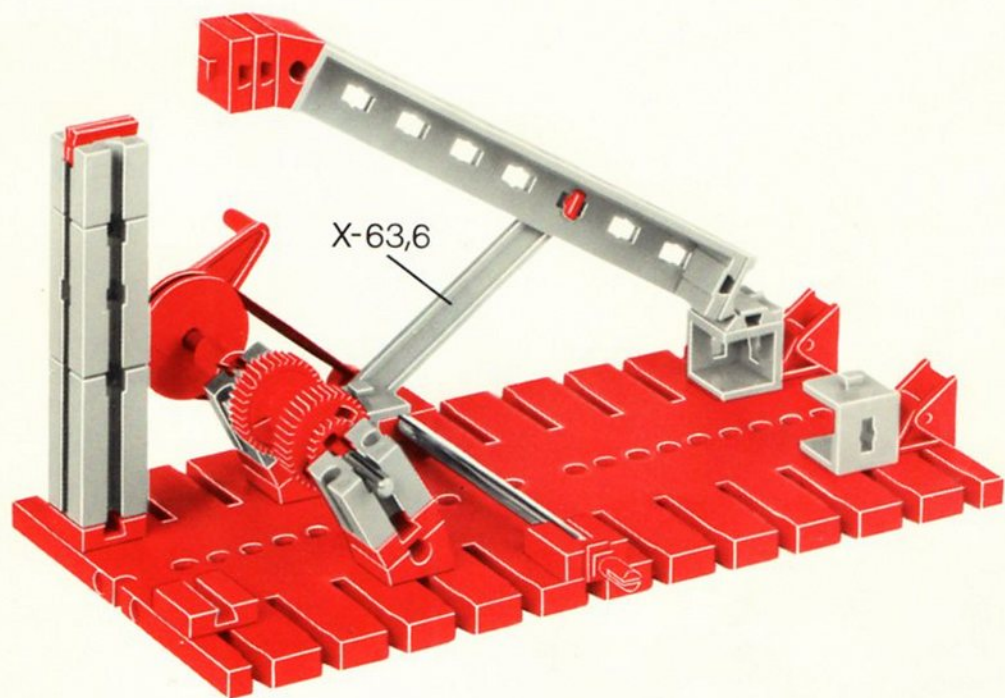

X-63,6

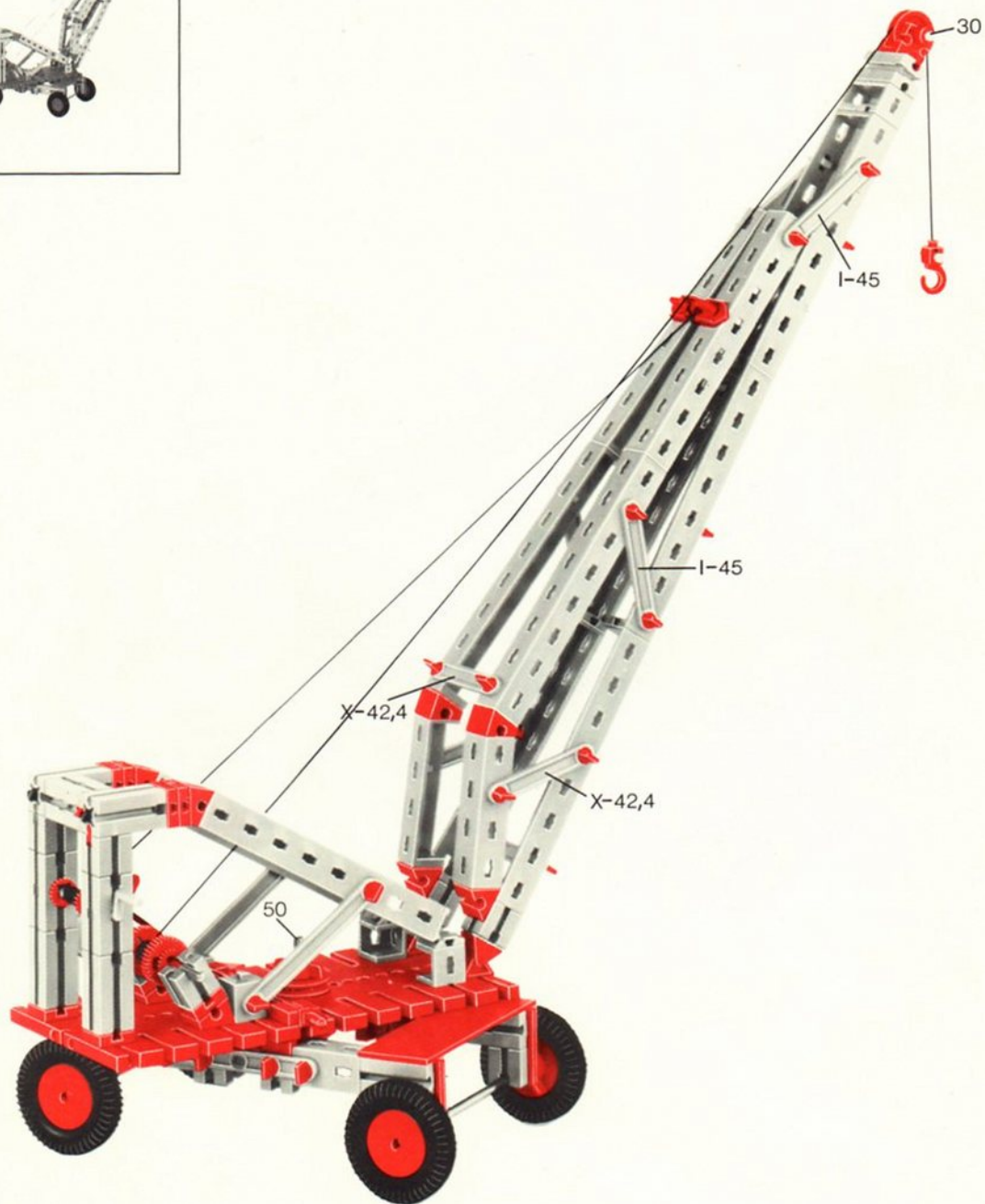

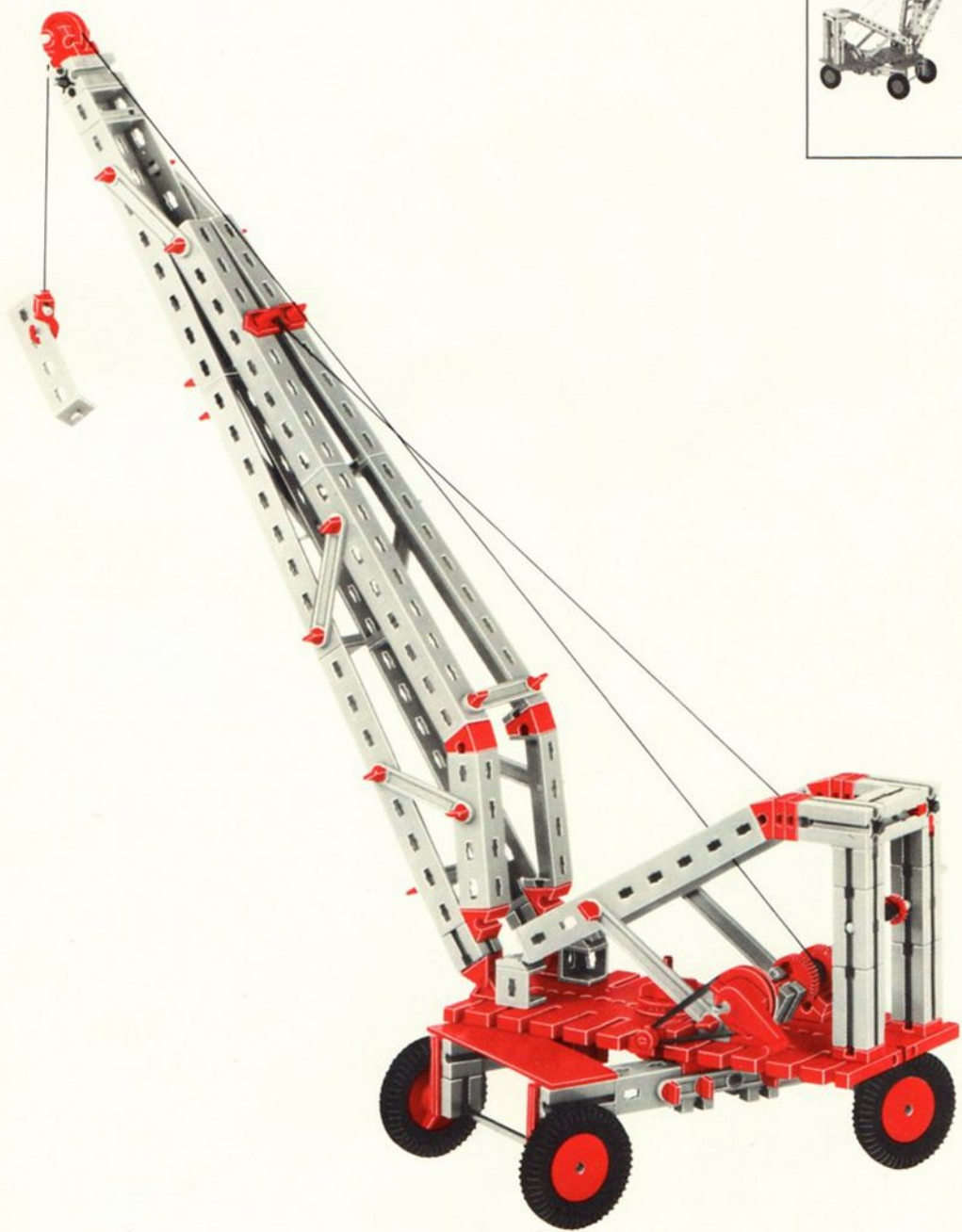



# Statik 1 + 200



Abschleppwagen  
Tow truck  
Dépanneuse  
Sleepwagen

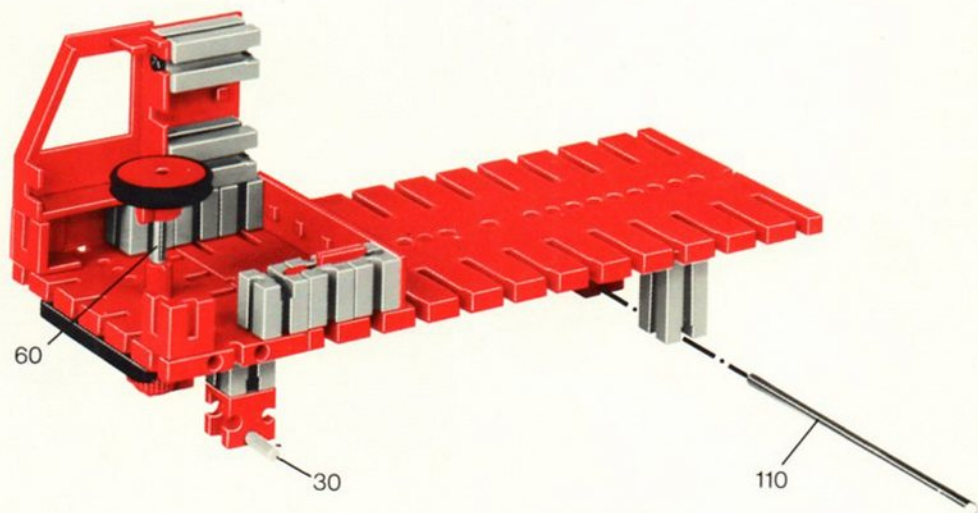
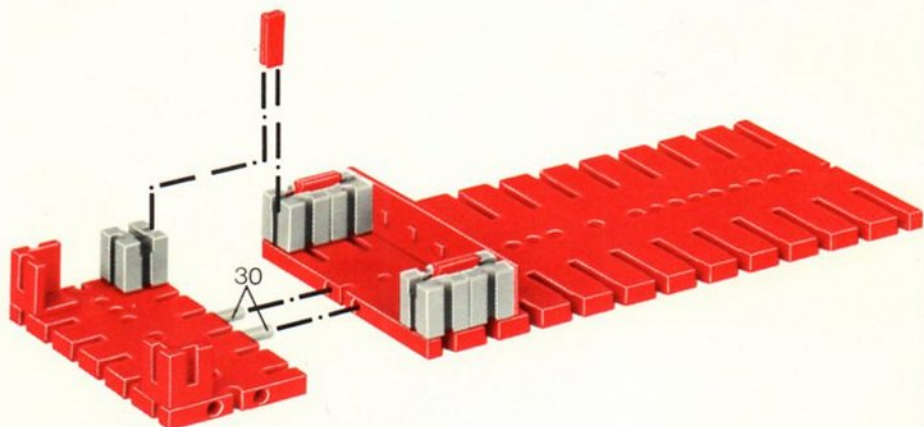

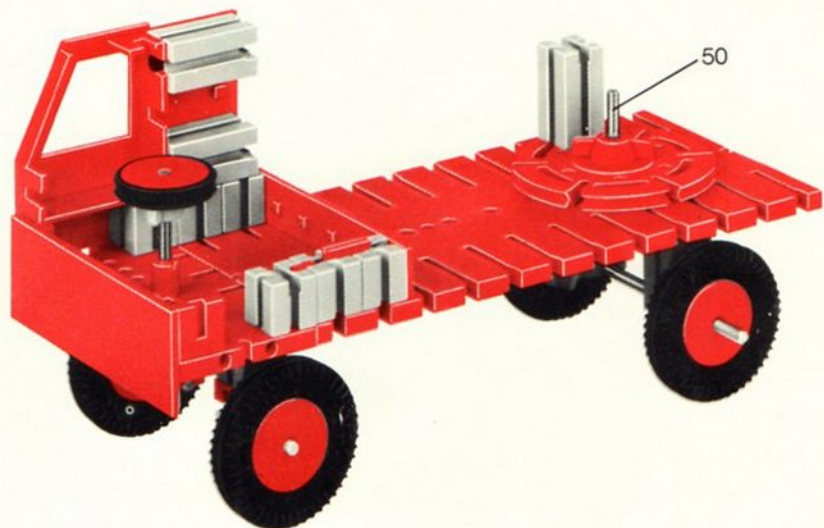
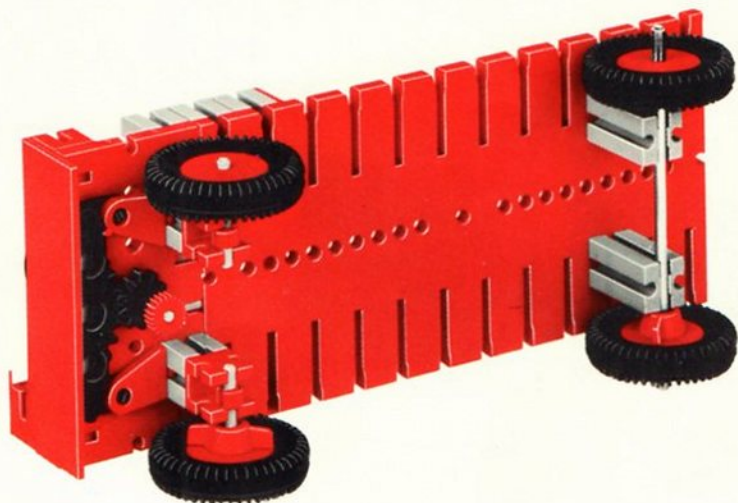

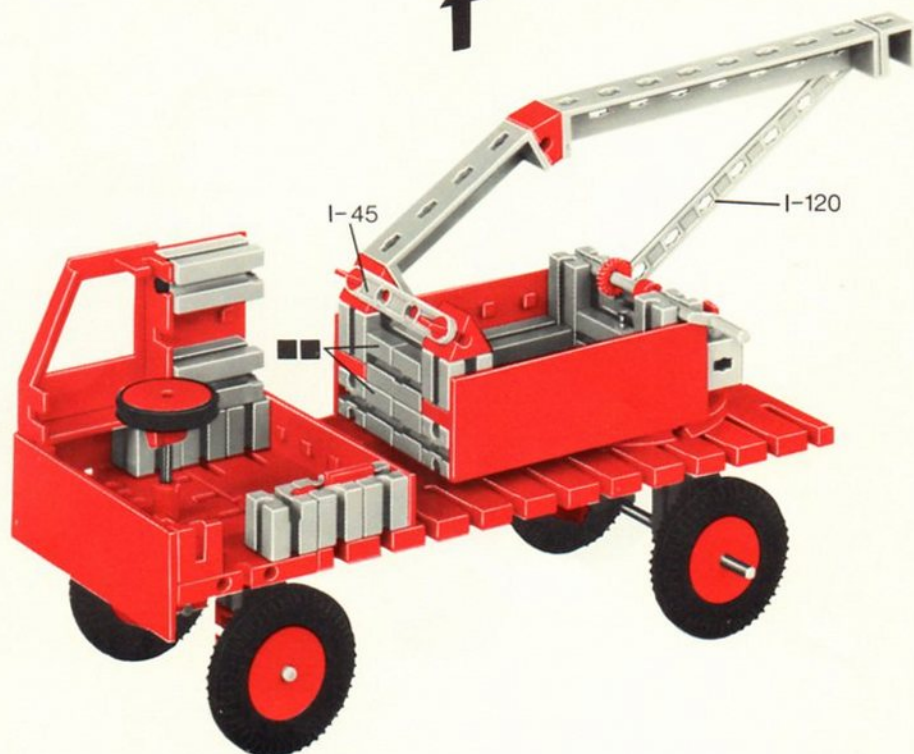
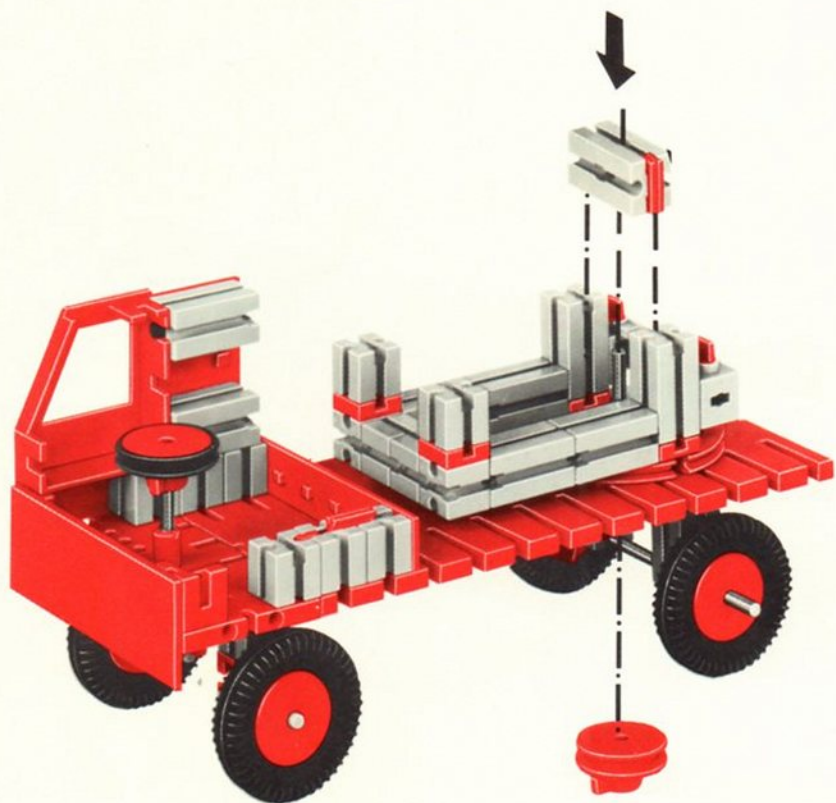







# Statik 1 + 200



Feuerwehr  
Fire engine  
Autopompe  
Brandweer

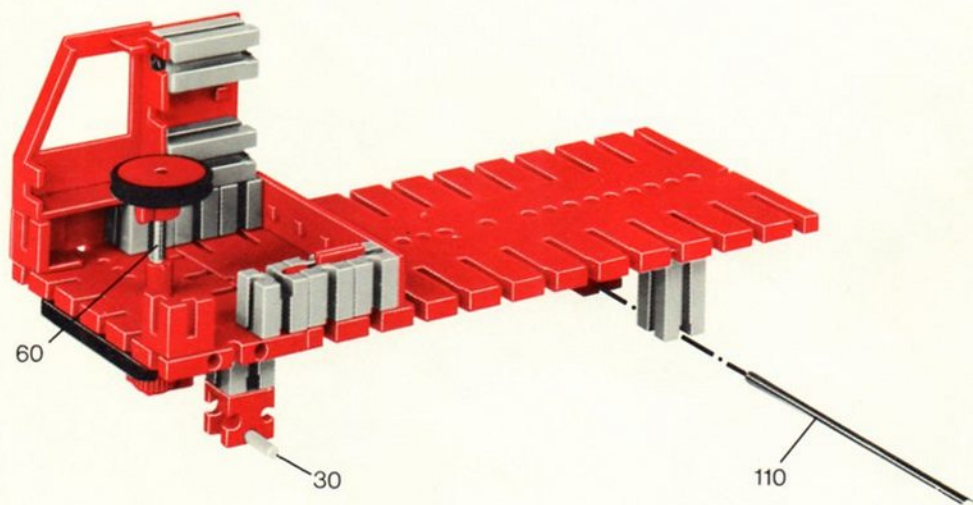
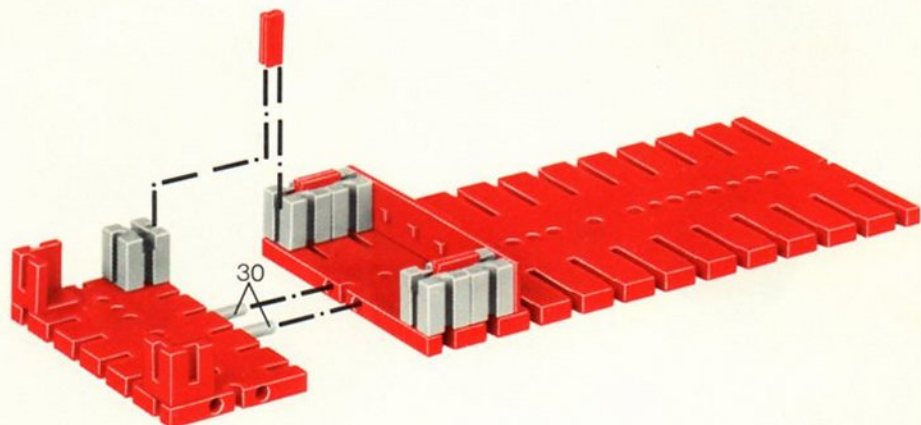

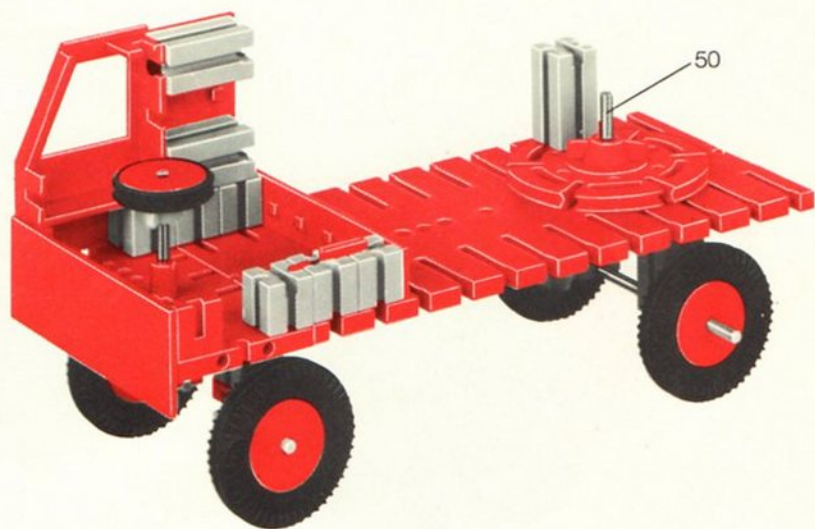
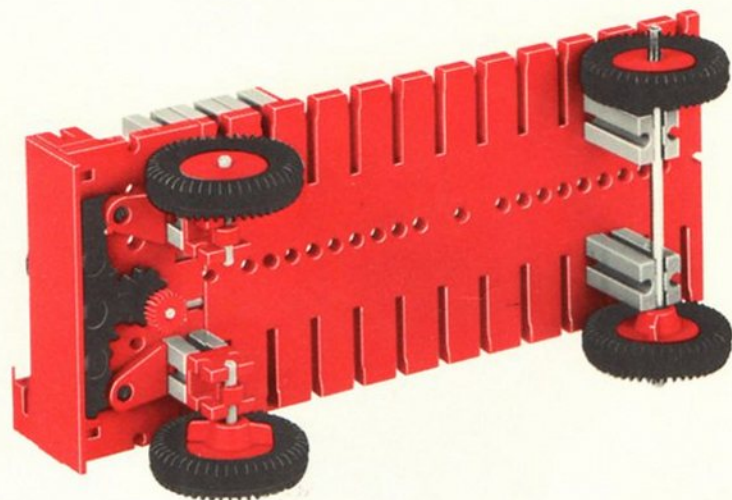





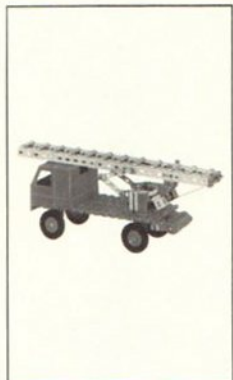



## Statik 1 + 300

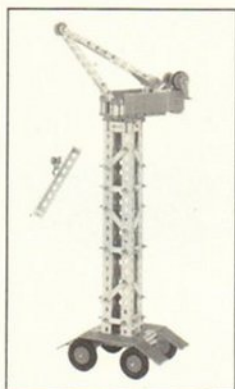

Turmdrehkran  
Tower crane  
Grue pivotante  
Toren draaikraan

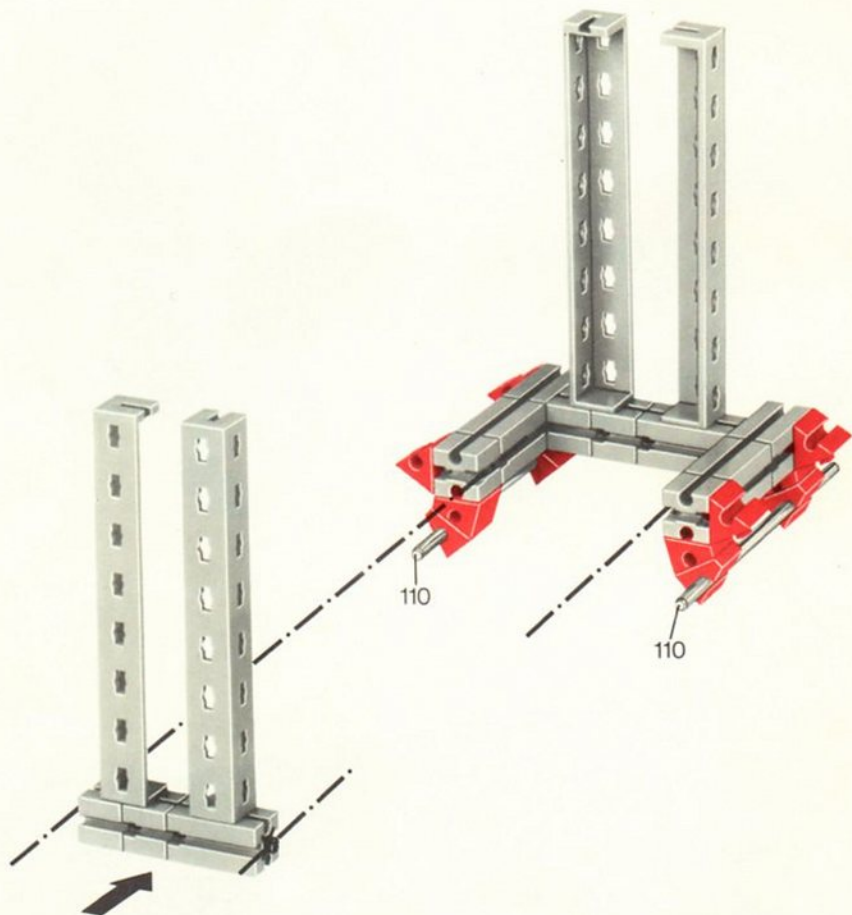

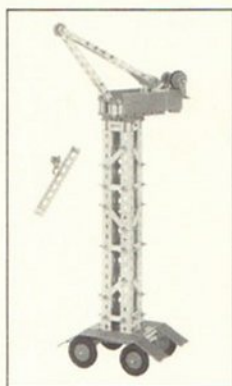
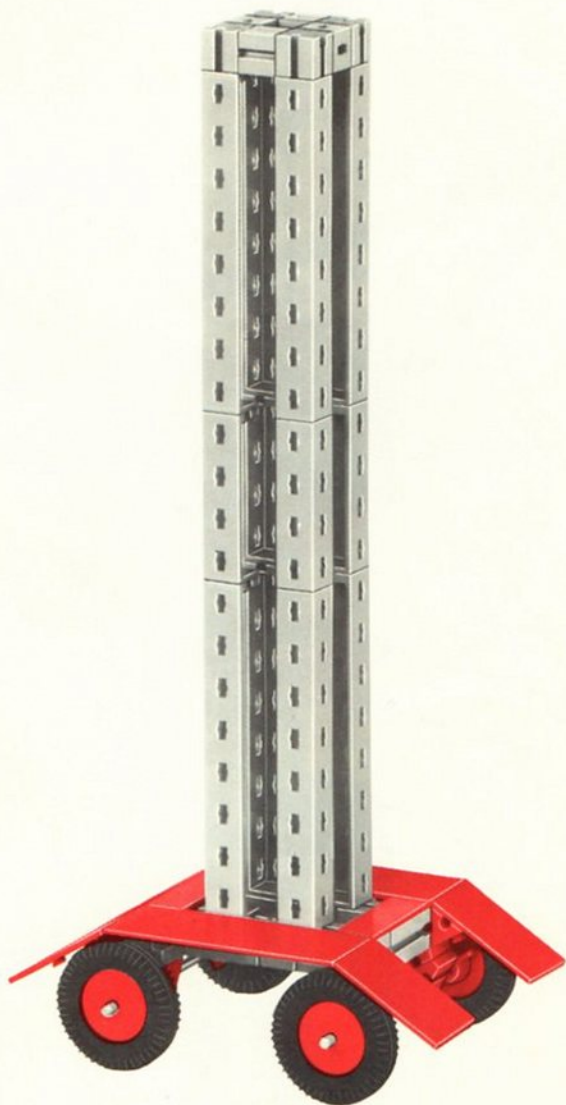

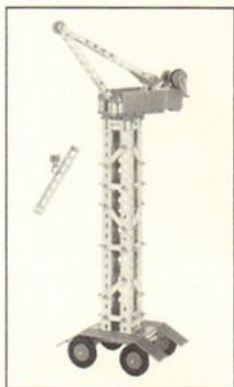
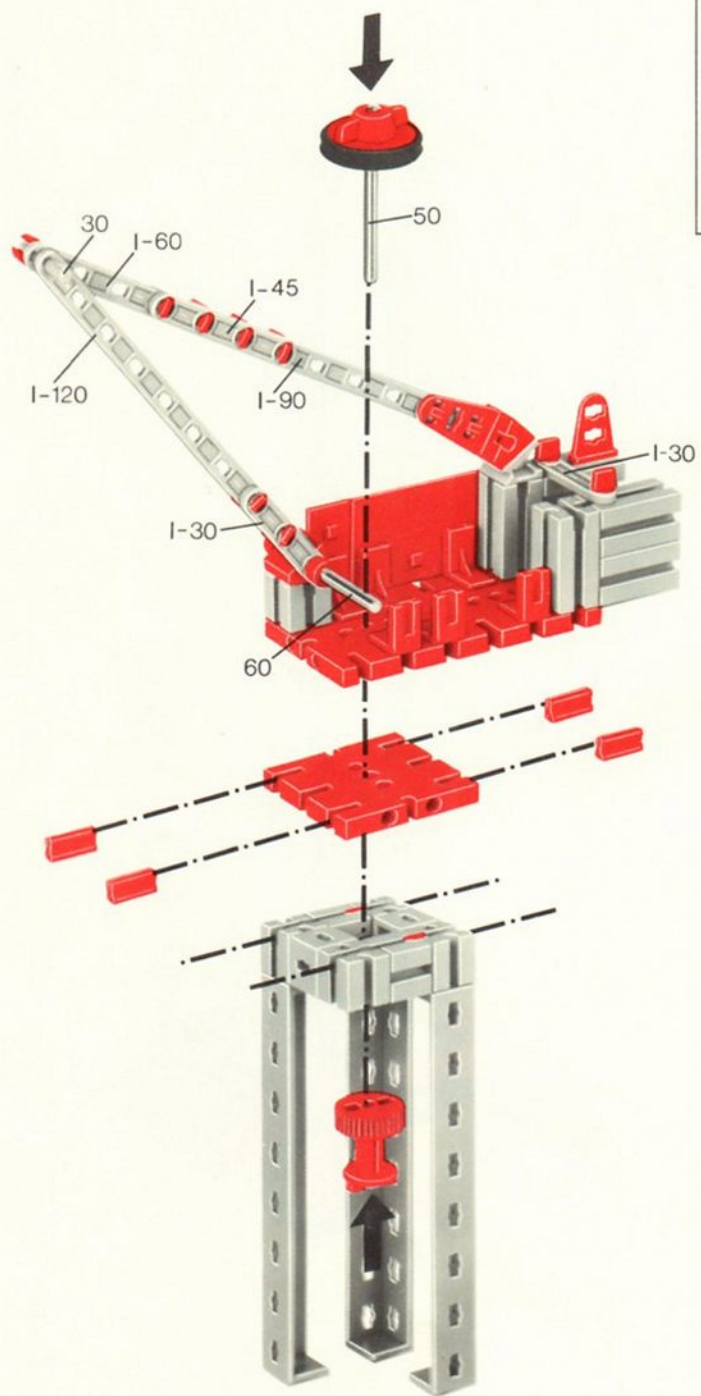

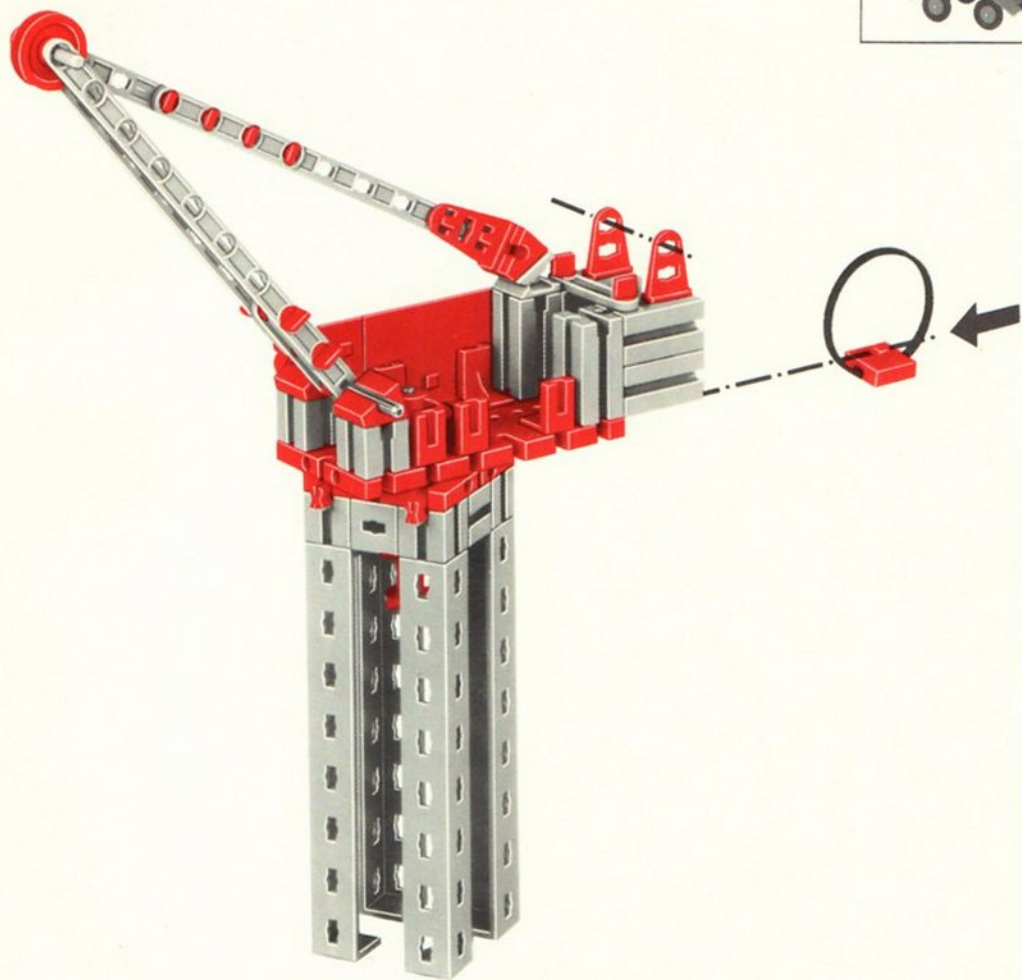
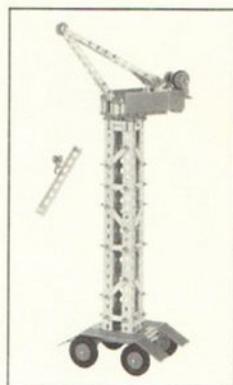



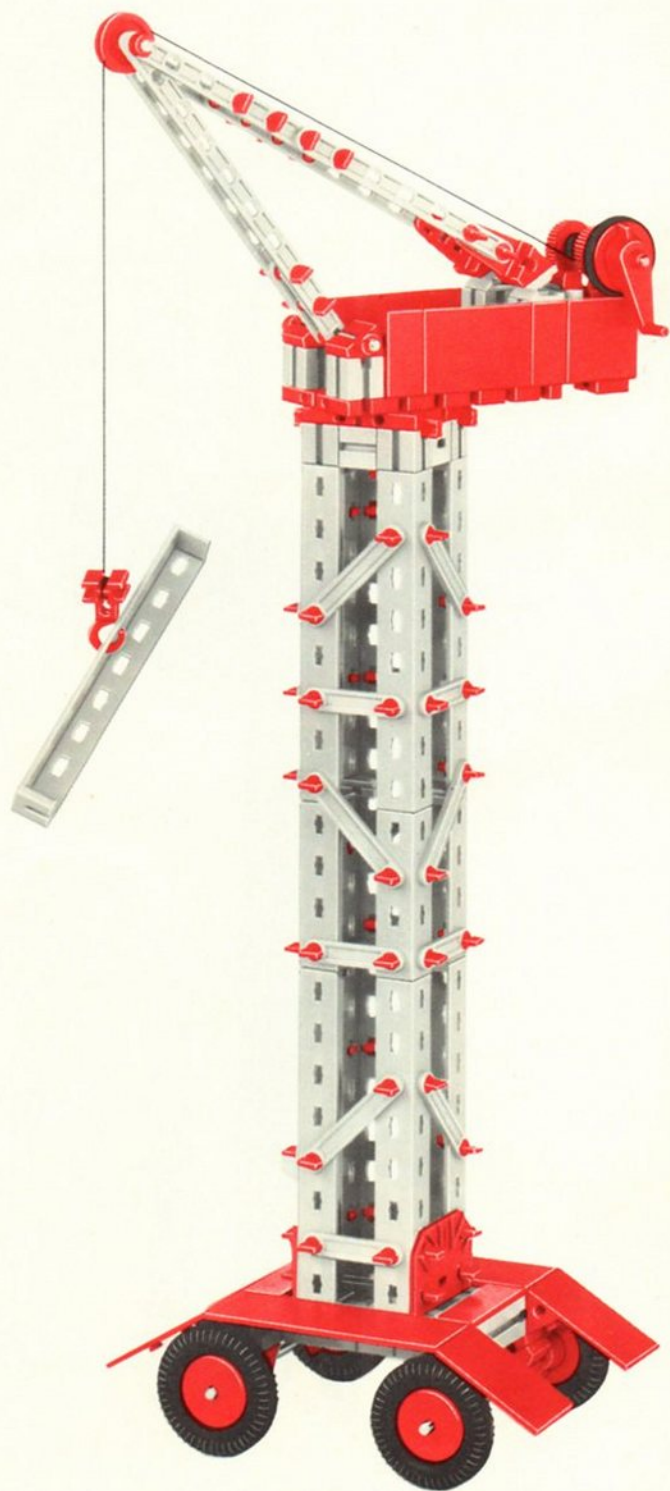

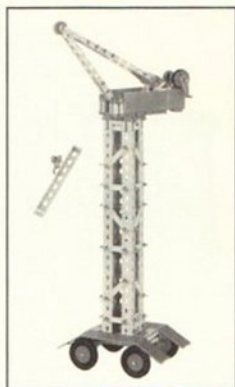
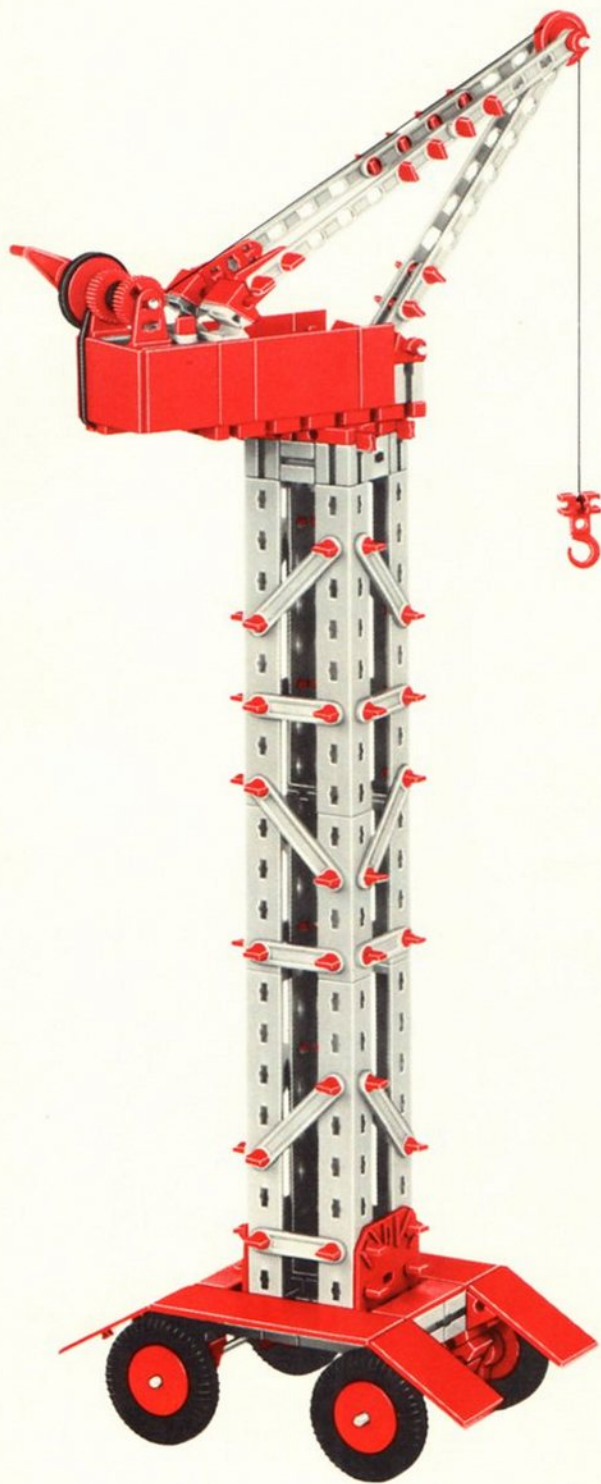

## Statik 1 + 300



Lagerplatzkran  
Parts lift and trans-  
porter crane  
Plateau de  
stockixage grue  
Pakhuistransport

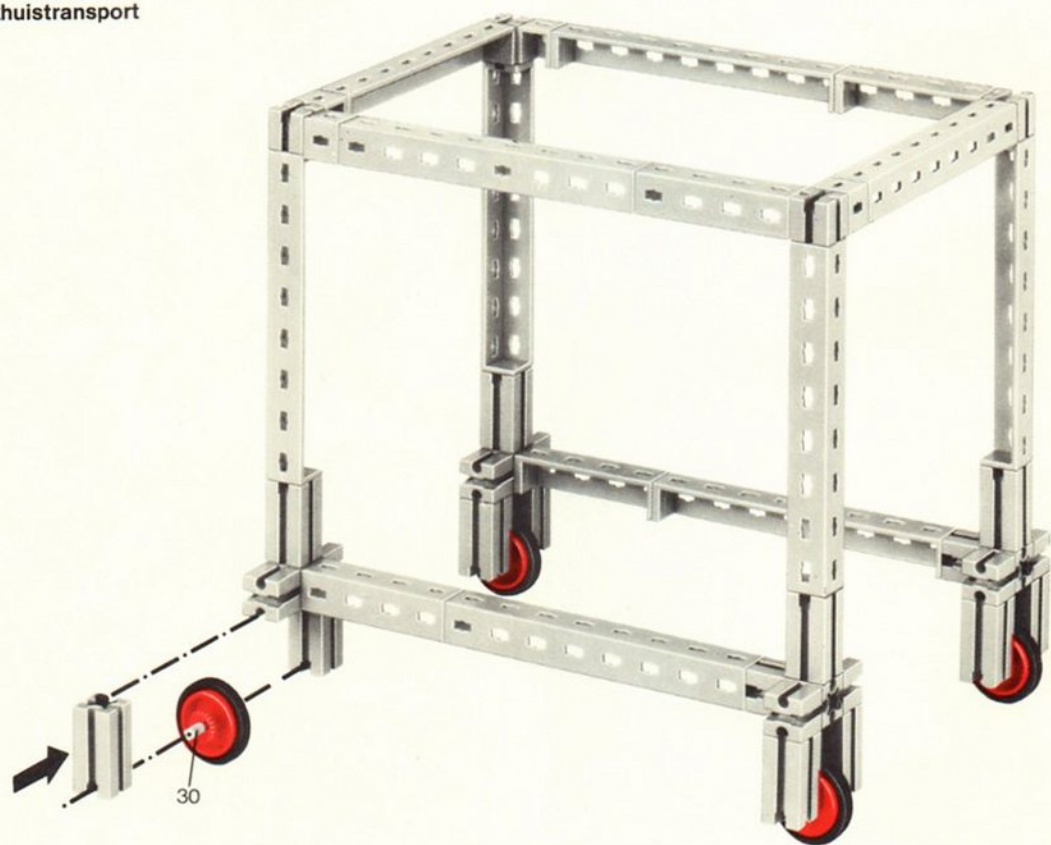

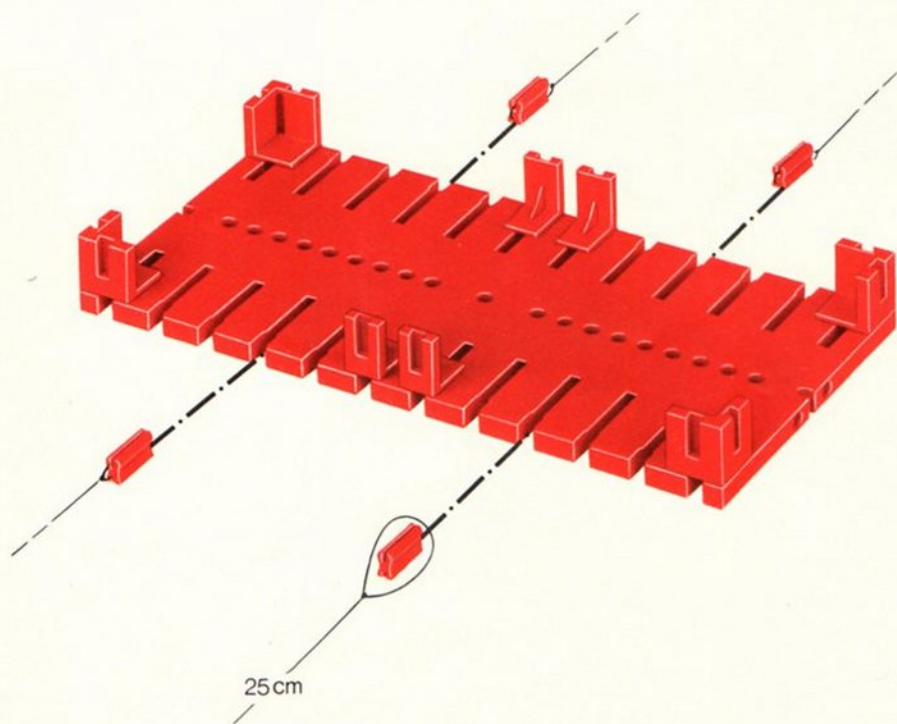
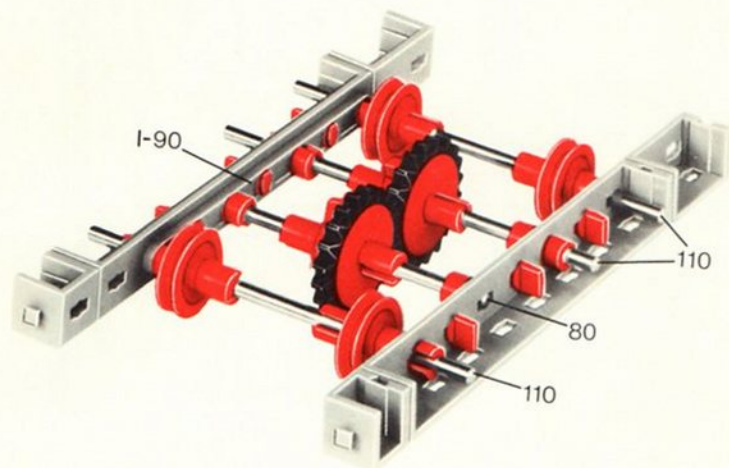



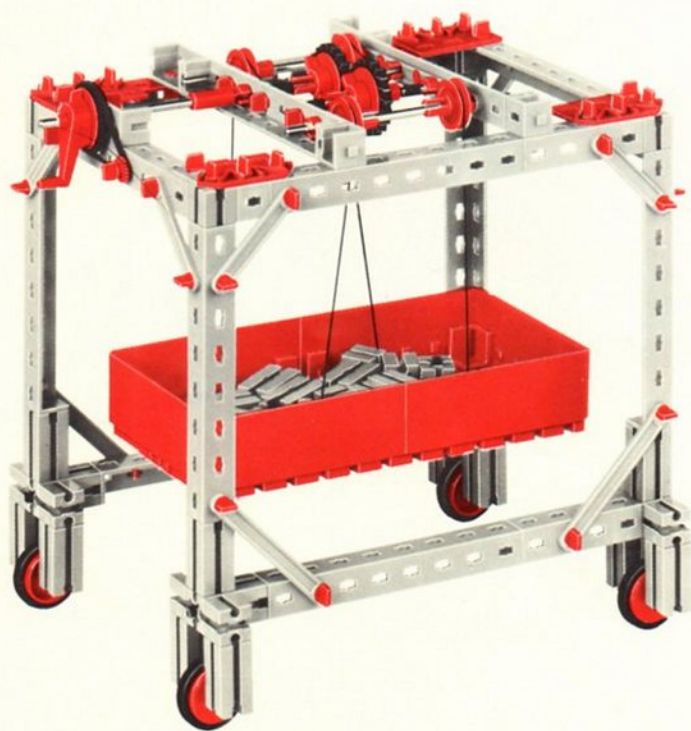
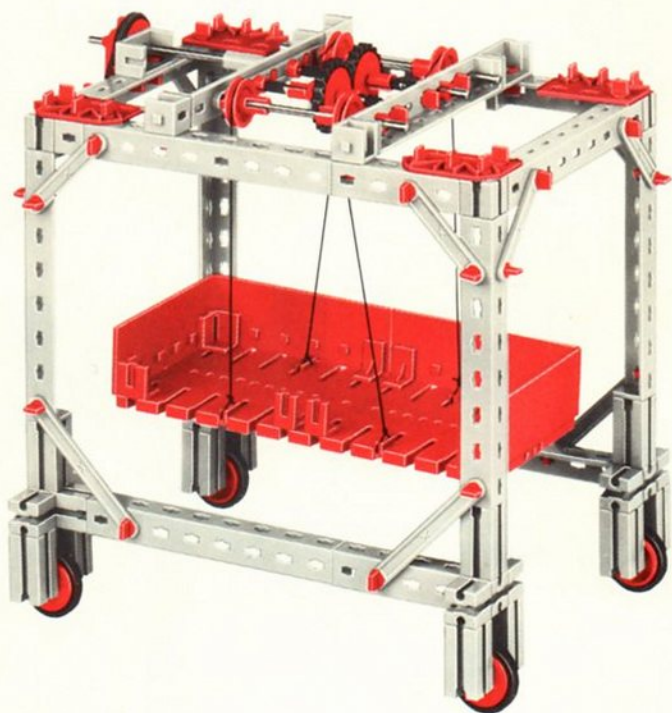























## Stückliste · Parts List · Nomenclature · Onderdelenlijst

	12 Winkelträger 120 · Angle girder 120 · Cornière de 120 · Hoekdraagsteun 120 4 36303 1		2 Lasche 15 · Connecting strip 15 · Eclisse de 15 · Rechtverbinding 15 4 36326 1
	4 Winkelträger 60 · Angle girder 60 · Cornière de 60 · Hoekdraagsteun 60 4 36302 1		2 Lasche 21,3 · Connecting strip 21,3 · Eclisse de 21,3 · Rechtverbinding 21,3 4 36327 1
	4 Winkelträger 30 · Angle girder 30 · Cornière de 30 · Hoekdraagsteun 30 4 36301 1		4 Doppelknotenplatte · Double gusset plate · Gousset · Dubbele hoekverbinding 4 35797 1
	2 Winkelträger 15 · Angle girder 15 · Cornière de 15 · Hoekdraagsteun 15 4 36300 1		70 S-Riegel 4 · Single rivet 4 mm · Rivet de 4 mm · S-grendel 4 mm 4 36323 1
	4 Winkelträger 15 mit 2 Zapfen · Angle girder 15 with two pins · Cornière de 15 à 2 tenons · Hoekdraagsteun 15 met 2 nokken 4 36304 1		15 S-Riegel 6 · Double rivet 6 mm · Rivet de 6 mm · S-grendel 6 mm 4 36324 1
	4 Scharnier · Hinge · Charnière · Scharnier 4 36329 1		4 S-Riegel 8 · Triple rivet 8 mm · Rivet de 8 mm · S-grendel 8 mm 4 36457 1
	12 Strebe 30 · I-strut 30 · Entretoise type I de 30 · I-spant 30 4 36309 1		15 Riegelscheibe · Locking washer · Disque d'arrêt · Grendelschijf 4 36334 1
	4 Strebe 45 · I-strut 45 · Entretoise type I de 45 · I-spant 45 4 36310 1		1 Nylonseil · Nylon cord · Filin Nylon · Nylon snoer 3 31027 1
	2 Strebe 45 mit Loch · I-strut 45 with holes · Entretoise type I à perf. mult. de 45 · I-spant 45 met gat 4 38536 1		1 S-Griff · Rivet holder · Tourne-rivet · S-greep 4 35800 1
	2 Strebe 60 mit Loch · I-strut 60 with holes · Entretoise type I à perf. mult. de 60 · I-spant 60 met gat 4 38535 1		1 Kassetten-Unterteil · Cassette, bottom · Coffret, partie inférieure · Cassette, onderstuk 4 35359 1
	12 Strebe 42,4 · X-strut 42,4 · Entretoise type X de 42,4 · X-spant 42,4 4 36315 1		1 Kassetten-Deckel · Cassette, top · Coffret, partie supérieure · Cassette, deksel 4 35360 1
	4 Strebe 63,6 · X-strut 63,6 · Entretoise type X de 63,6 · X-spant 63,6 4 36316 1		



# Statik 1 + Statik 2 + 100

Modell aus Statik 2  
Model out of Statik 2  
Modèl realisé à  
Statik 2  
Modell uit Statik 2

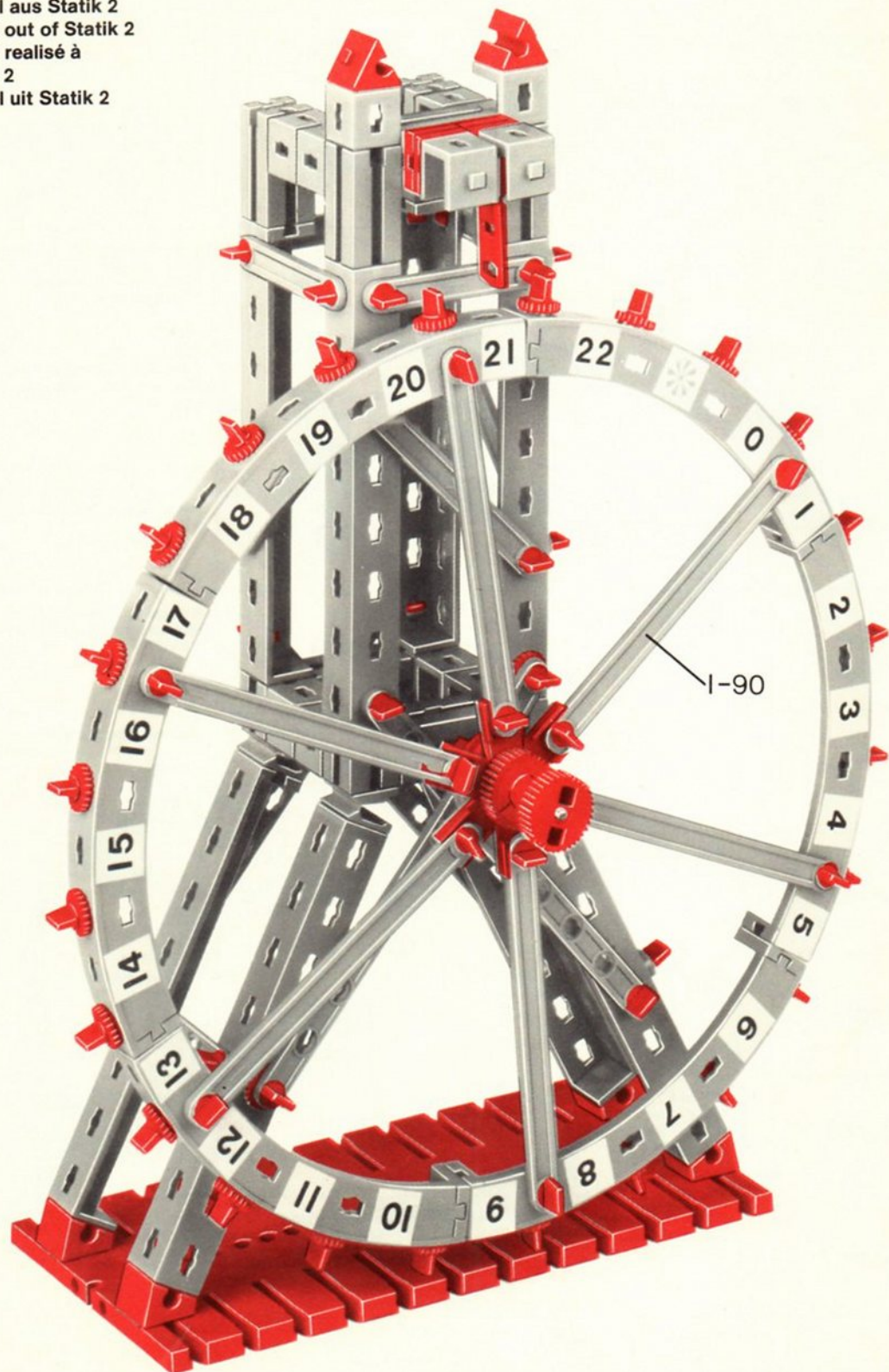

Statik 1 + Statik 2 + Statik 3 + 50

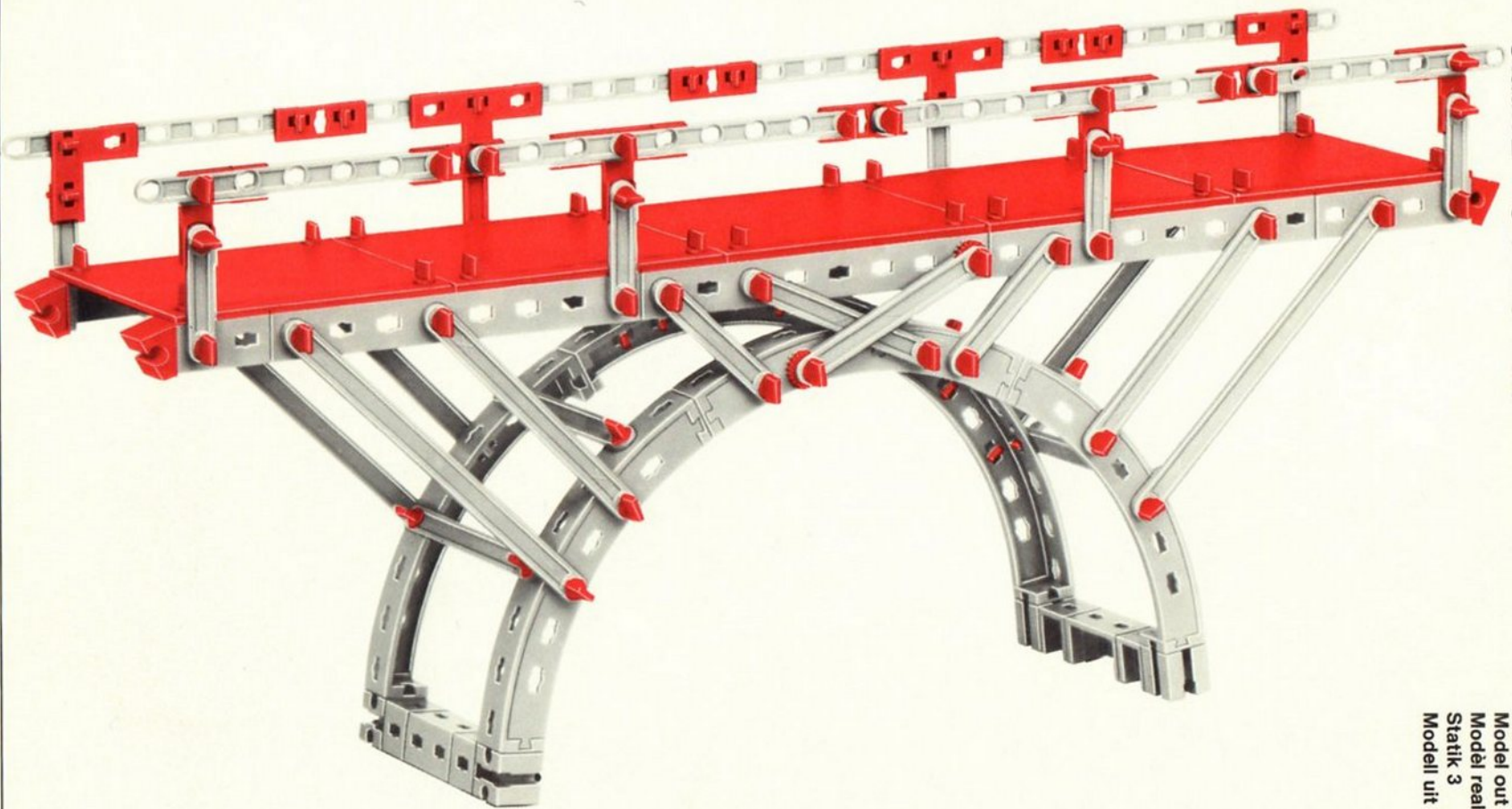

Modell aus Statik 3  
Modell out of Statik 3  
Modell réalisé à  
Statik 3  
Modell uit Statik 3



Modelle aus dem fischertechnik  
Elektromechanik Baukasten em 1  
Models built using the fischertechnik  
electro-mechanical construction kit  
Modèles réalisés à partir de la  
boîte d'électromécanique  
Modellen uit de fischertechnik  
elektromechanika bouwdoos

