

fischer[®]technik

Ergänzung zu den Grundkästen

Statik 3

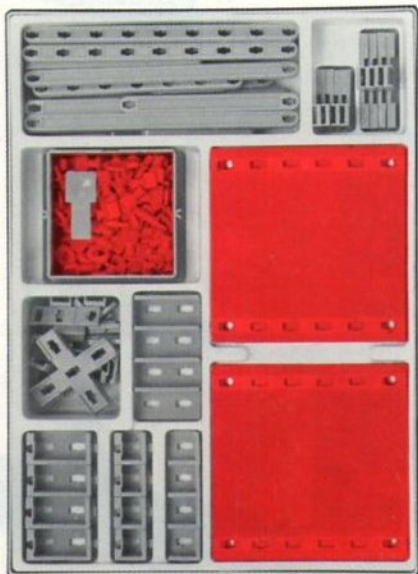

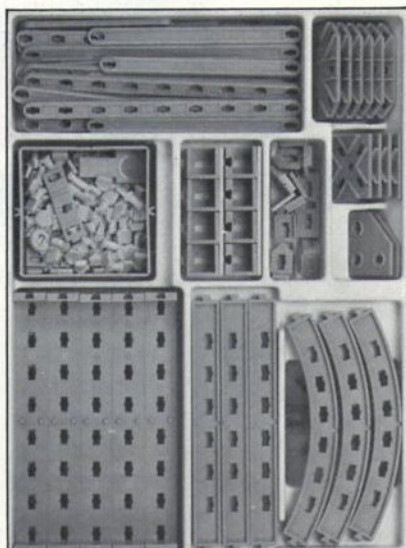
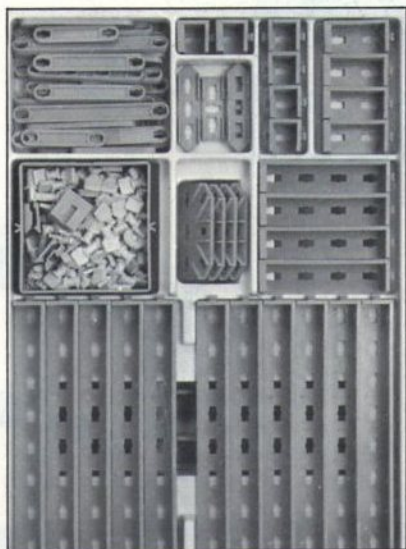
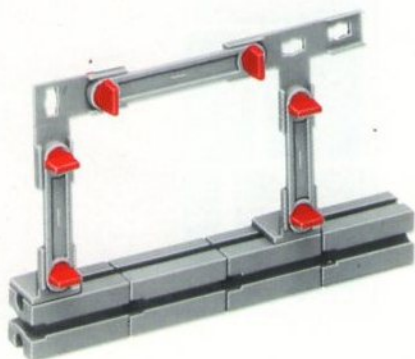
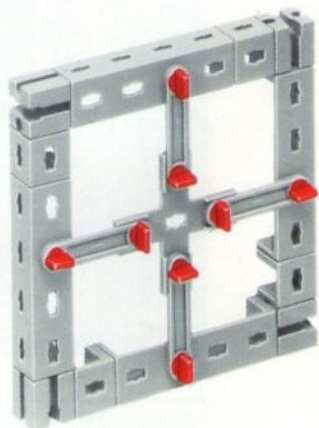
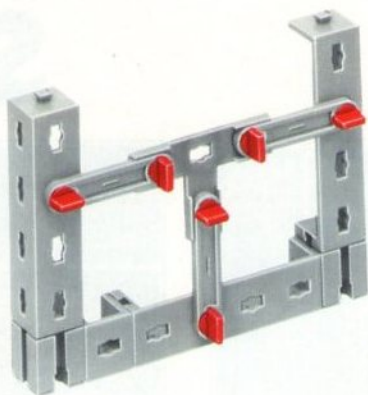
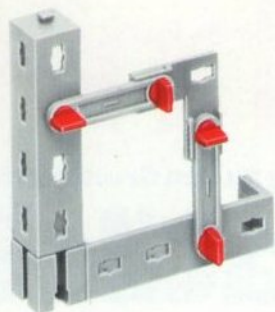

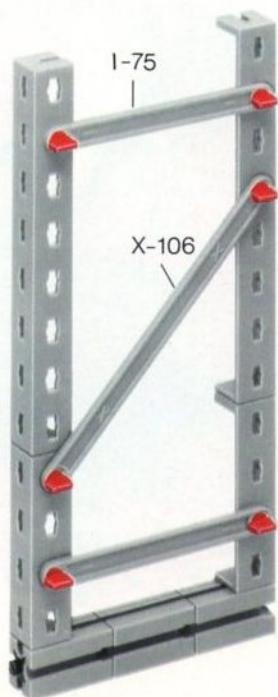
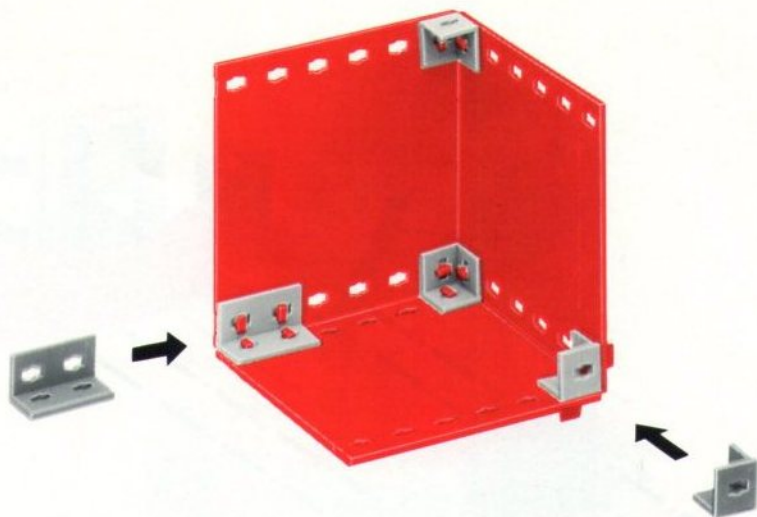

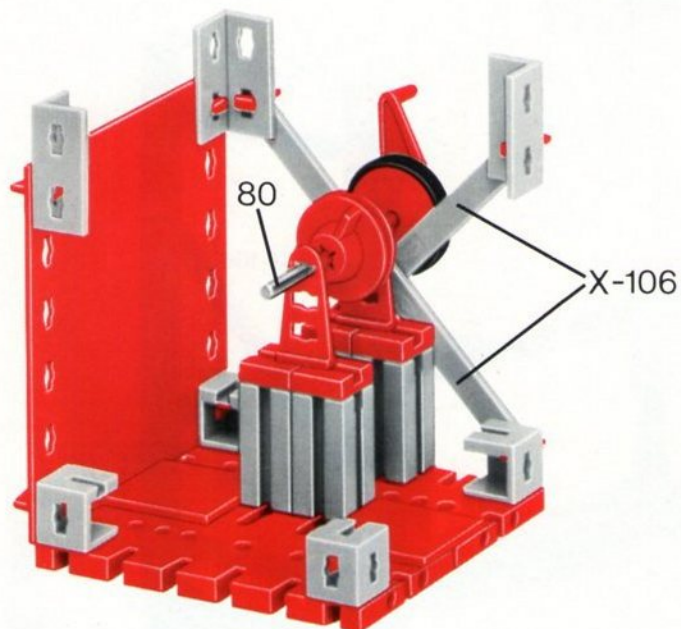
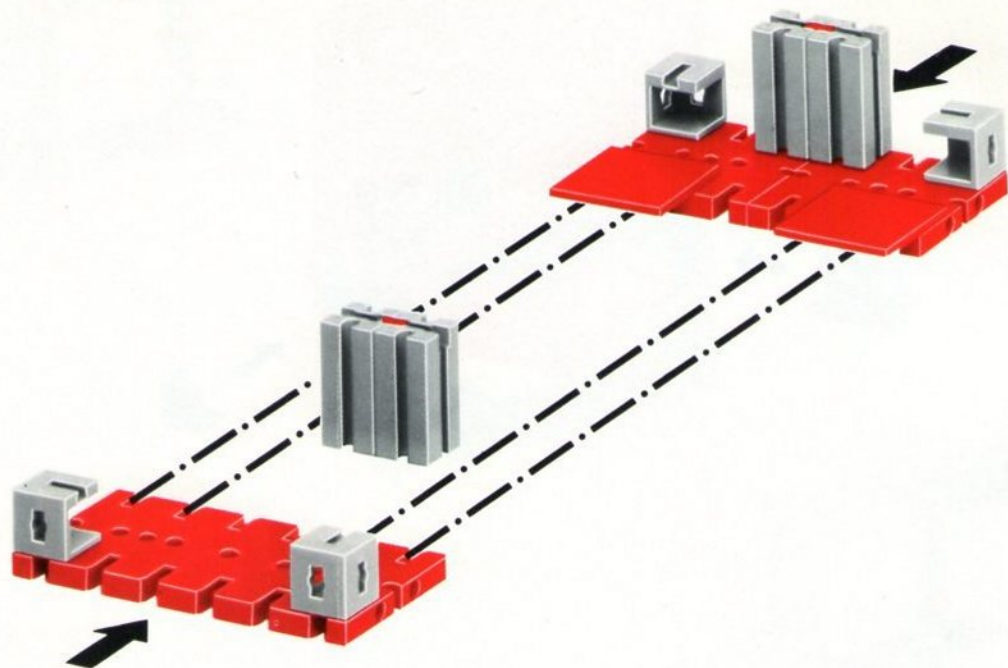

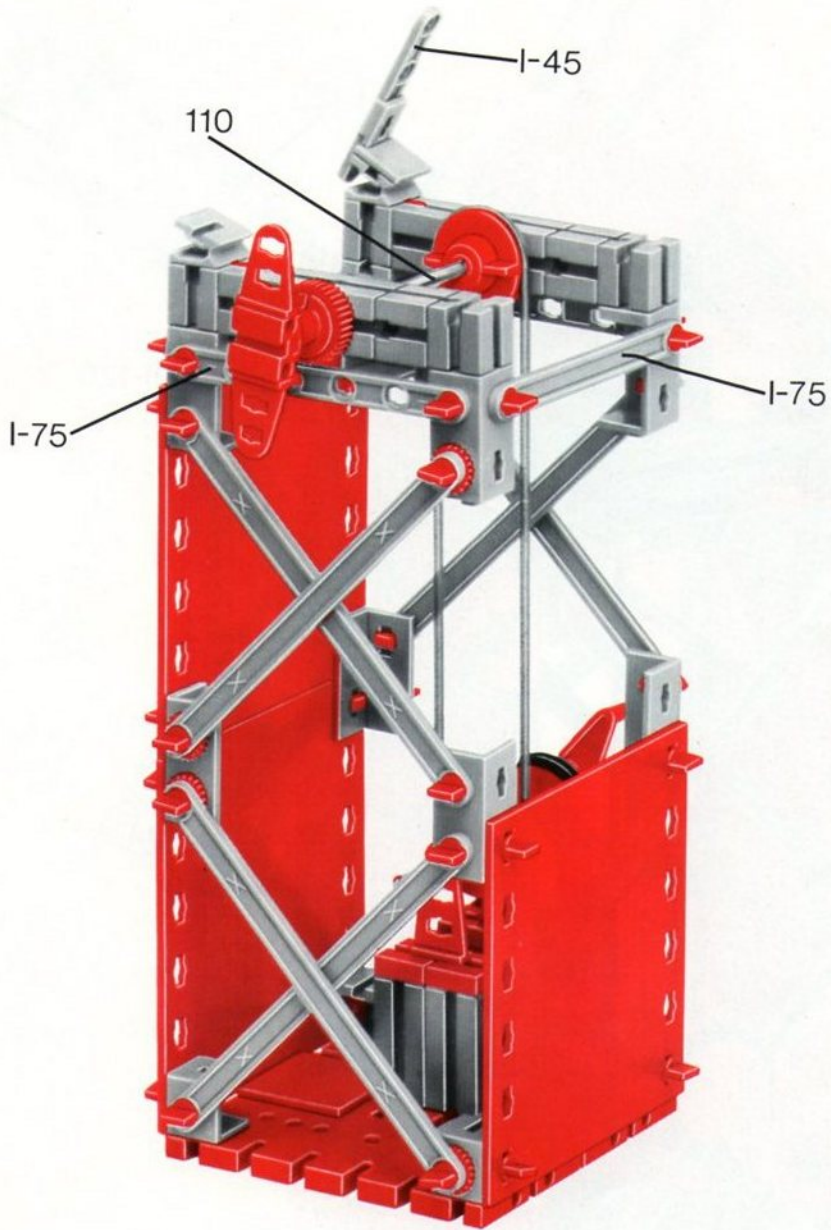

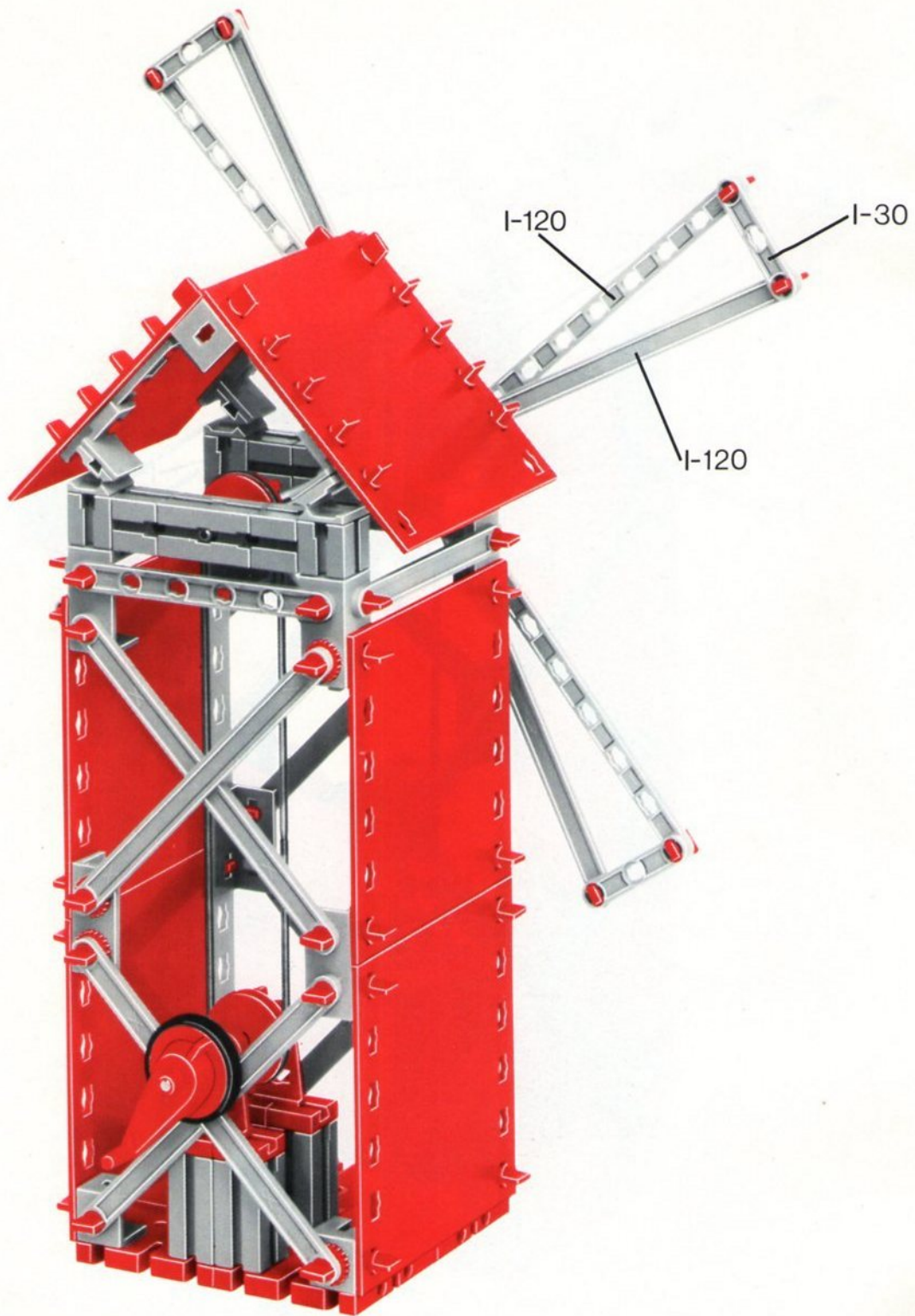

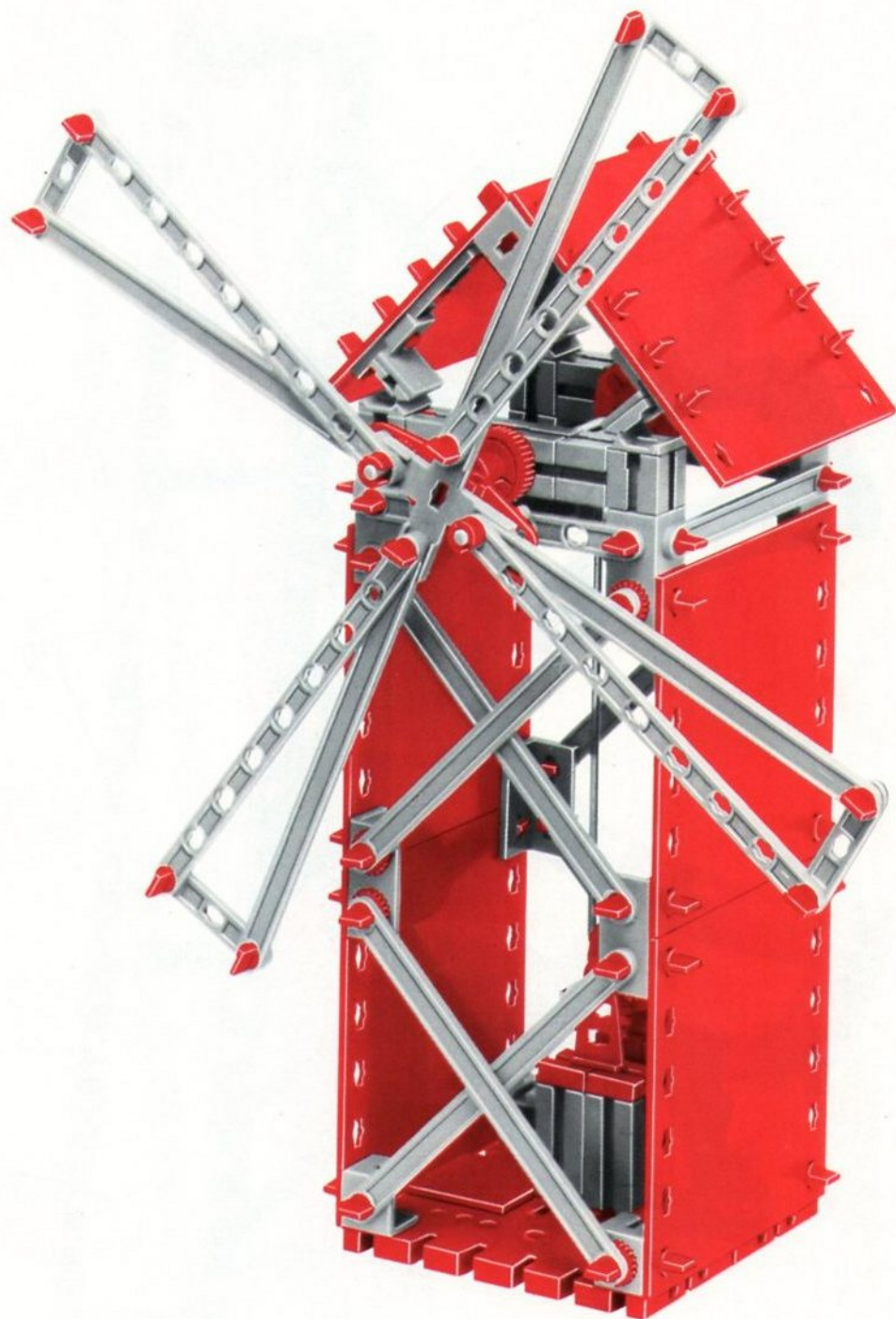

Statik 1 + Statik 2 + Statik 3 + 50

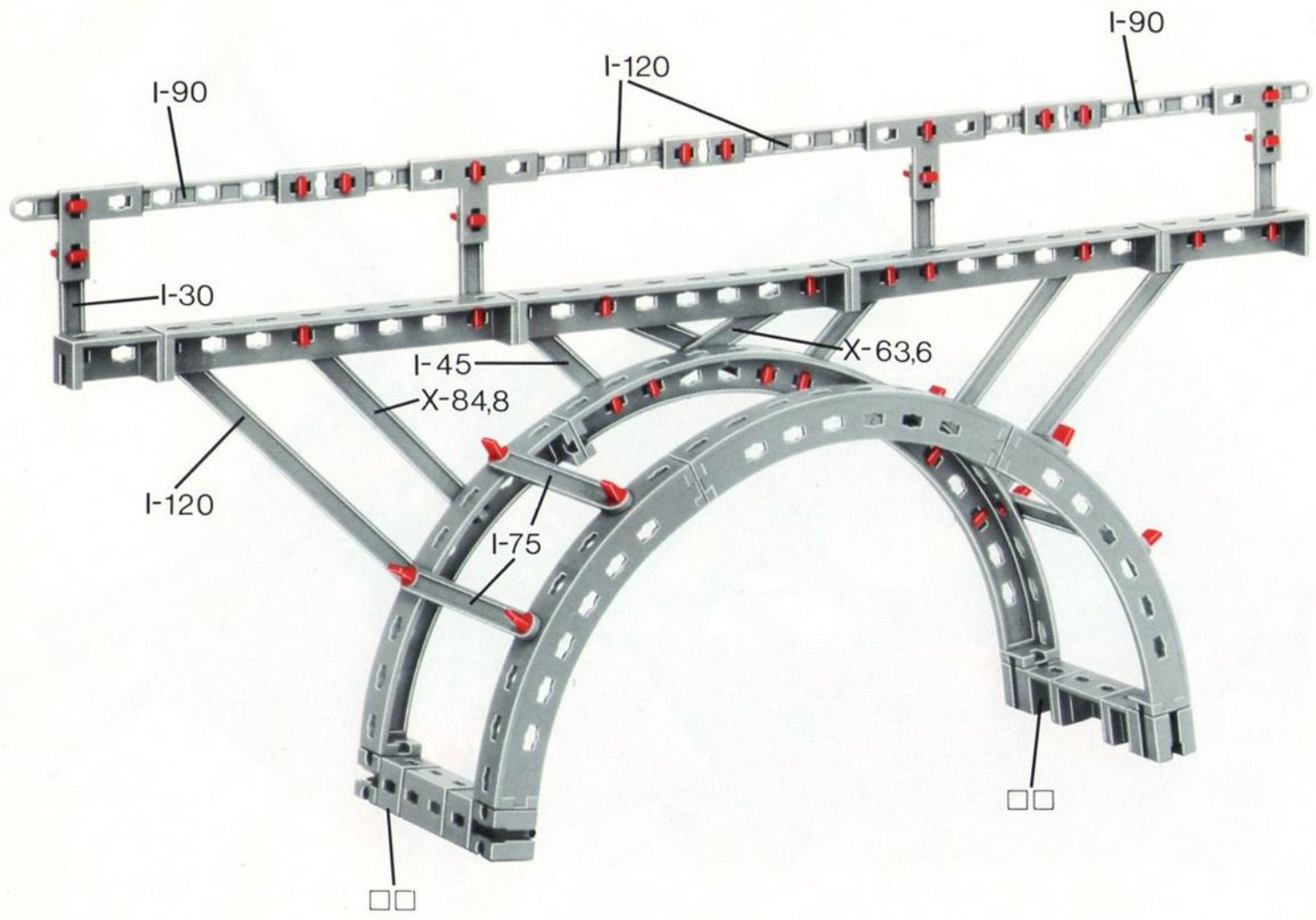



Statik 1 + Statik 2 + Statik 3 + 50

Statik 1 + Statik 2 + Statik 3 + 100

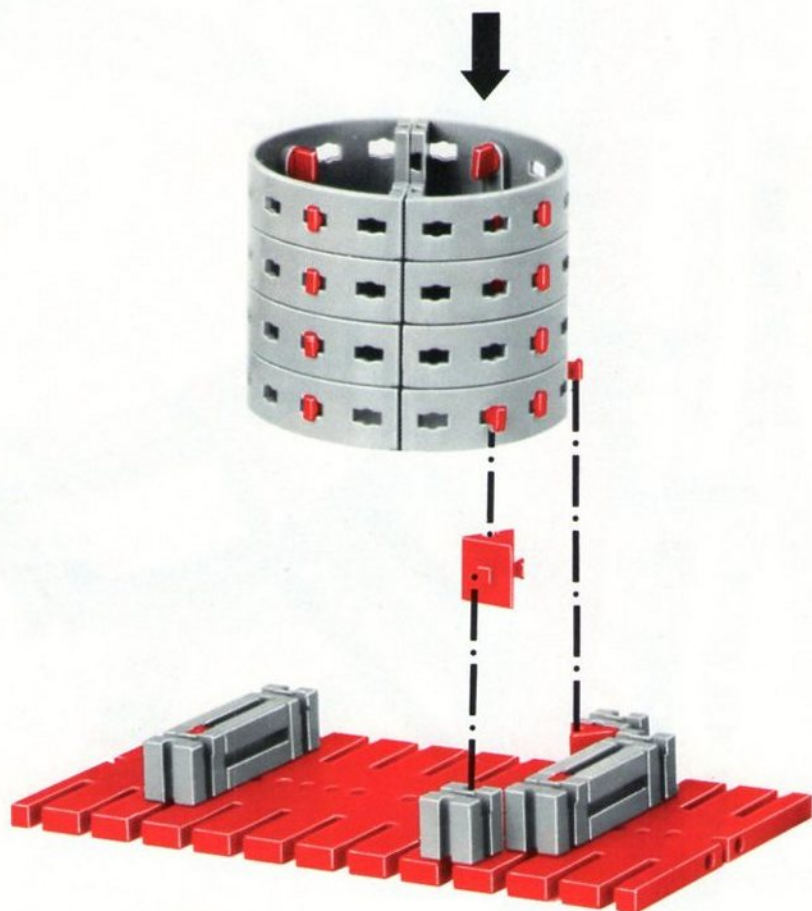
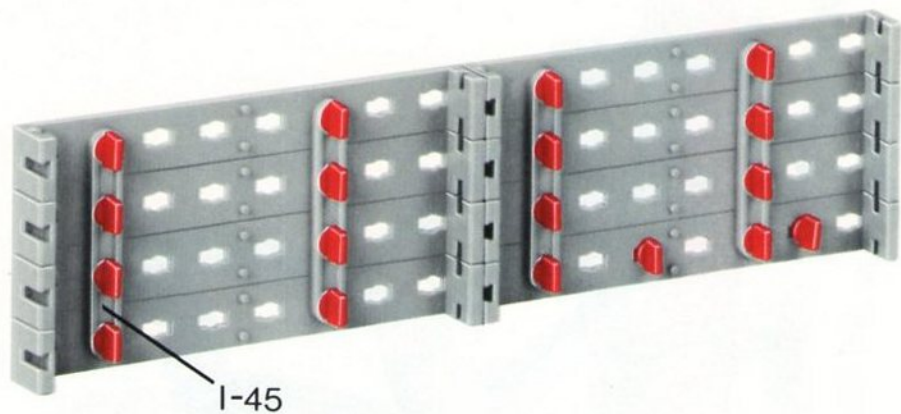

Statik 1 + Statik 2 + Statik 3 + 100

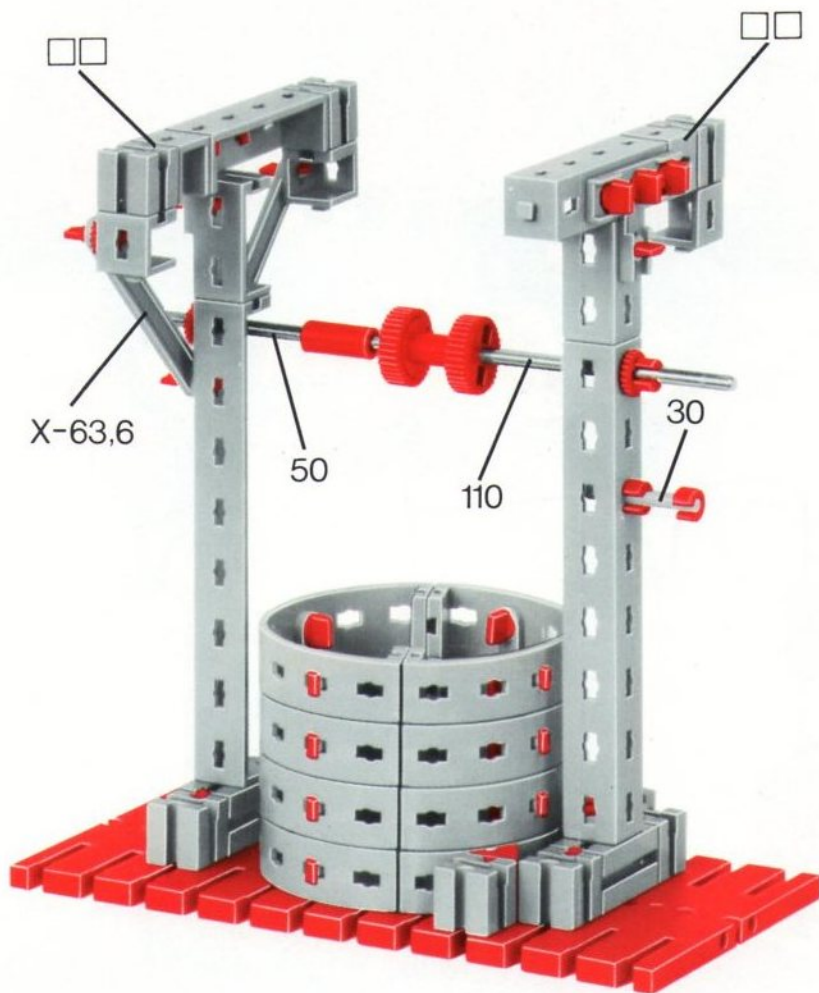

Statik 1 + Statik 2 + Statik 3 + 100

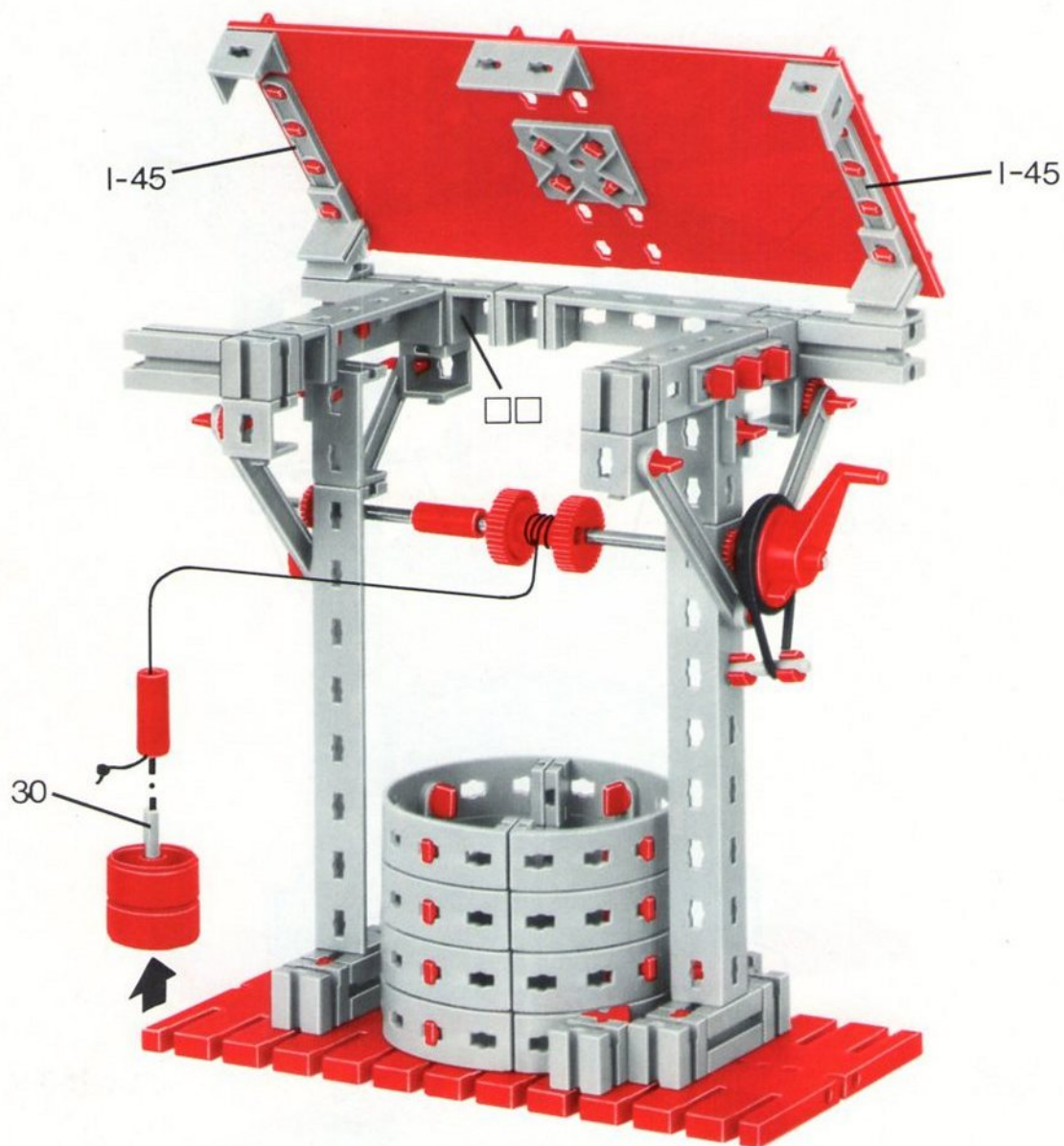

Statik 1 + Statik 2 + Statik 3 + 100



Statik 1 + Statik 2 + Statik 3 + 100

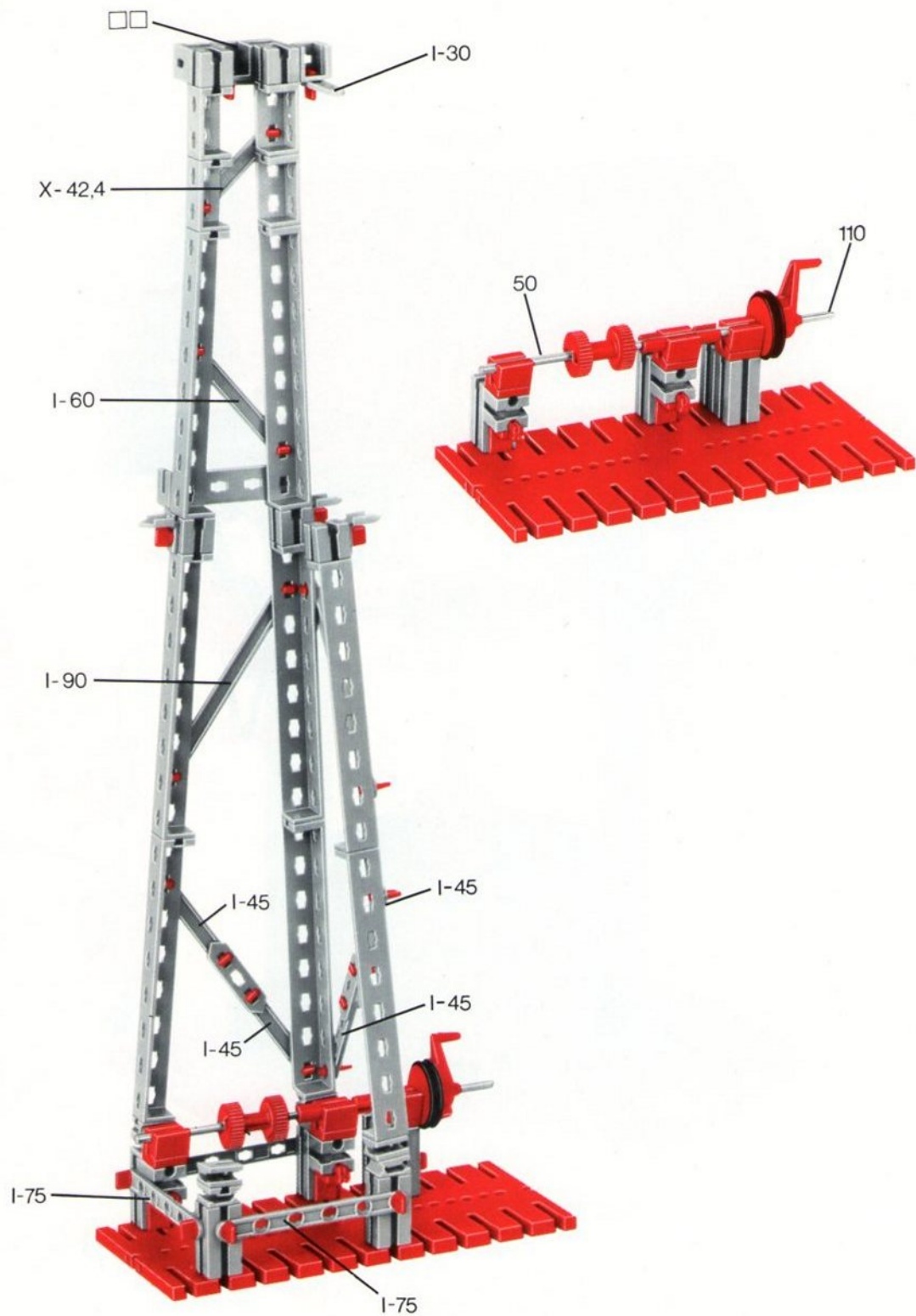

Statik 1 + Statik 2 + Statik 3 + 100

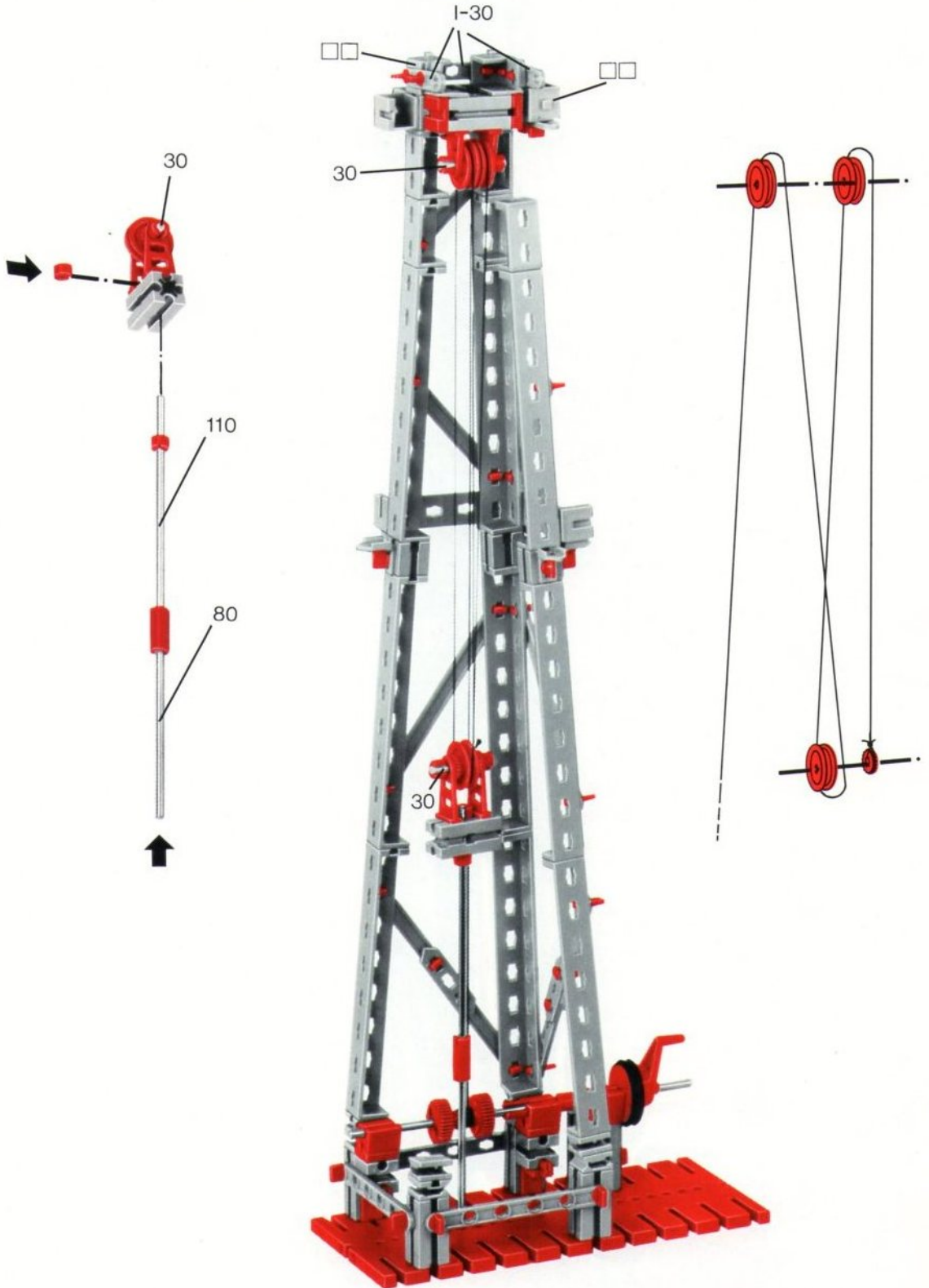

Statik 1 + Statik 2 + Statik 3 + 100

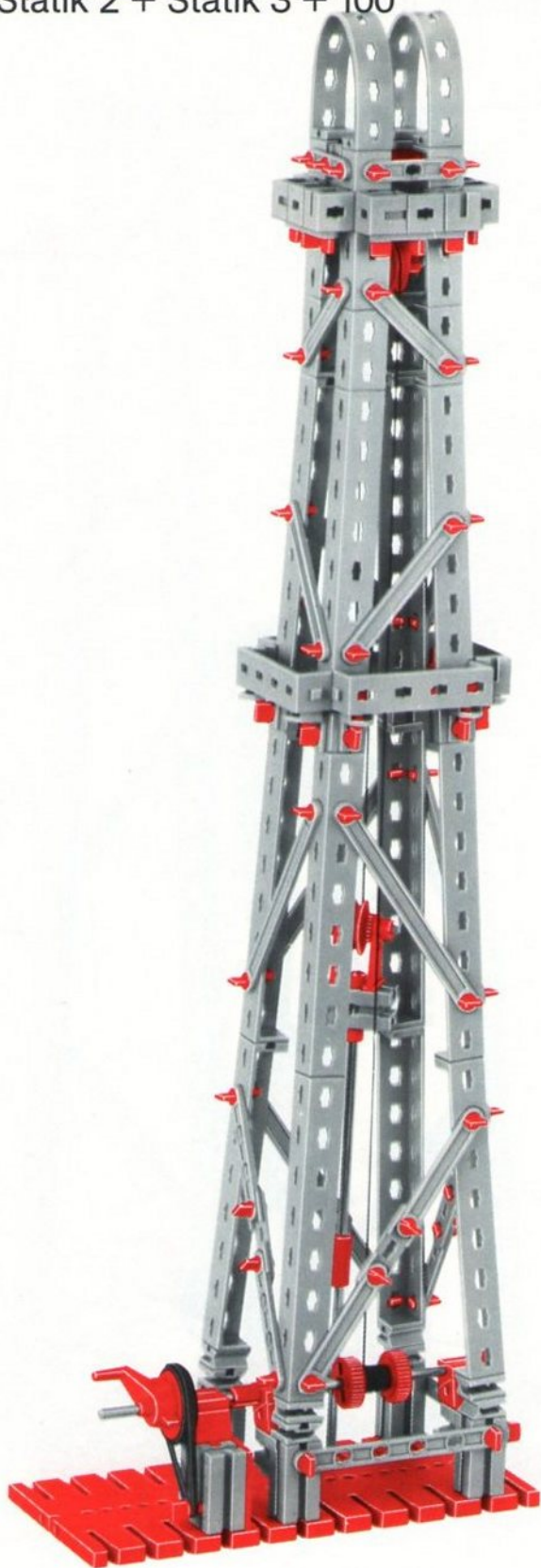

Statik 1 + Statik 2 + Statik 3 + 100

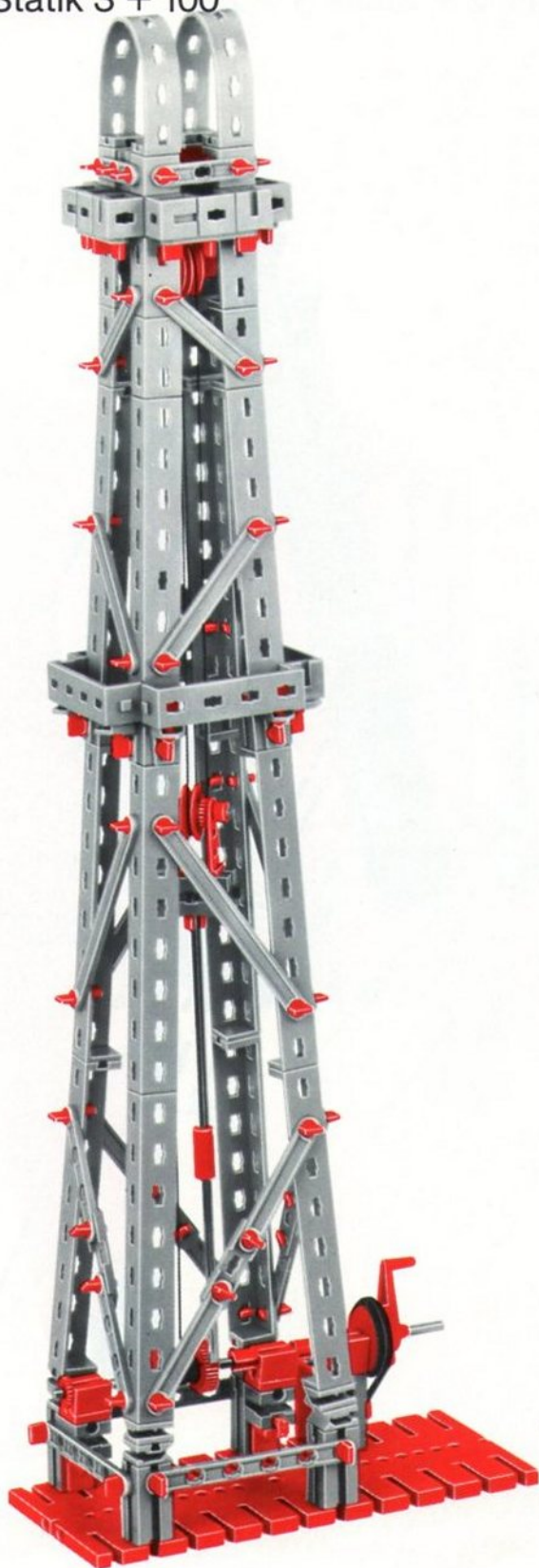

Statik 1 + Statik 2 + Statik 3 + 200

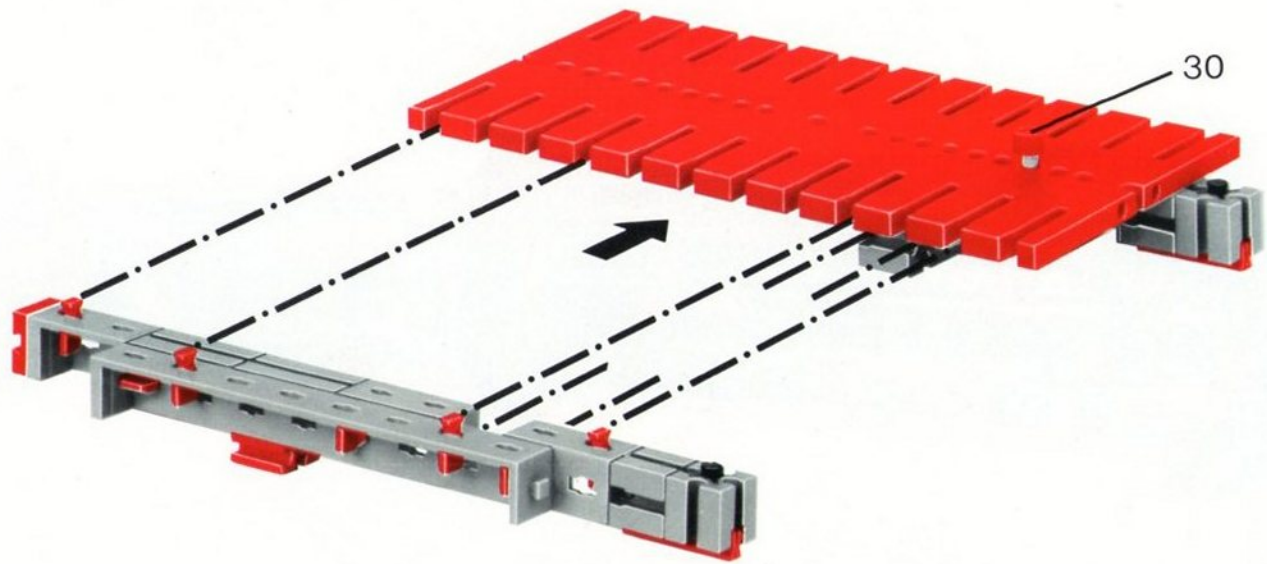

Statik 1 + Statik 2 + Statik 3 + 200

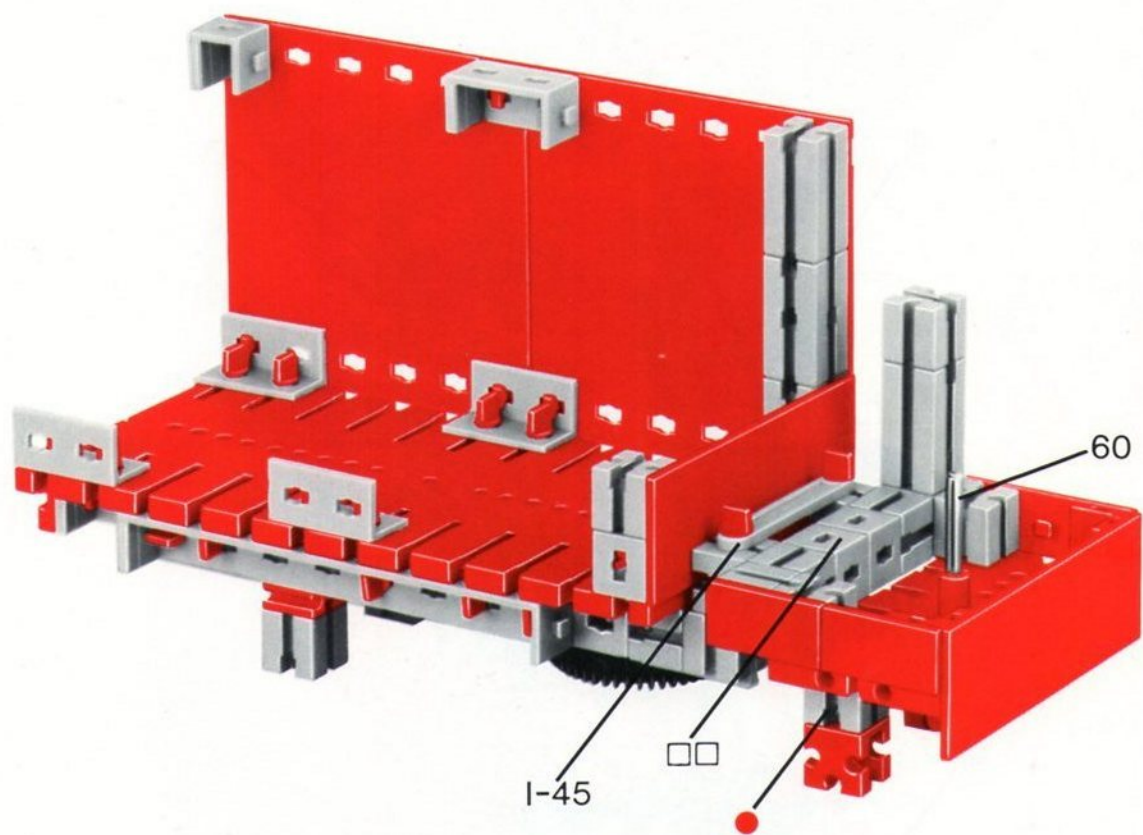

Statik 1 + Statik 2 + Statik 3 + 200

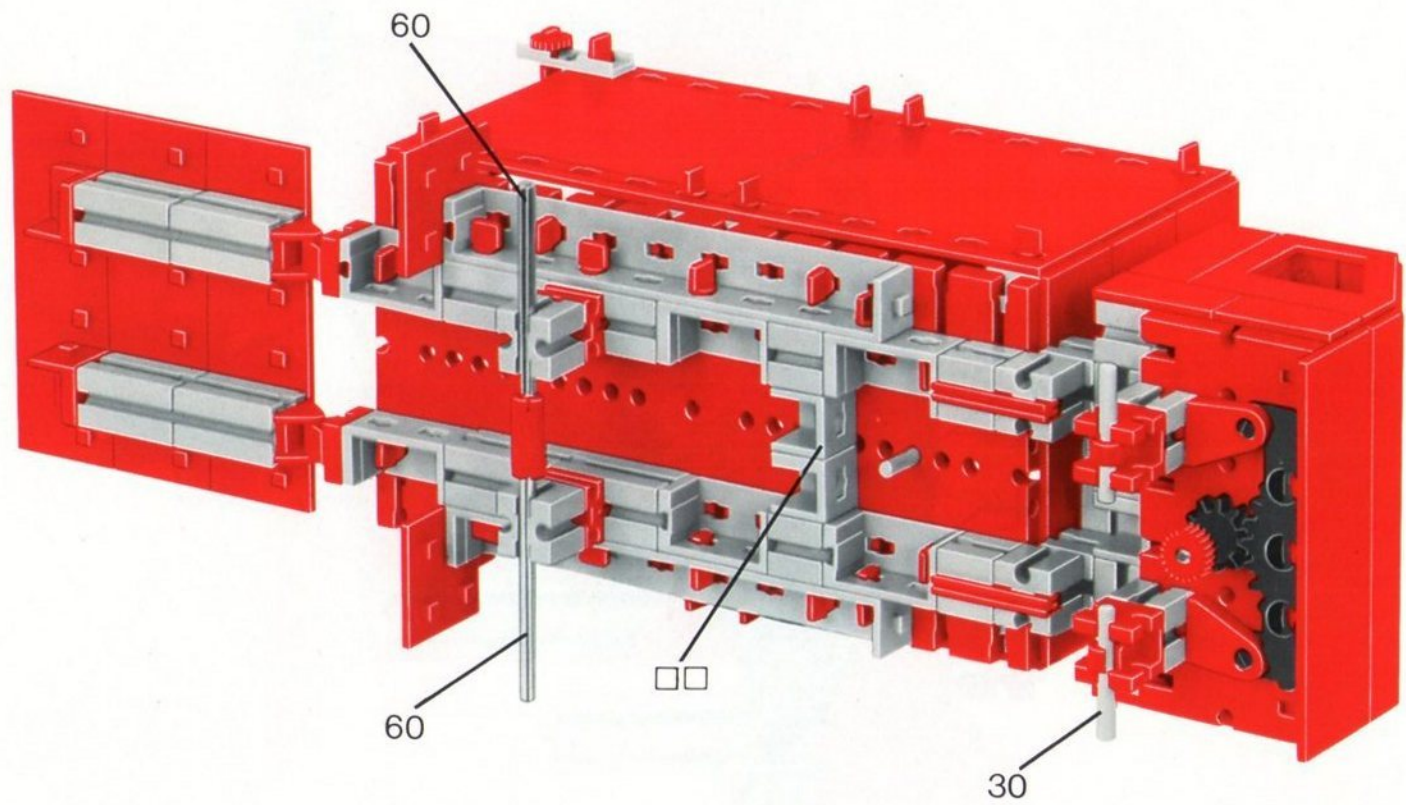



Statik 1 + Statik 2 + Statik 3 + 200

Statik 1 + Statik 2 + Statik 3 + 200



Statik 1 + Statik 2 + Statik 3 + 200

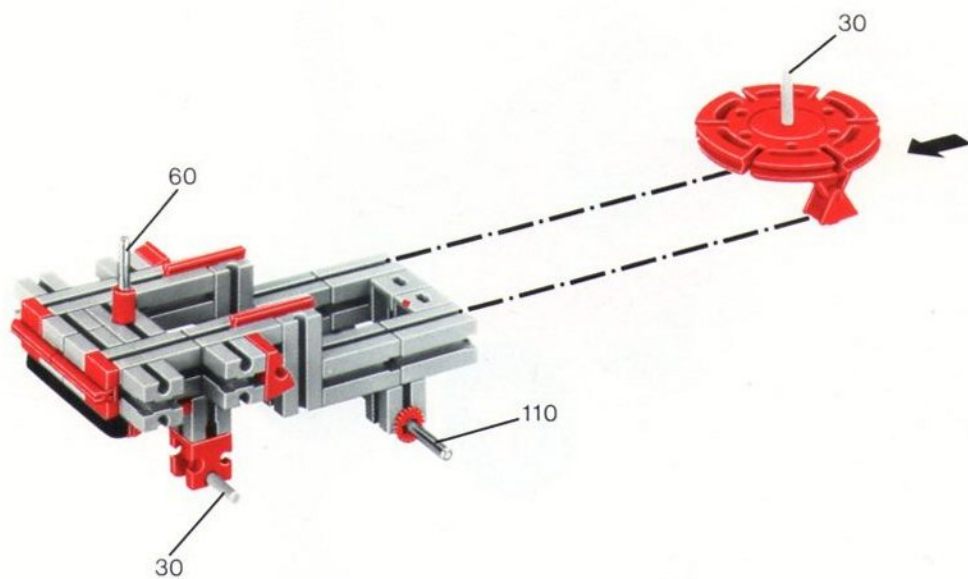
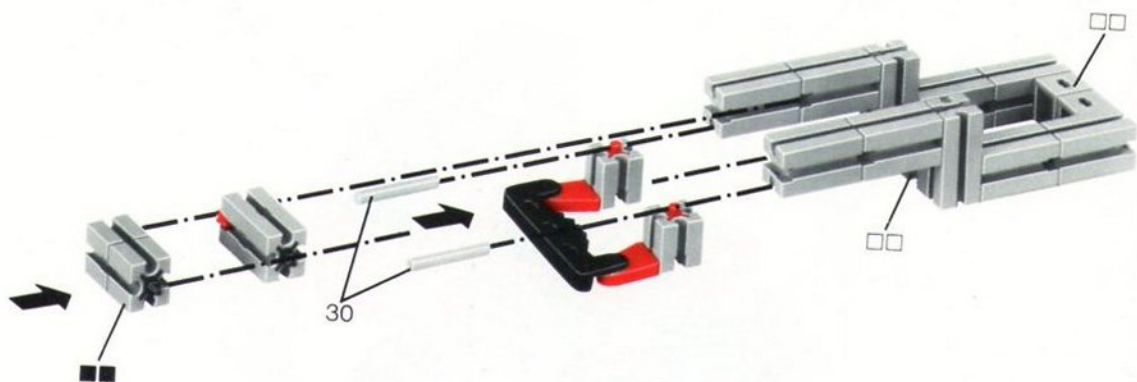

Statik 1 + Statik 2 + Statik 3 + 200



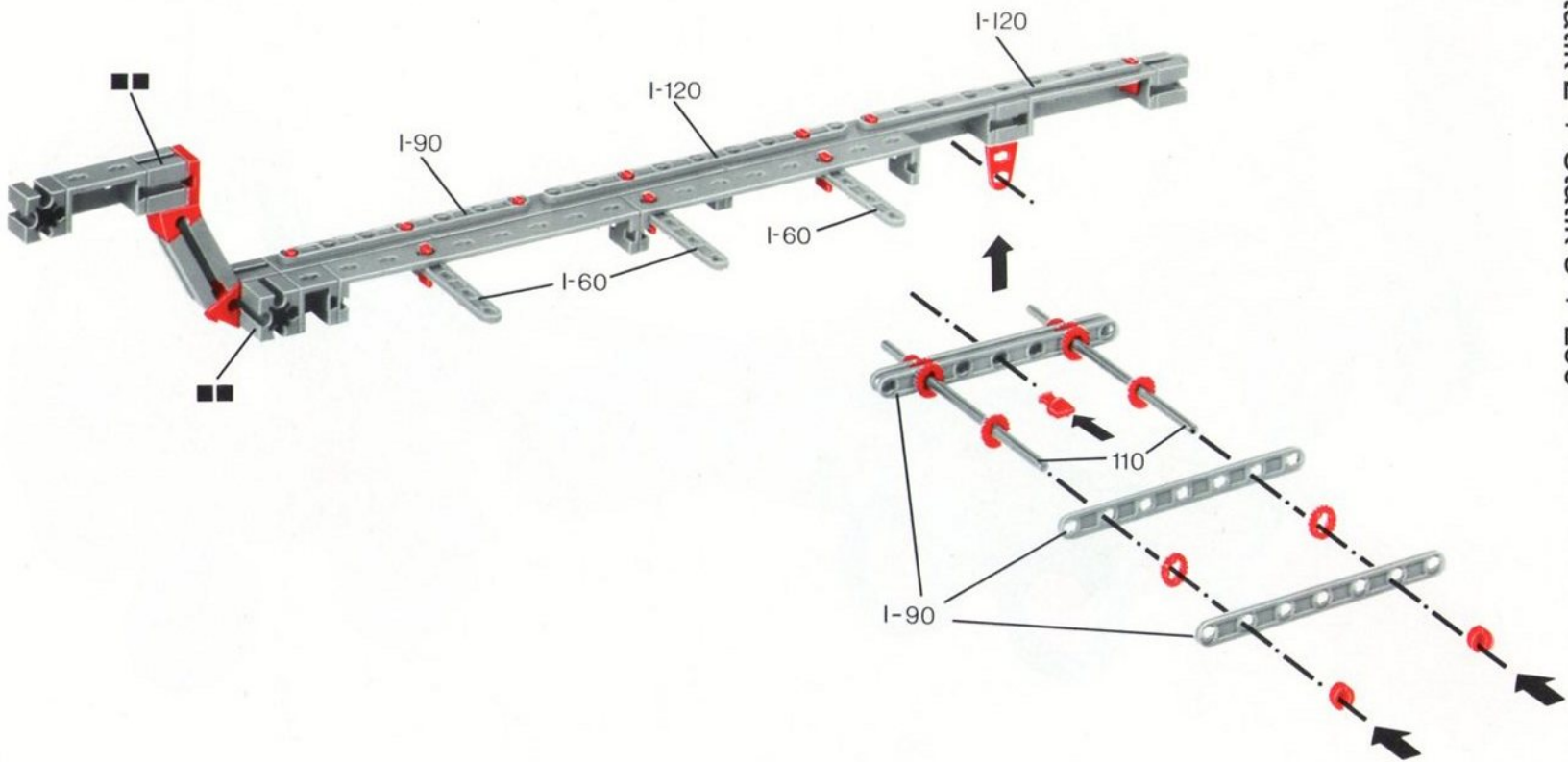

Statik 1 + Statik 2 + Statik 3 + 200





Statik 1 + Statik 2 + Statik 3 + 200

Statik 1 + Statik 2 + Statik 3 + 300

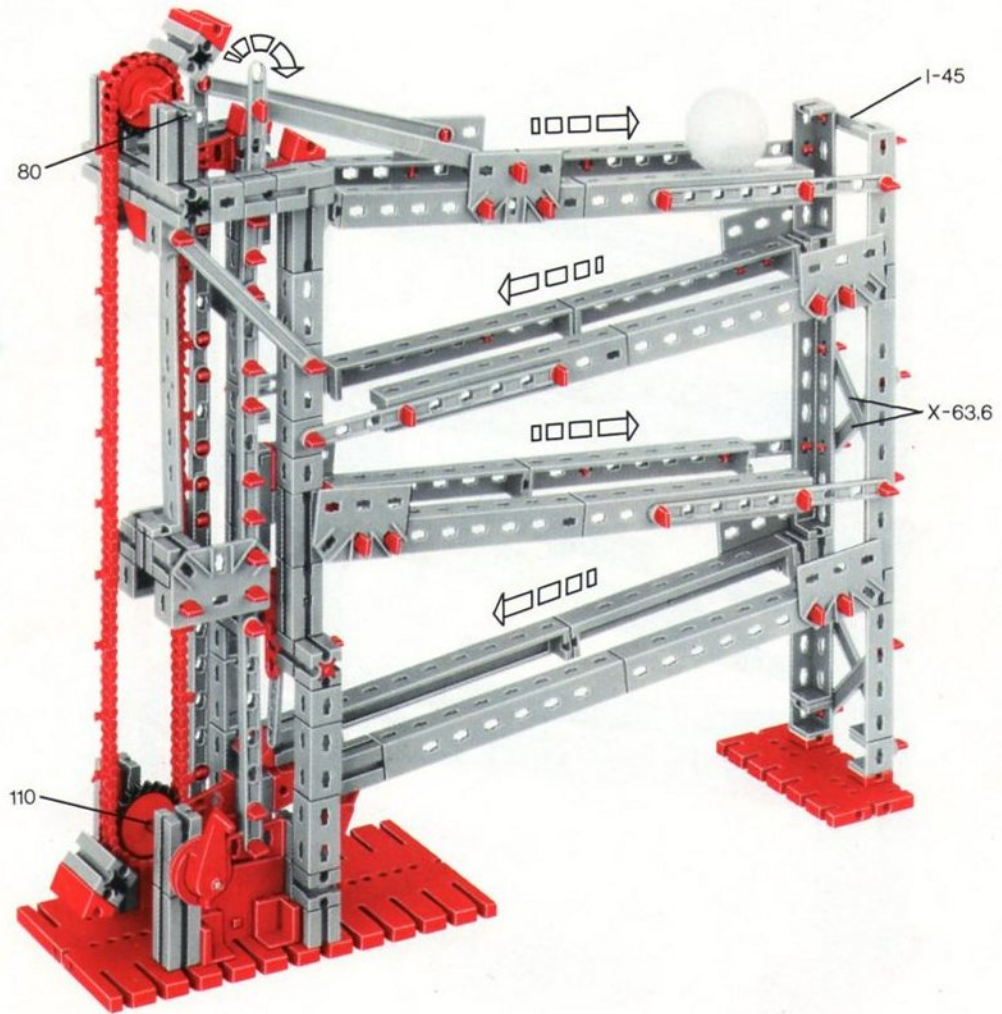

Statik 1 + Statik 2 + Statik 3 + 300

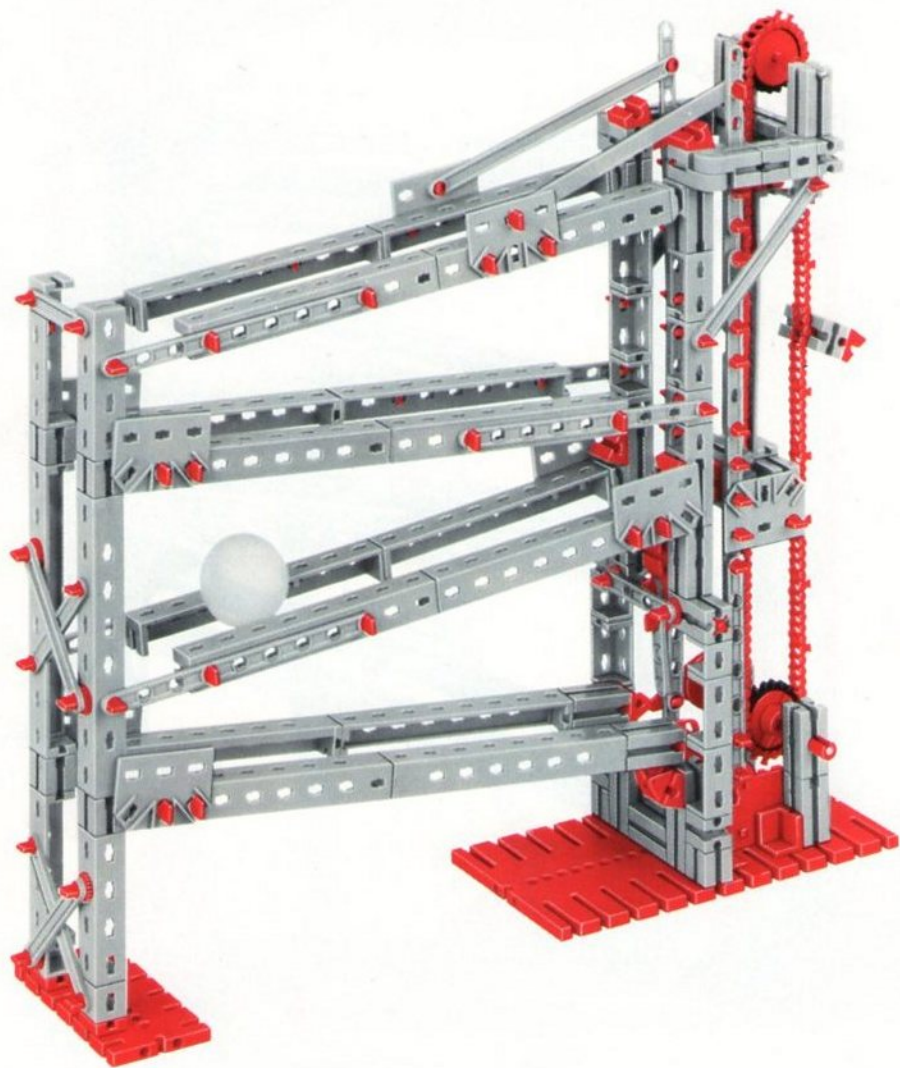

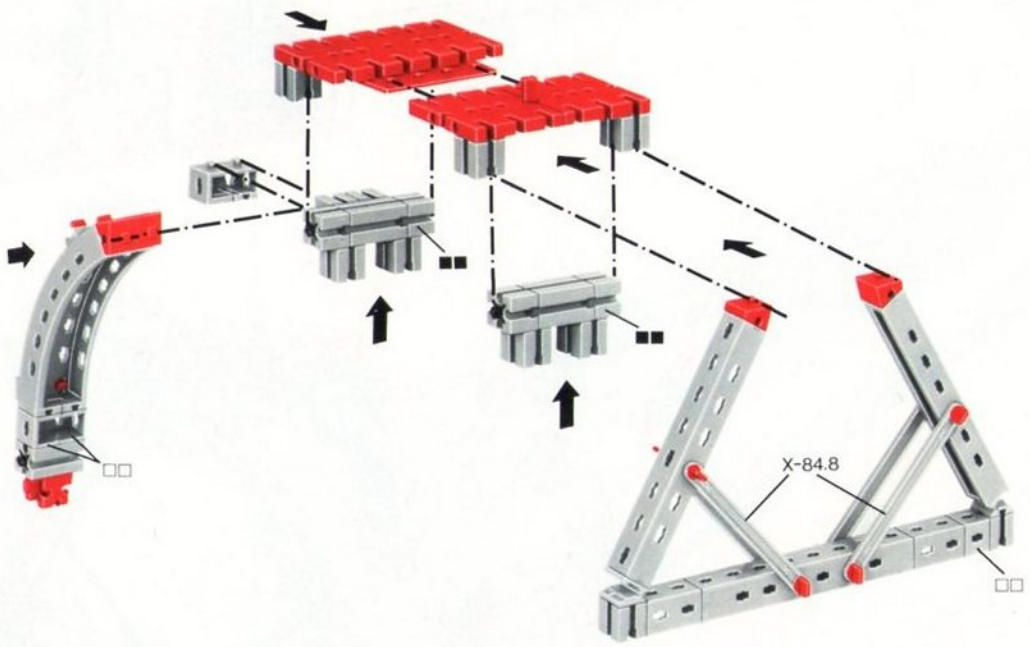

Statik 1 + Statik 2 + Statik 3 + 300

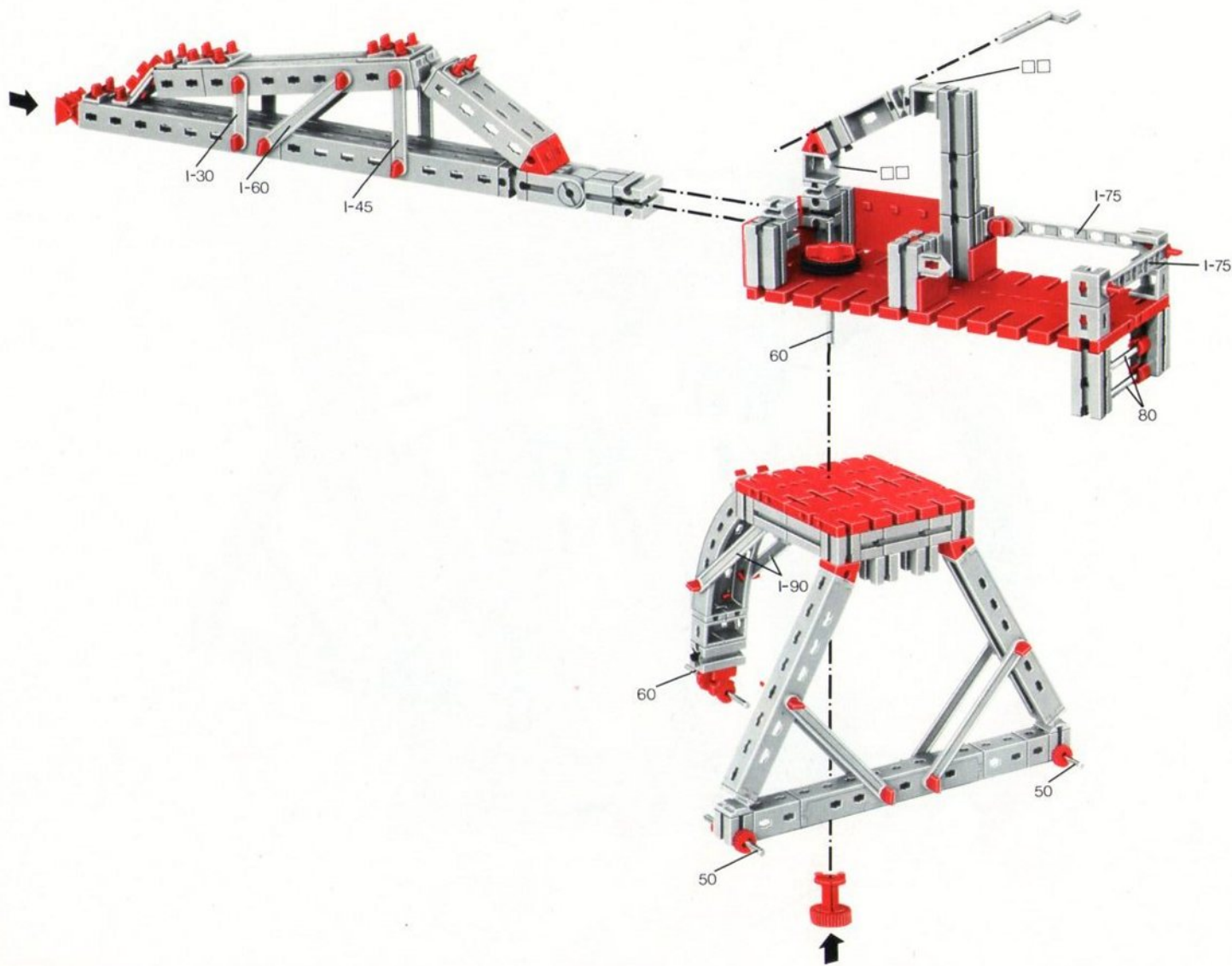



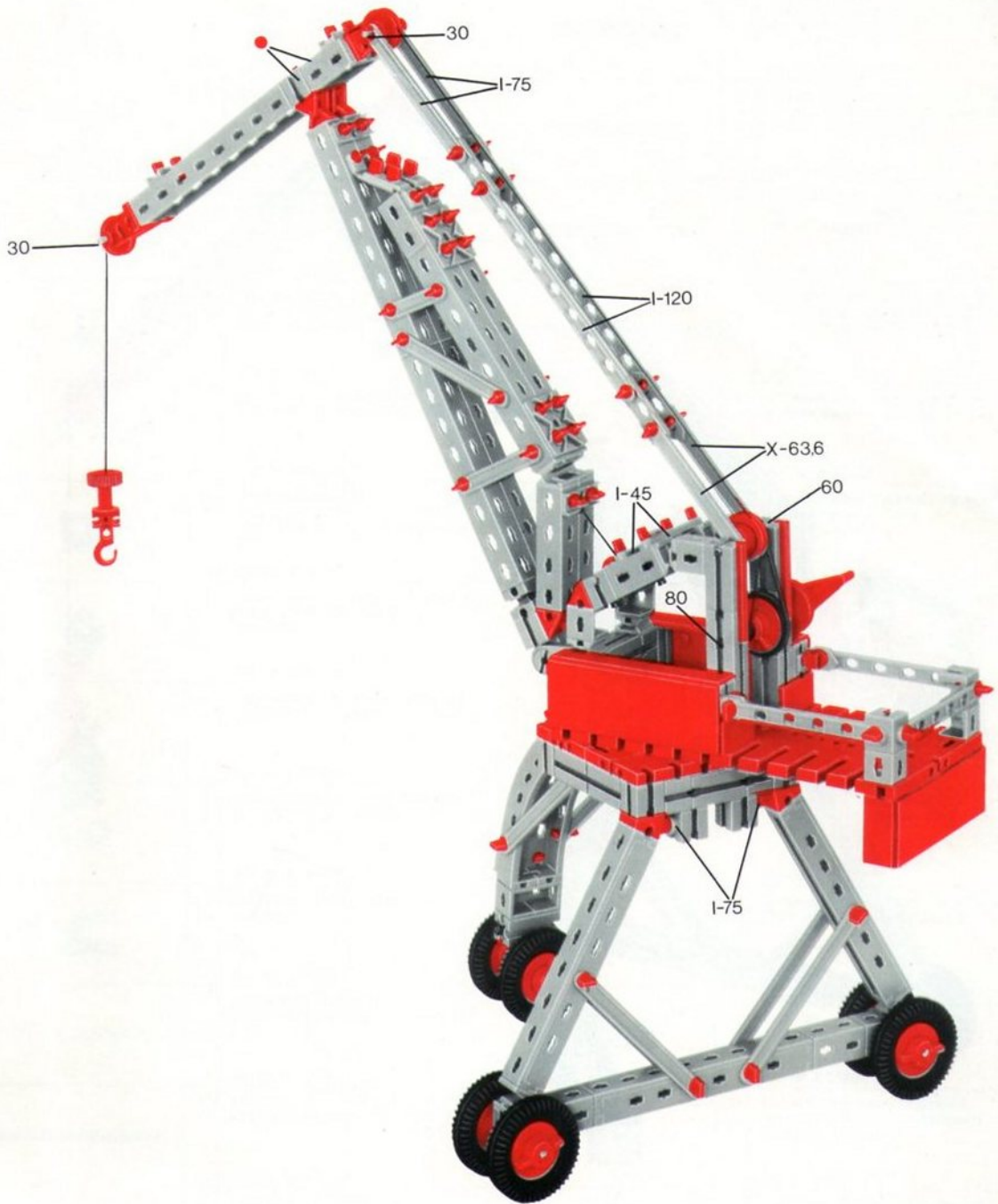

























Statik 1 + Statik 2 + Statik 3 + 300



Statik 1 + Statik 2 + Statik 3 + 300



Stückliste · Parts List · Nomenclature · Onderdelenlijst

	6	Platte 90 x 90 · Panel 90 x 90 · Plaque 90 x 90 · Plaat 90 x 90		4	I-Strebre 45 mit Loch · I-strut 45 with holes · Entretoise type I à perf. mult. de 45 · I-spant 45 met gat
		Art. Nr. 4 35431 1			Art. Nr. 4 38536 1
	4	L-Lasche · L-gusset · Gousset en L · L-verbinding		2	I-Strebre 60 mit Loch · I-strut 60 with holes · Entretoise type I à perf. mult. de 60 · I-spant 60 met gat
		Art. Nr. 4 31572 1			Art. Nr. 4 38535 1
	4	T-Lasche · T-gusset · Gousset en T · T-verbinding		4	I-Strebre 75 mit Loch · I-strut 75 with holes · Entretoise type I à perf. mult. de 75 · I-spant 75 met gat
		Art. Nr. 4 31573 1			Art. Nr. 4 38534 1
	2	Kreuzlasche · Cross gusset · Gousset en croix · Kruisverbinding		4	I-Strebre 90 mit Loch · I-strut 90 with holes · Entretoise type I à perf. mult. de 90 · I-spant 90 met gat
		Art. Nr. 4 31574 1			Art. Nr. 4 38533 1
	4	Adapterlasche · Adapter gusset · Gousset adaptateur · Adapterverbinding		4	I-Strebre 120 mit Loch · I-strut 120 with holes · Entretoise type I à perf. mult. de 120 · I-spant 120 met gat
		Art. Nr. 4 31575 1			Art. Nr. 4 38532 1
	2	Lasche 15 · Connecting strip 15 · Éclisse de 15 · Rechtverbinding 15		4	Winkellasche · Flexible angle strip · Eclisse coudée · Hoekverbinding
		Art. Nr. 4 36326 1			Art. Nr. 4 35738 1
	4	Winkelverbinder 30 · Angel connector 30 · Cornière de reprise de 30 · Haakse verbinding		2	Gelenklasche · Flexible connecting strip · Eclisse articulée · Scharnierstuk
		Art. Nr. 4 31576 1			Art. Nr. 4 36330 1
	4	Eckverbinder · Corner connector · Cornière de reprise d'angle · Hoekstuk		70	S-Riegel 4 · Single rivet 4 mm · Rivet de 4 mm · S-grendel 4 mm
		Art. Nr. 4 31577 1			Art. Nr. 4 36323 1
	4	Winkelträger 15 · Angle girder 15 · Cornière de 15 · Hoekdraagsteun 15		15	S-Riegel 6 · Double rivet 6 mm · Rivet de 6 mm · S-grendel 6 mm
		Art. Nr. 4 36300 1			Art. Nr. 4 36324 1
	4	Winkelträger 30 · Angle girder 30 · Cornière de 30 · Hoekdraagsteun 30		4	S-Riegel 8 · Triple rivet 8 mm · Rivet de 8 mm · S-grendel 8 mm
		Art. Nr. 4 36301 1			Art. Nr. 4 36457 1
	4	Scharnier · Hinge · Charnière · Scharnier		15	Riegelscheibe · Locking washer · Disque d'arrêt · Grendelschijf
		Art. Nr. 4 36329 1			Art. Nr. 4 36334 1
	4	I-Strebre 75 · I-strut 75 · Entretoise type I de 75 · I-spant 75		1	S-Griff · Rivet holder · Tourne-rivet · S-greep
		Art. Nr. 4 36312 1			Art. Nr. 4 35800 1
	4	I-Strebre 120 · I-strut 120 · Entretoise type I de 120 · I-spant 120		1	Kassetten-Unterteil · Cassette, bottom · Coffret, partie inférieure · Cassette, onderstuk
		Art. Nr. 4 36314 1			Art. Nr. 4 35359 1
	8	X-Strebre 106 · X-strut 106 · Entretoise type X de 106 · X-spant 106		1	Kassetten-Deckel · Cassette, top · Coffret, partie supérieure · Cassette, deksel
		Art. Nr. 4 36318 1			Art. Nr. 4 35360 1
	4	I-Strebre 30 mit Loch · I-strut 30 with holes · Entretoise type I à perf. mult. de 30 · I-spant 30 met gat			
		Art. Nr. 4 38537 1			

