

fischer[®]technik

Ergänzung zu den Grundkästen

Statik 3

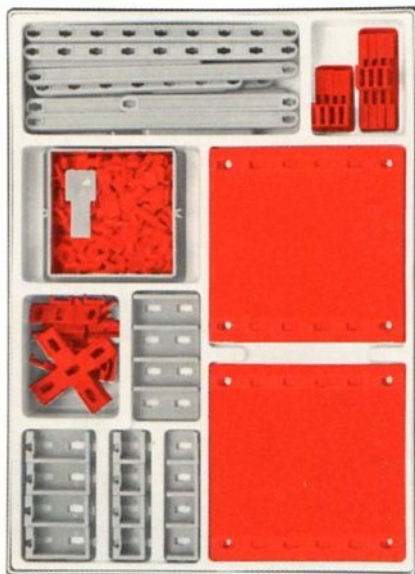

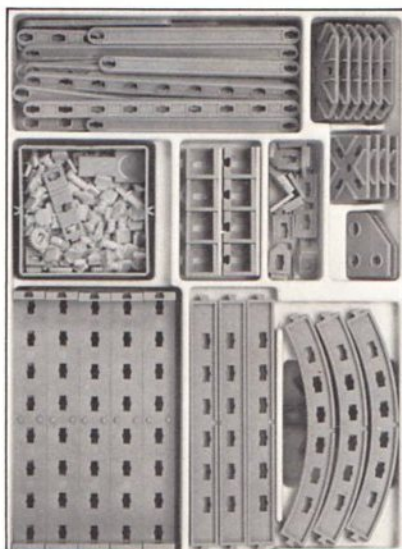
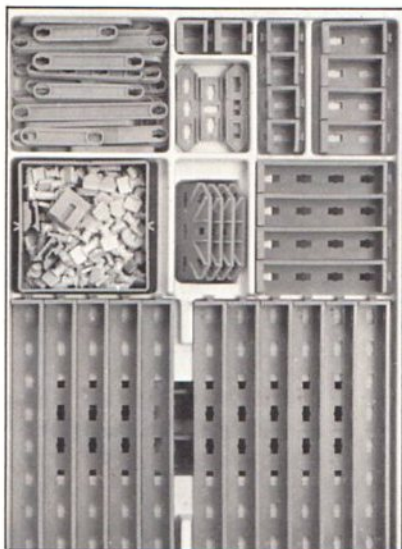
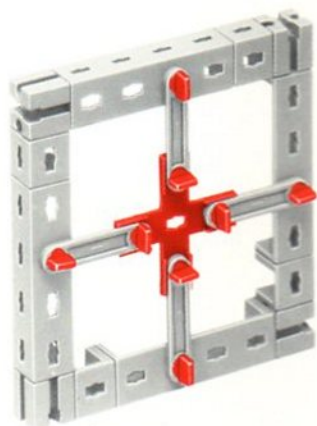

Zusammenbau der Einzelteile
This is how the parts fit together
Assemblage des pièces
Aan elkaar verbinden van de onderdelen



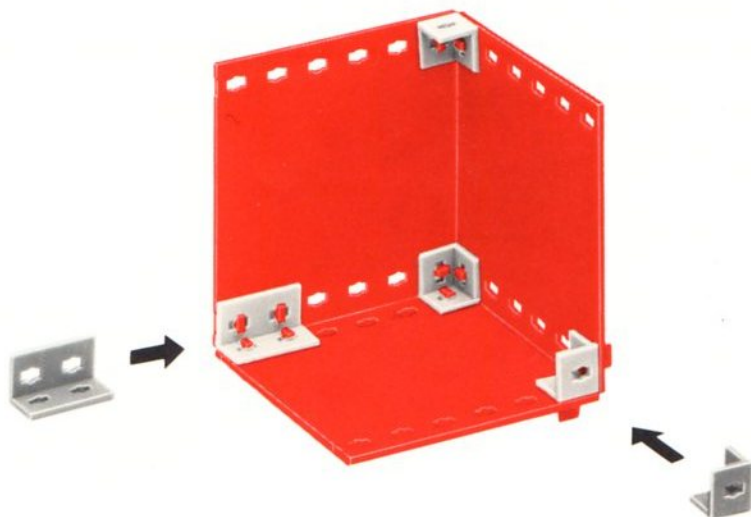

Zusammenbau der Einzelteile
This is how the parts fit together
Assemblage des pièces
Aan elkaar verbinden van de onderdelen

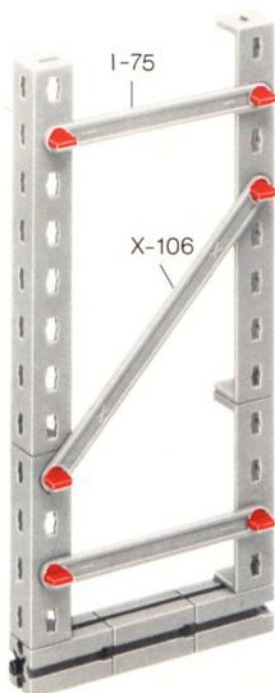

Statik 3 + 50

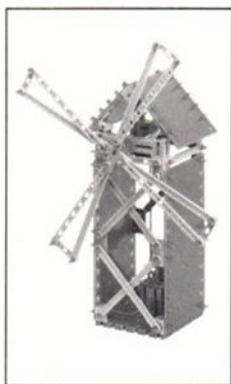

Windmühle
Windmill
Moulin à vent
Windmolen

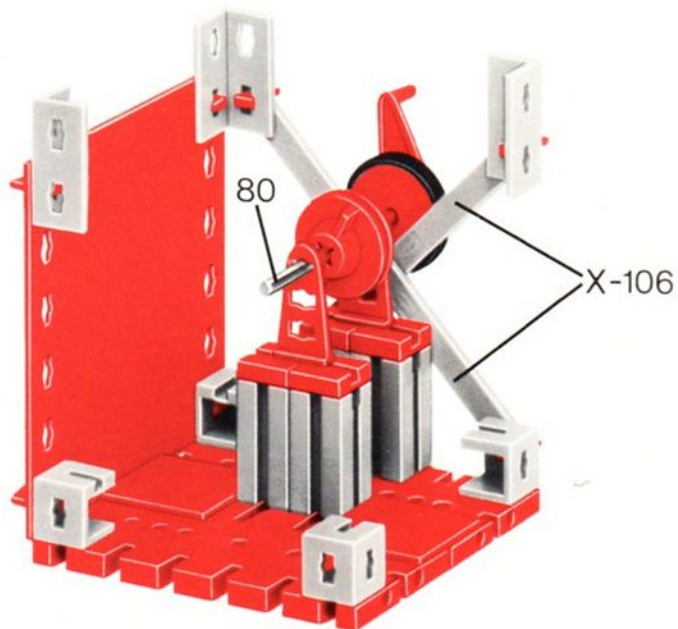
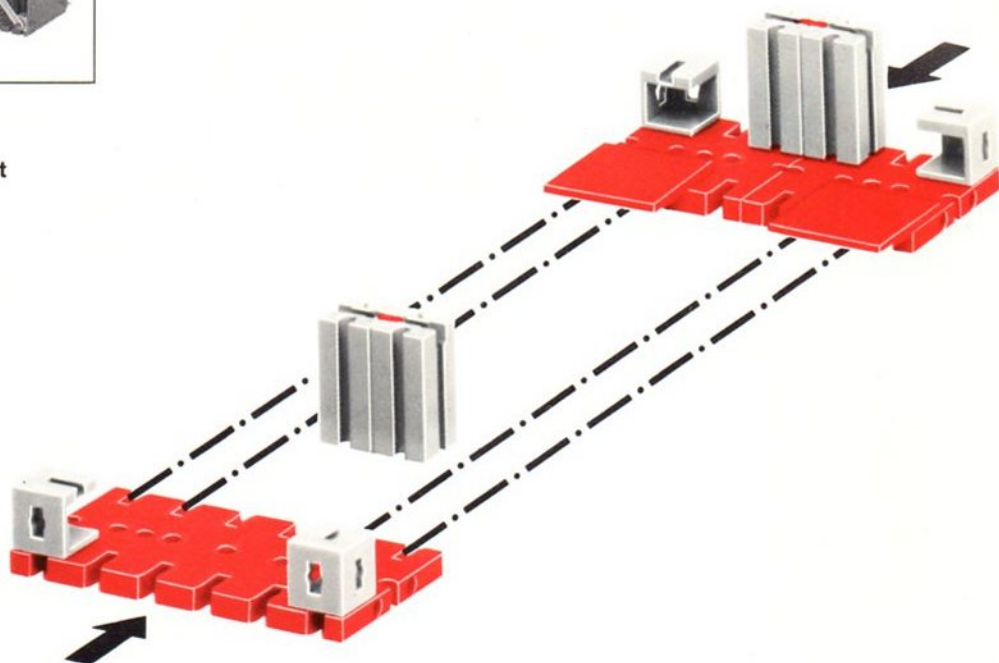

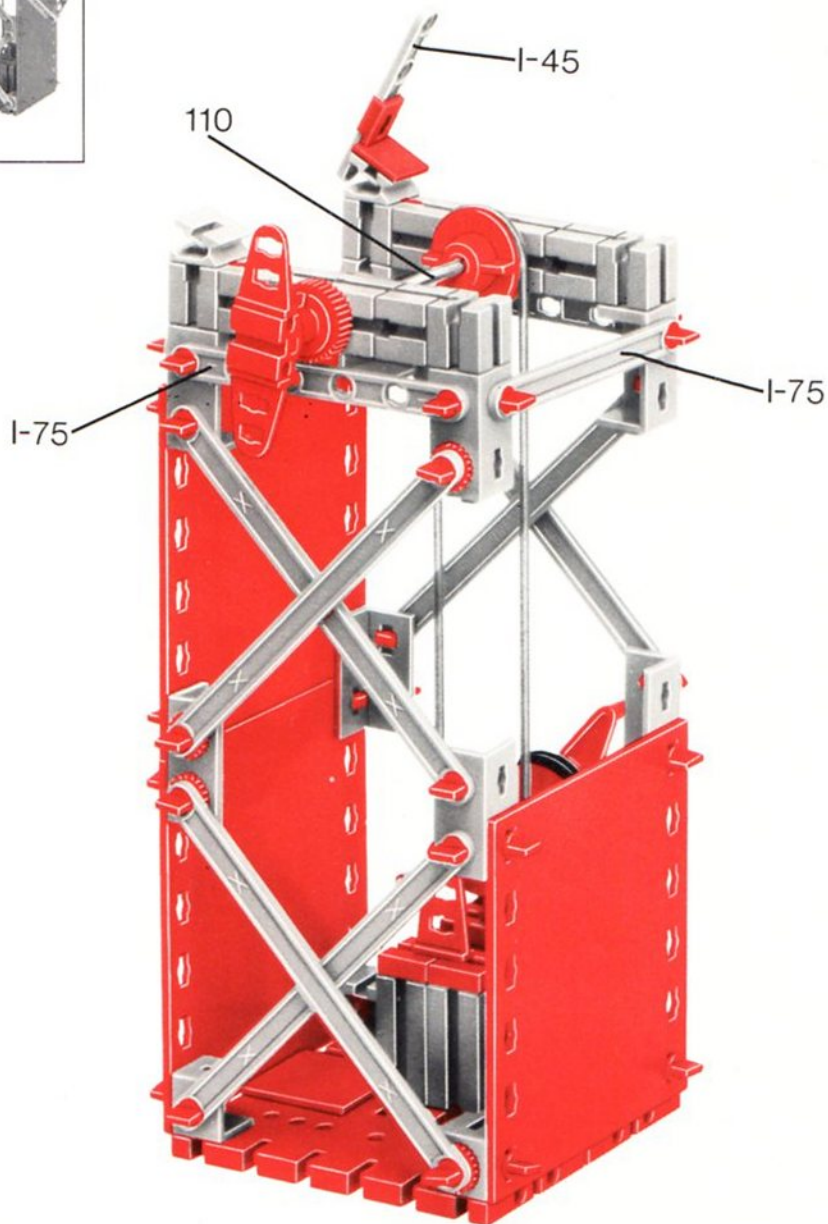
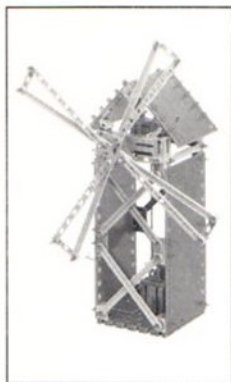

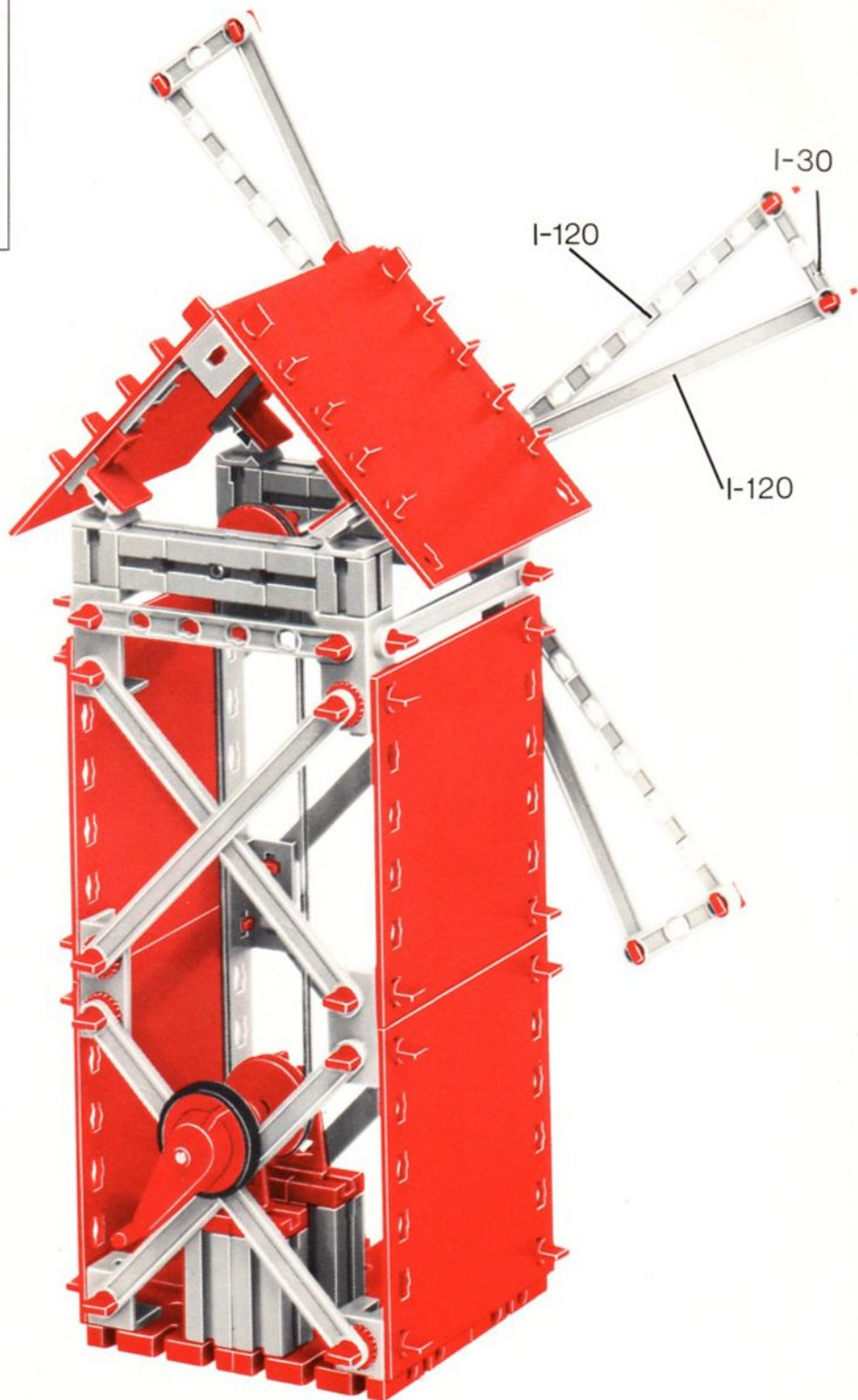
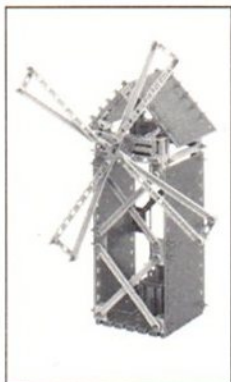

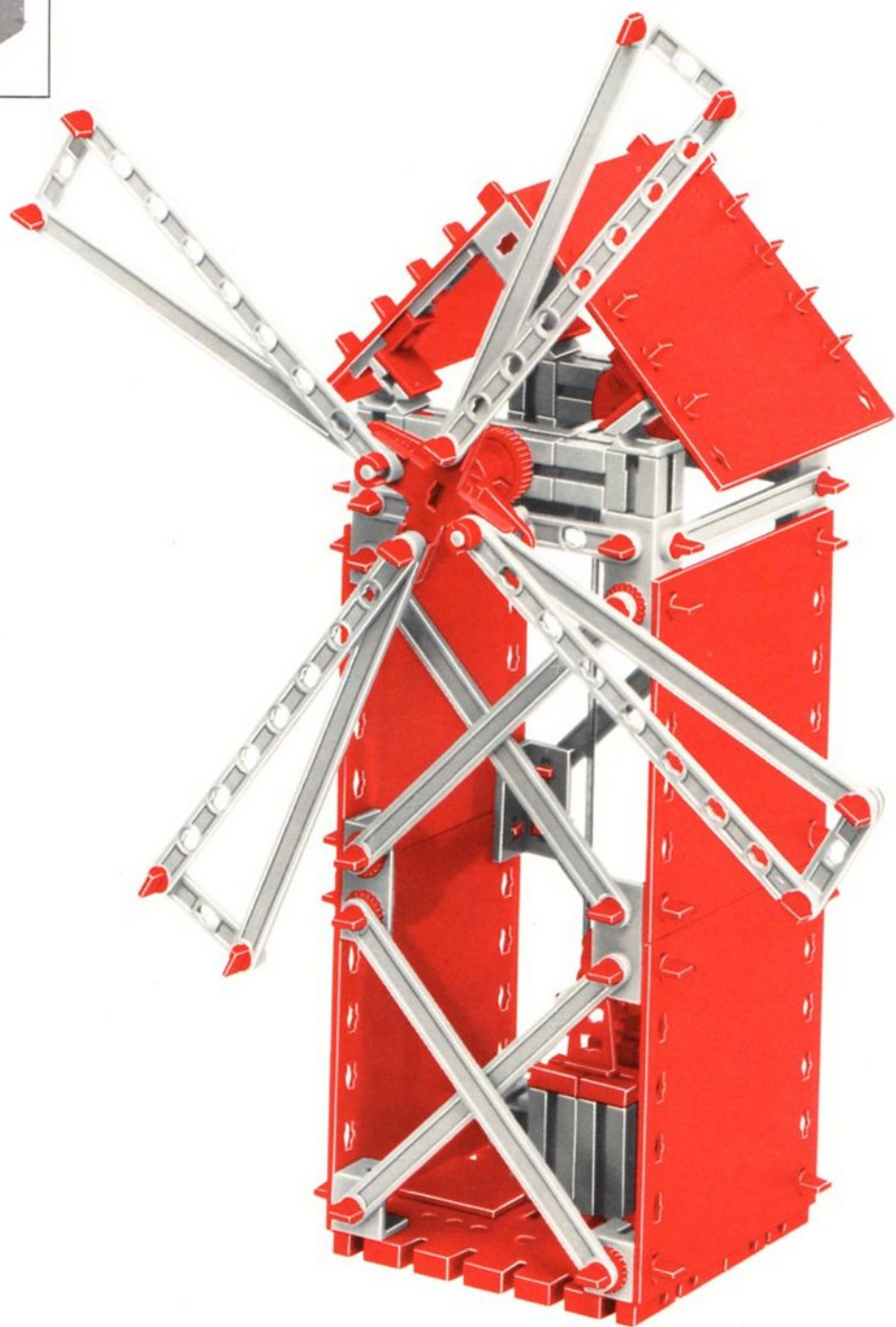
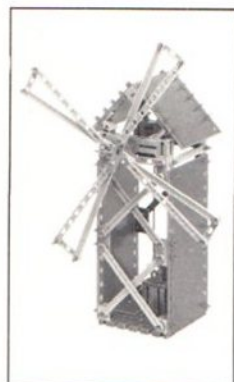

Statik 1 + Statik 2 + Statik 3 + 50



Bogenbrücke
Arched bridge
Pont à arches
Boogbrug

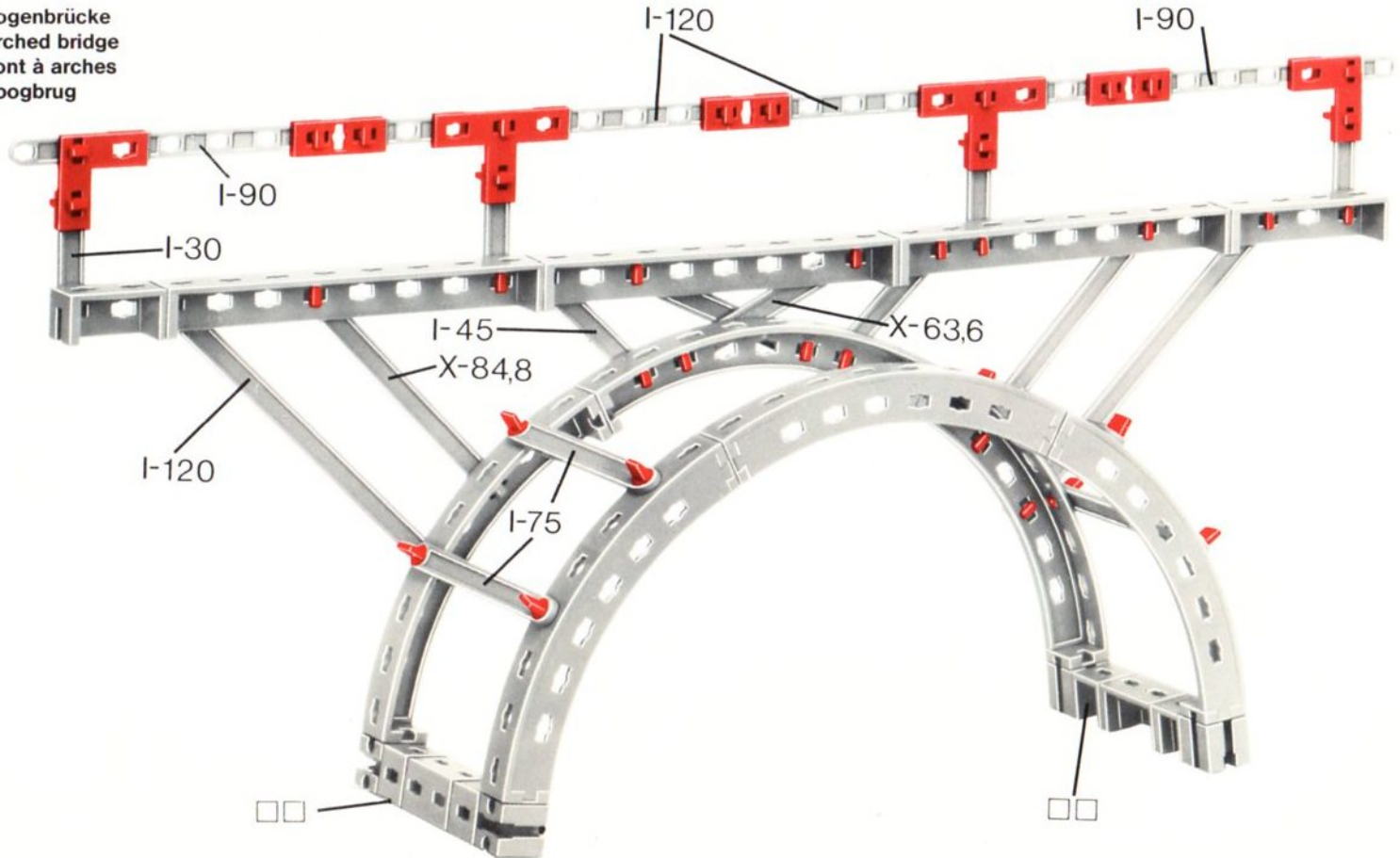

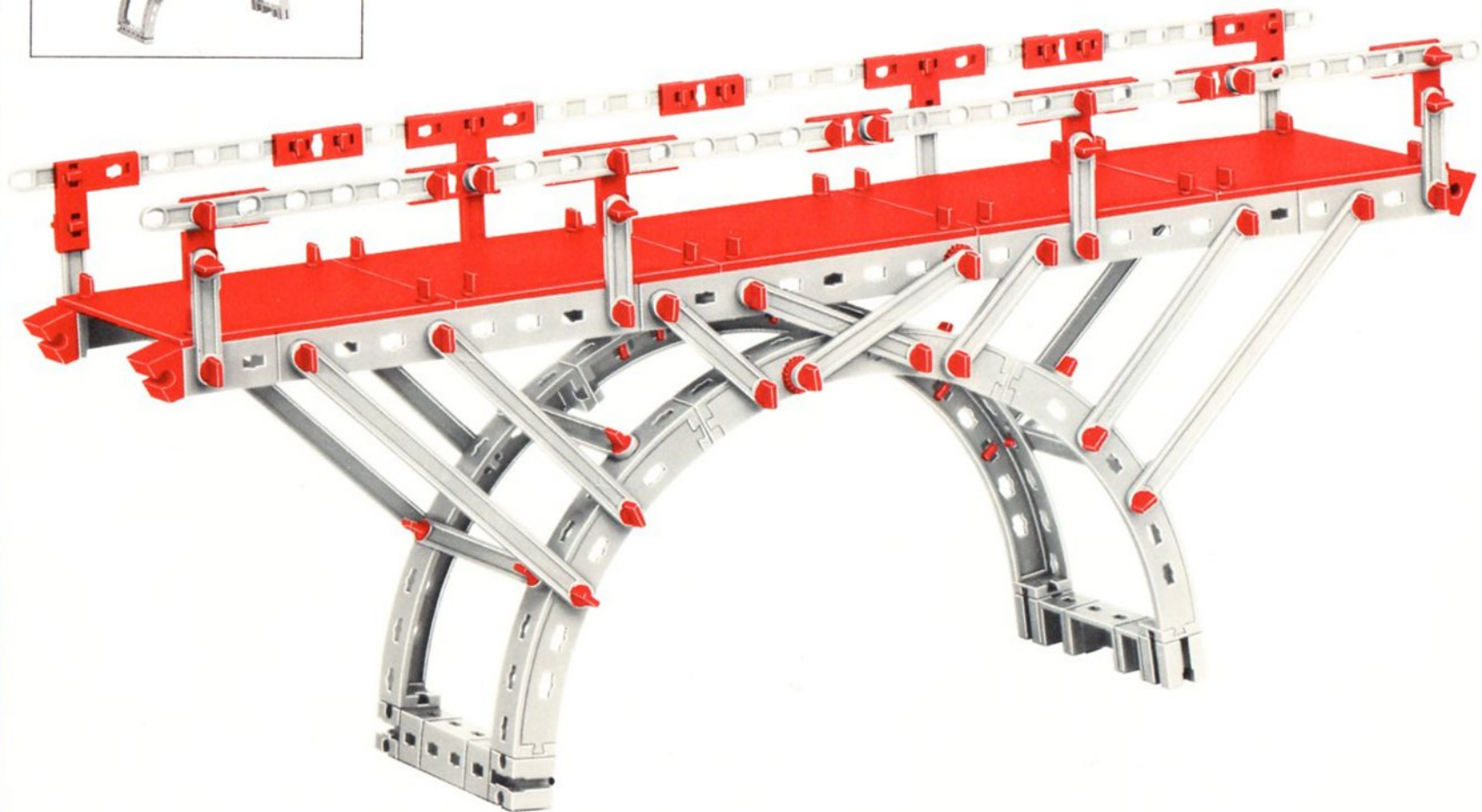

Statik 1 + Statik 2 + Statik 3 + 100

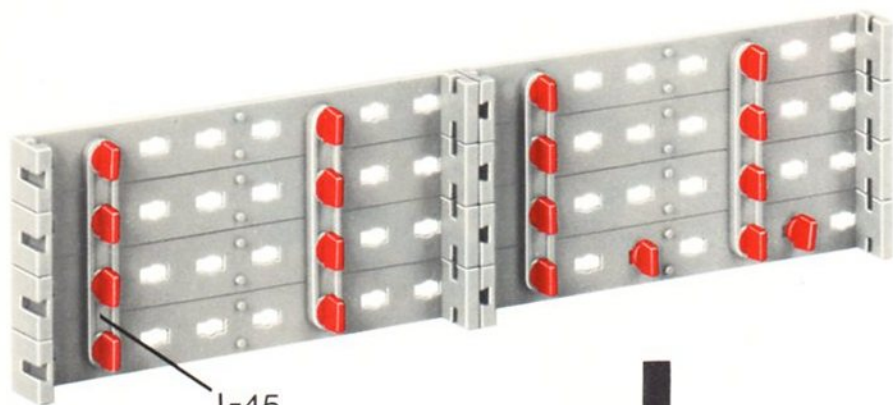

Ziehbrunnen
Water well with
bucket
Puits
Katrolwaterput

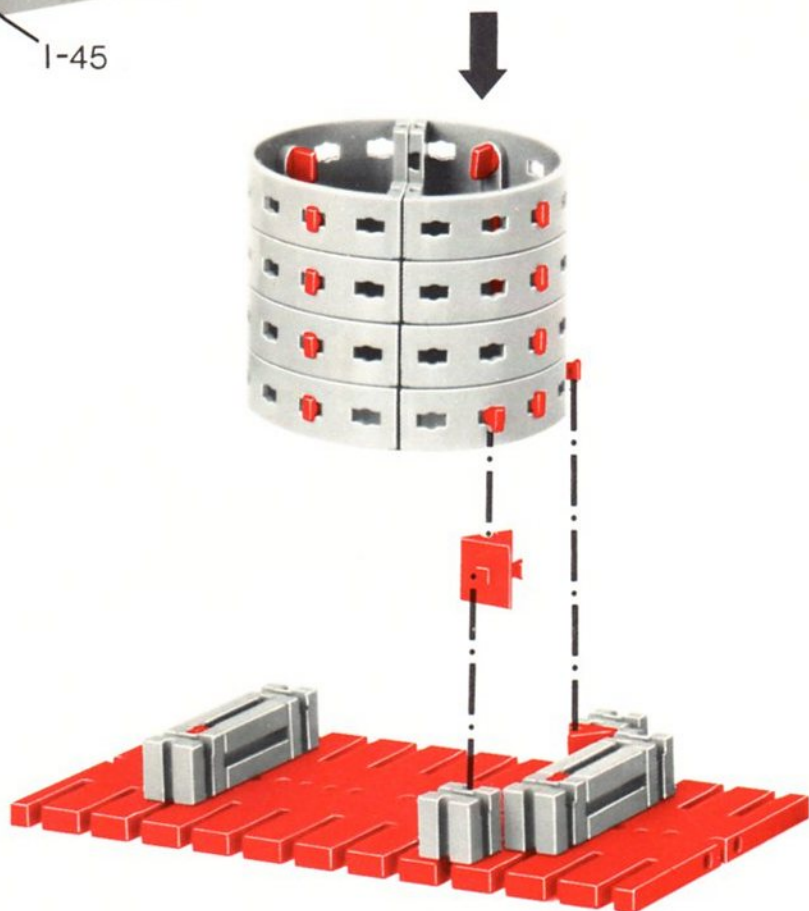

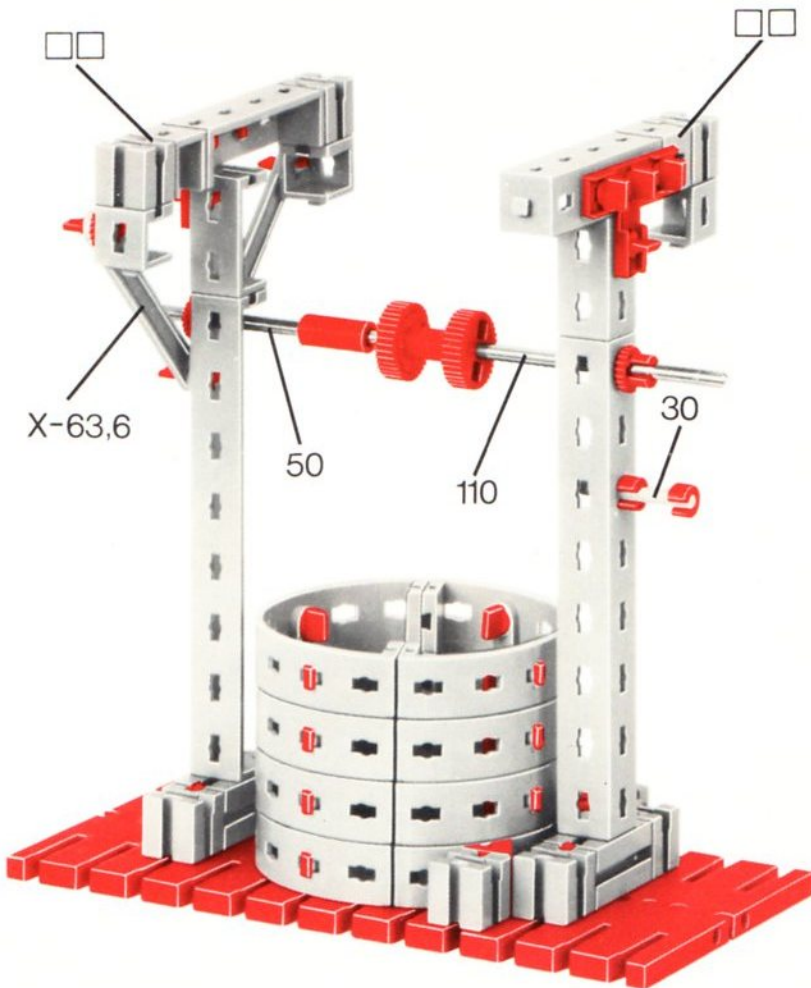

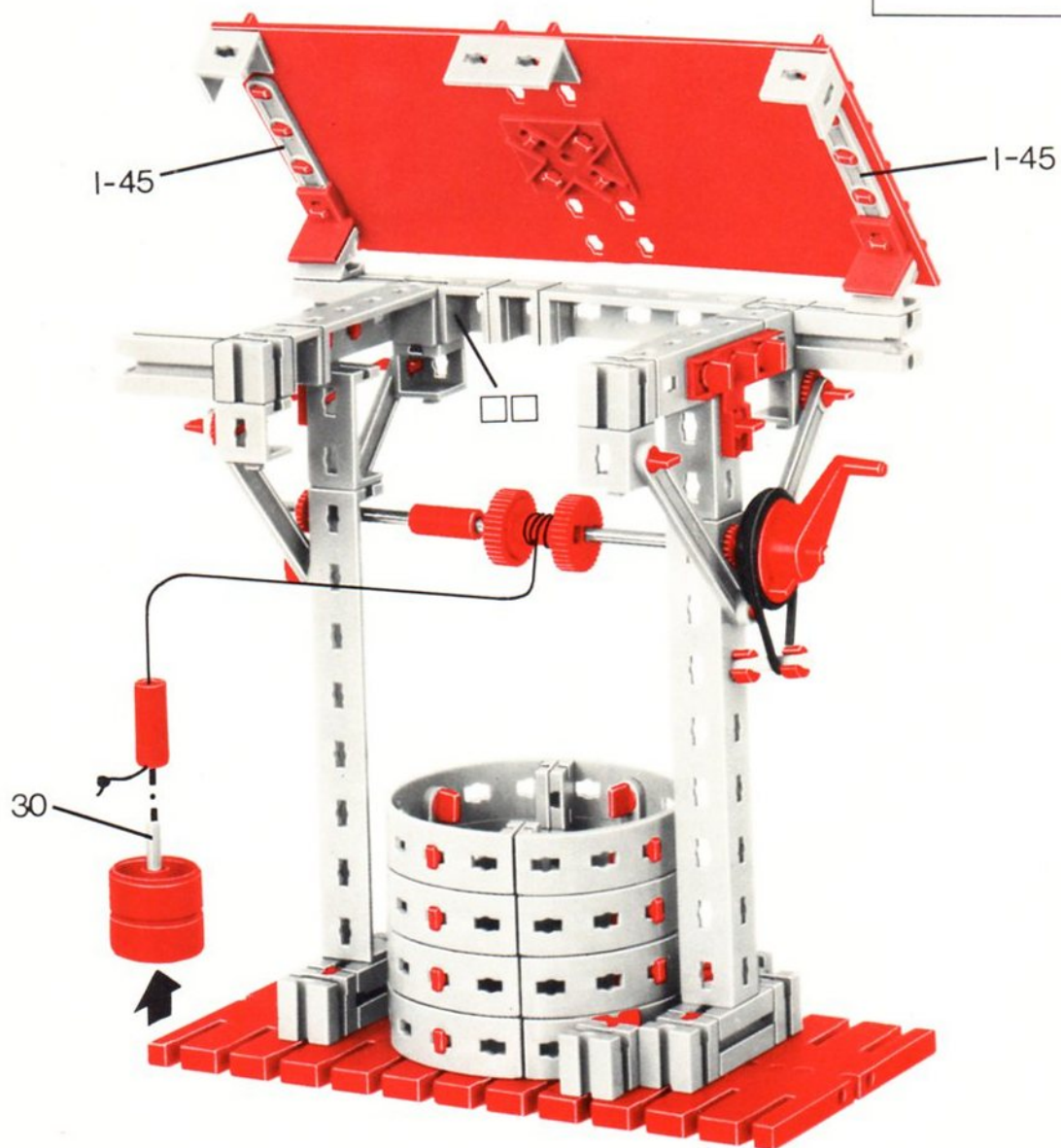

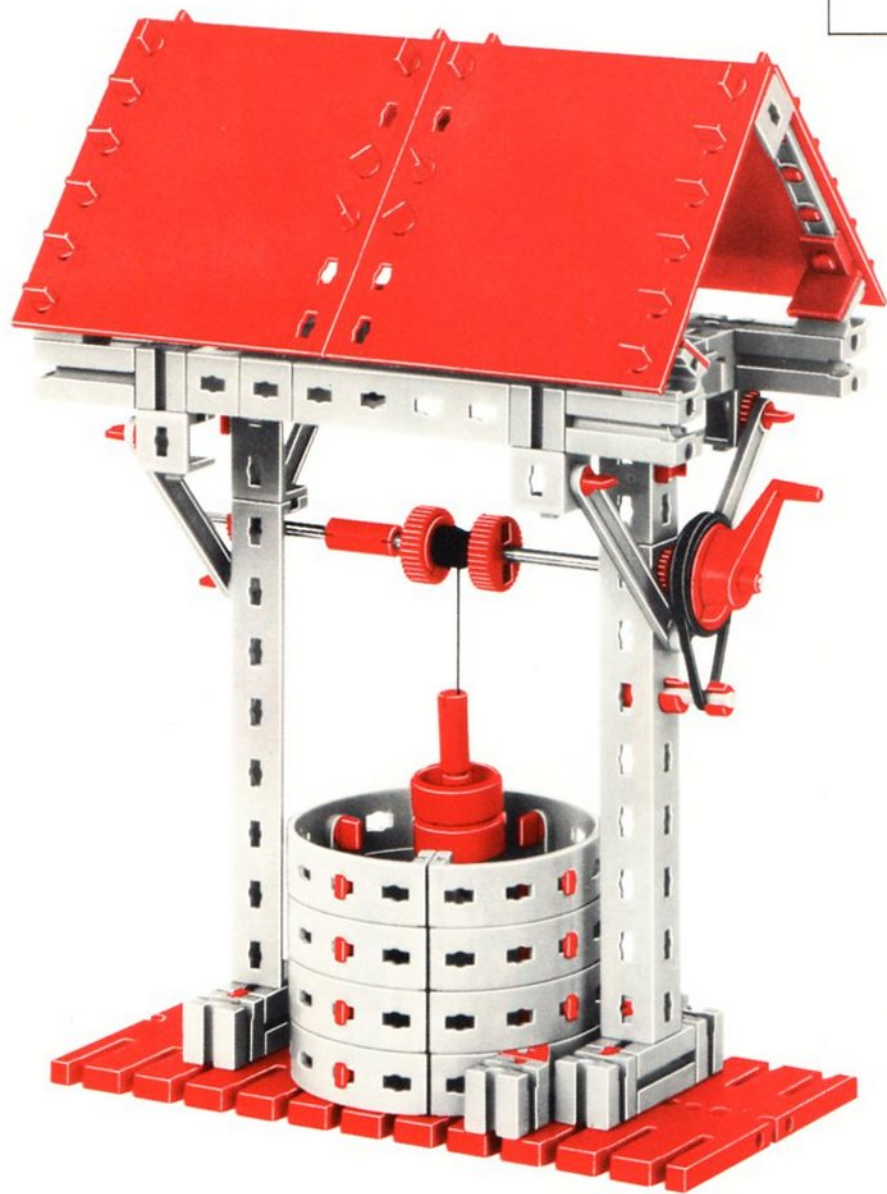

Statik 1 + Statik 2 + Statik 3 + 100



Bohrturm
Oil rig
Tour de forage
Boortoren

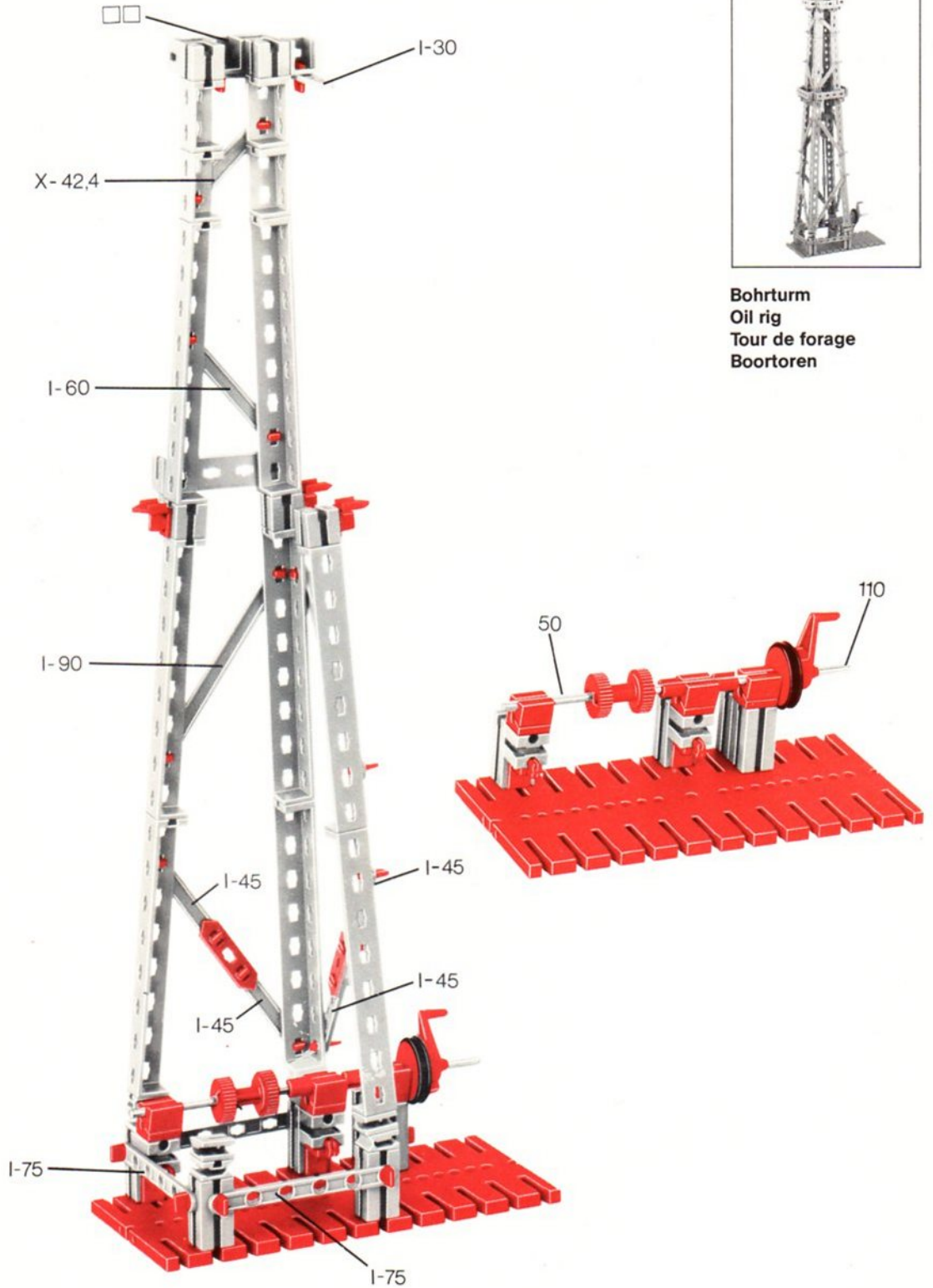

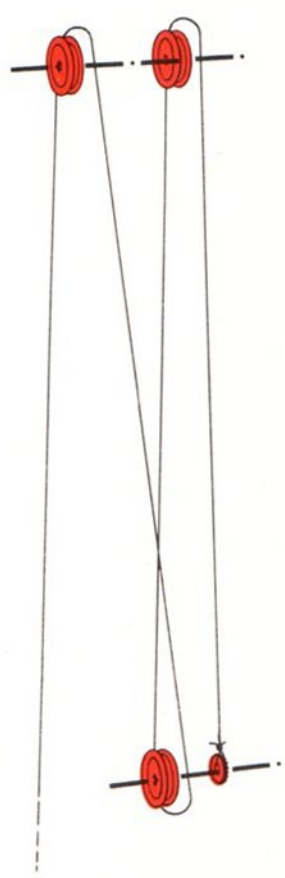
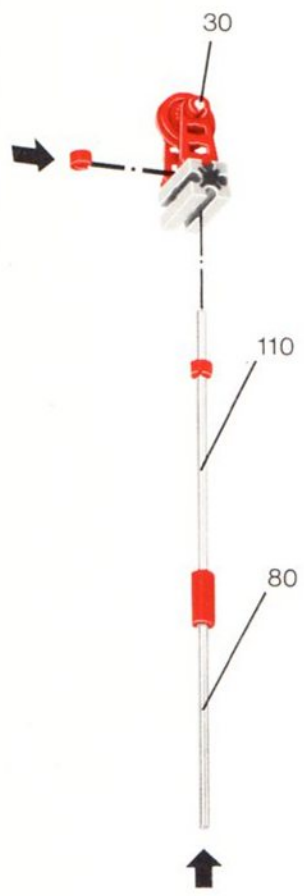
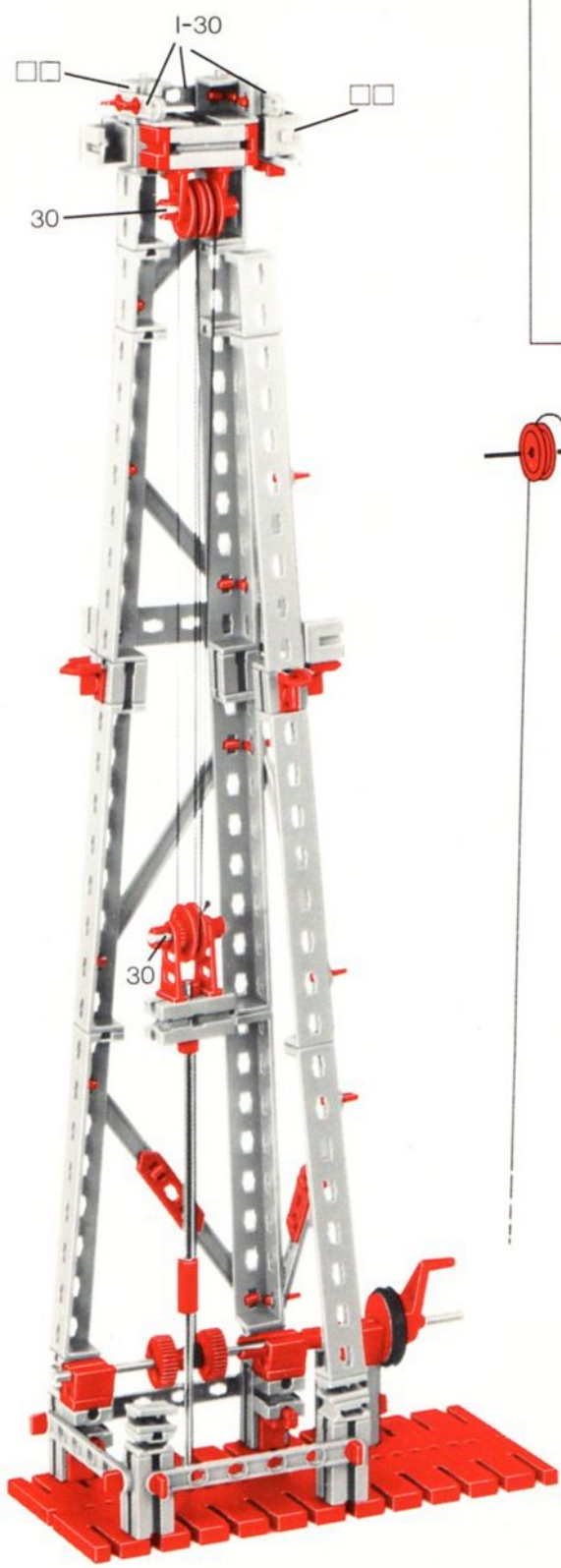



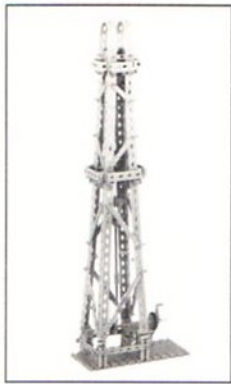

Statik 1 + Statik 2 + Statik 3 + 200



Lastwagen
Truck
Camion
Vrachtwagen

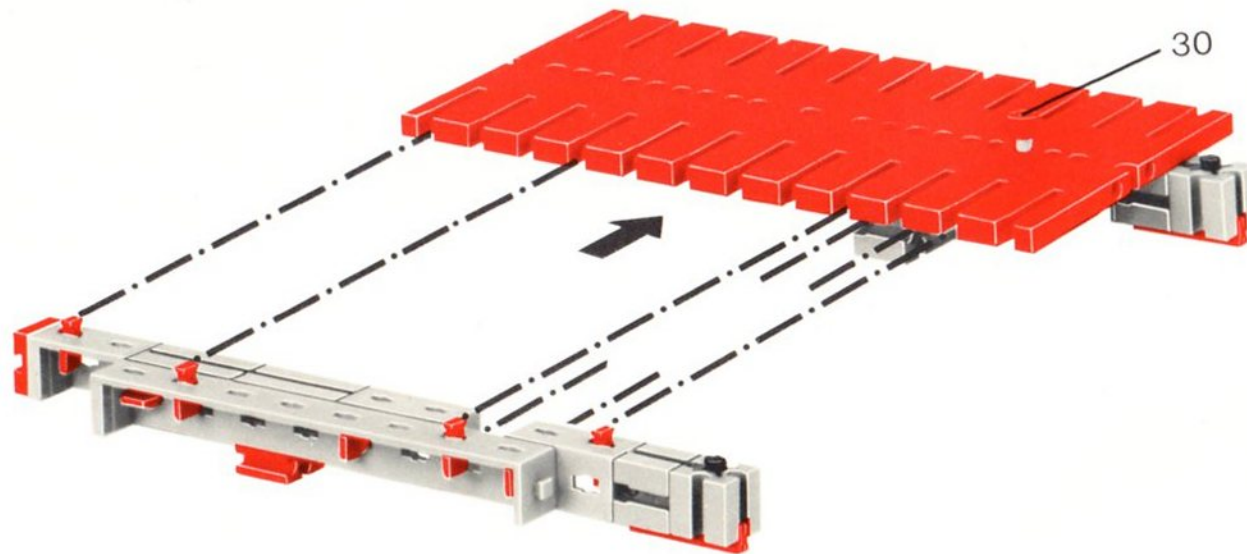

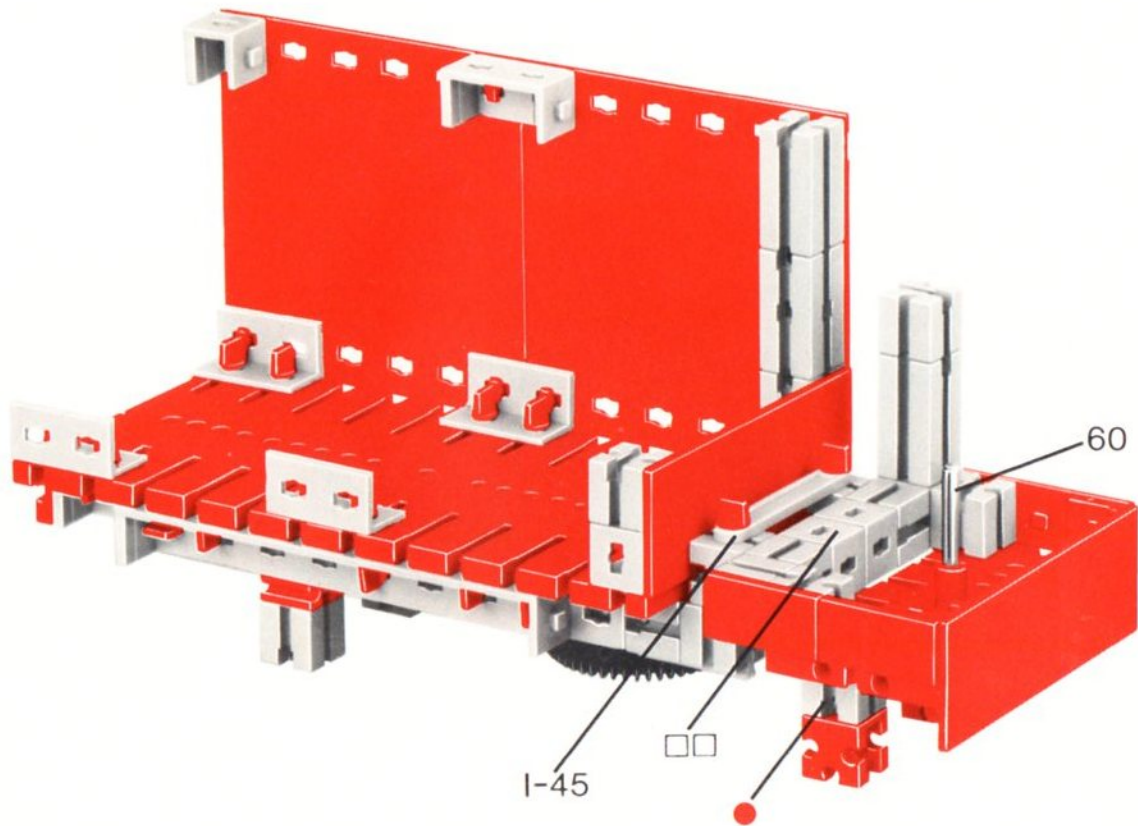

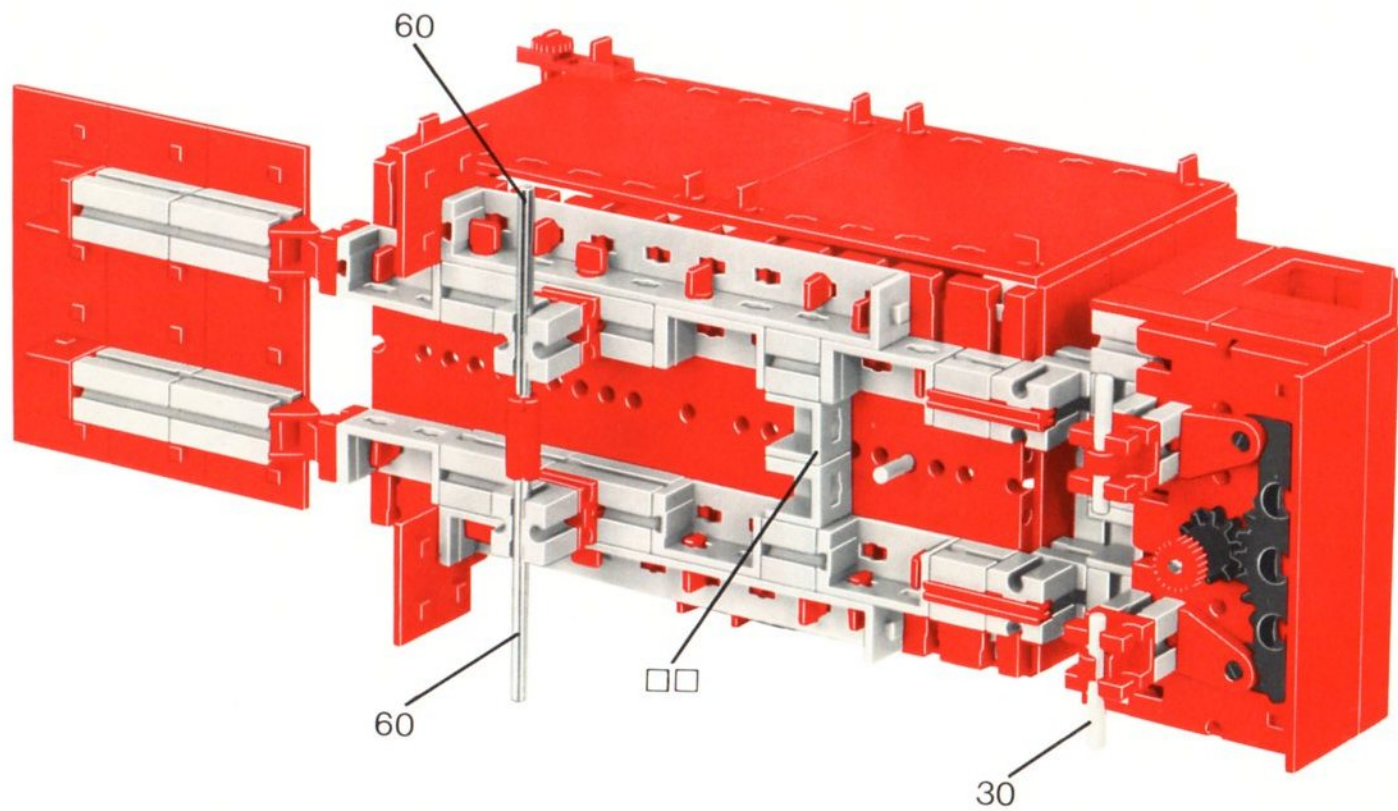





Statik 1 + Statik 2 + Statik 3 + 200



Sattelschlepper
Tractor trailer
Remorque
Oplegger

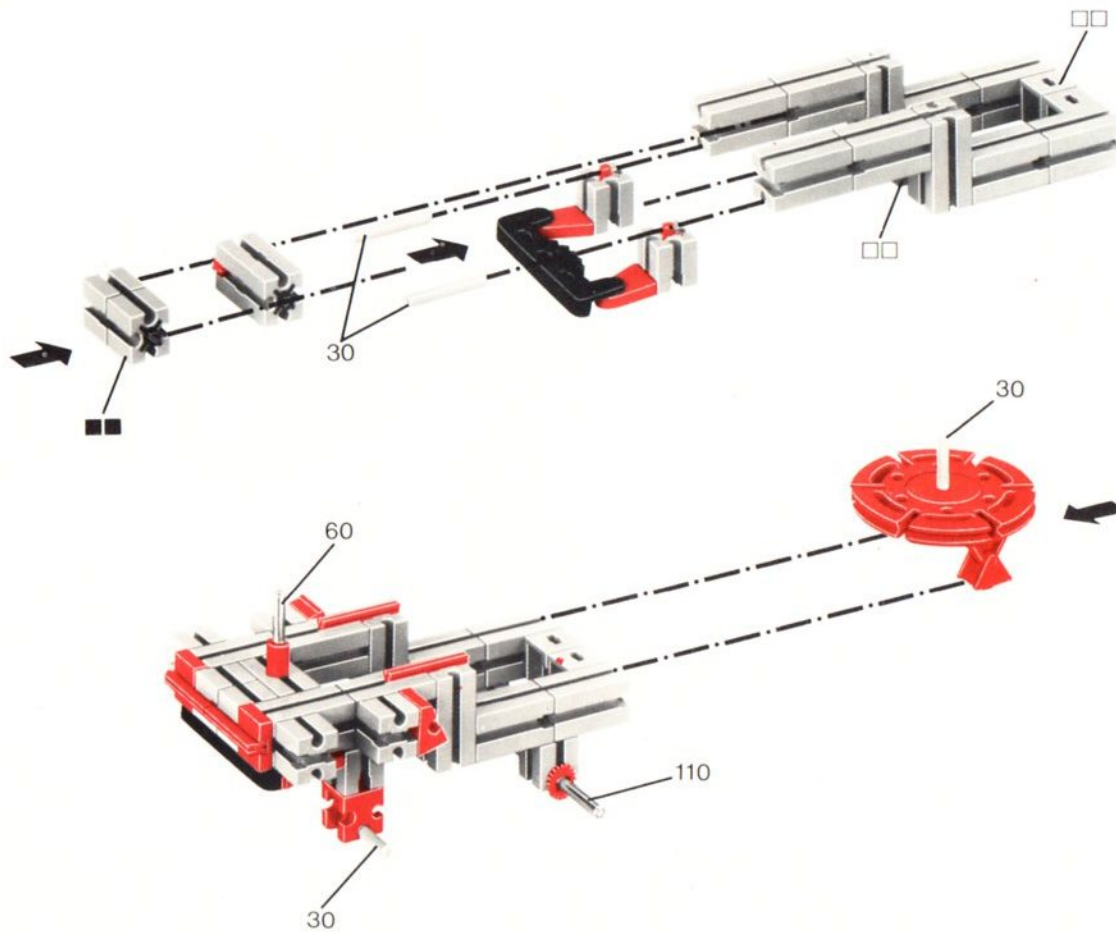



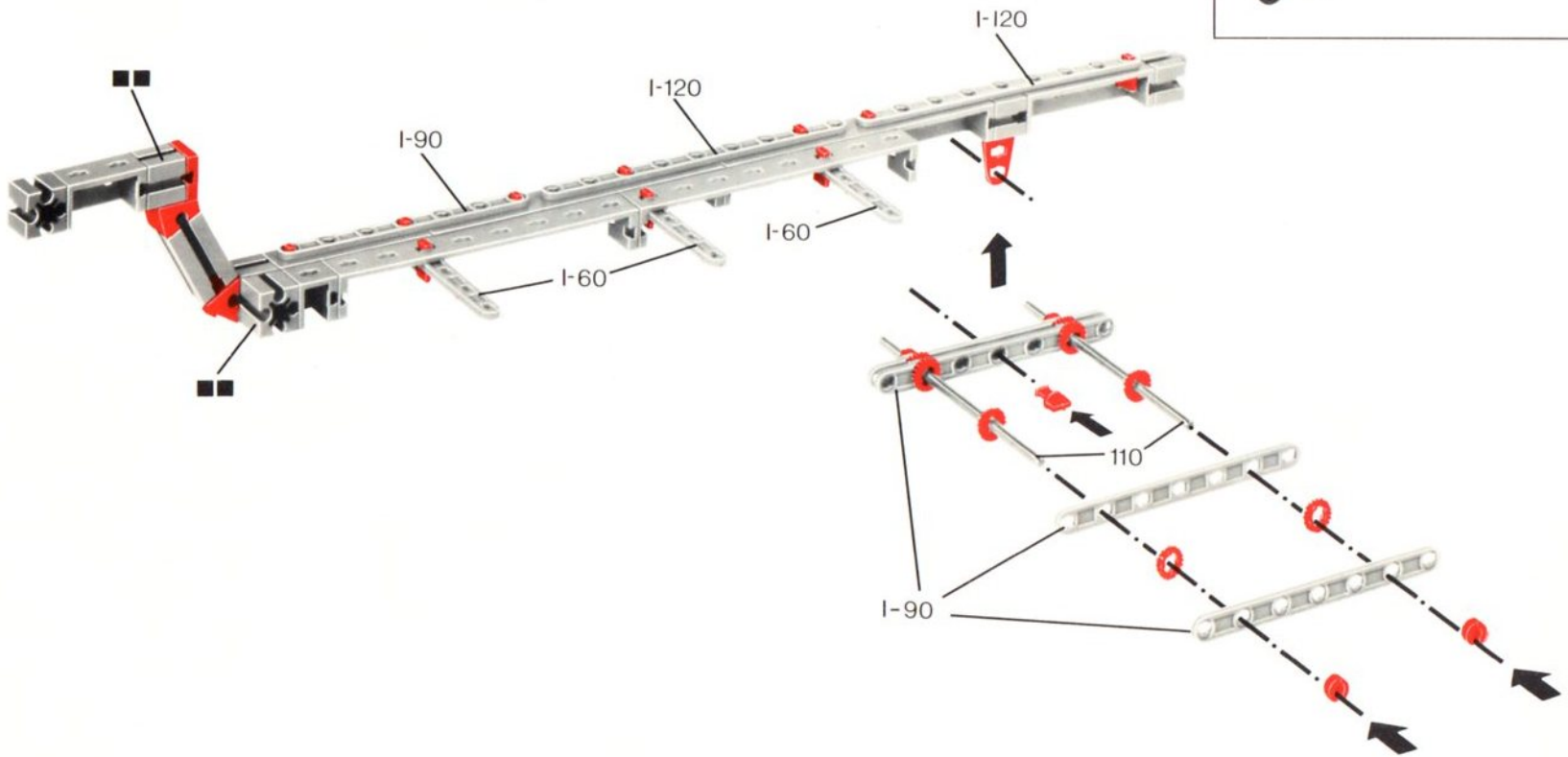

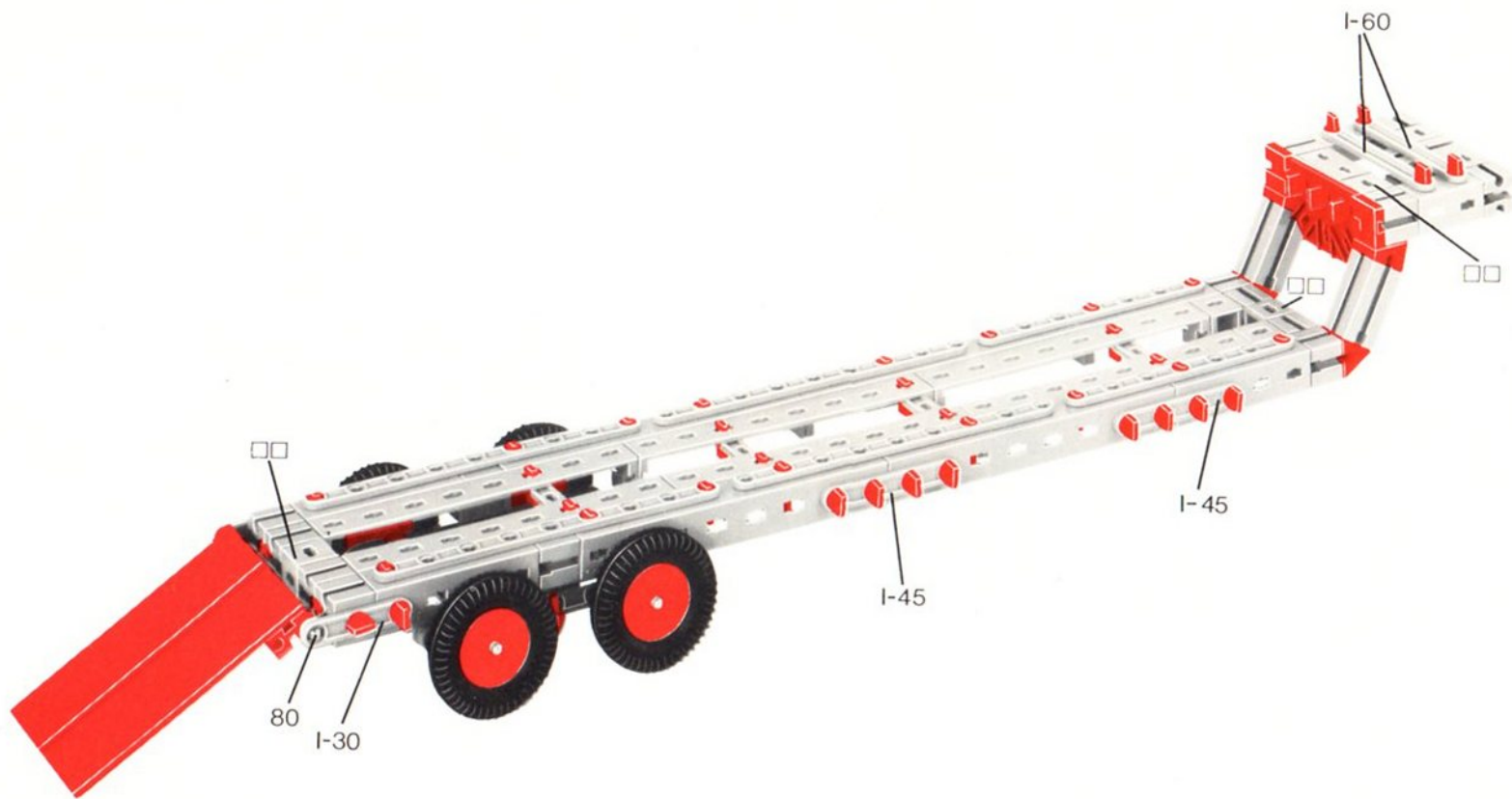



Statik 1 + Statik 2 + Statik 3 + 300



Kugelbahn
Descending table
tennis ball maze with
ball lift
Piste pour billes
Kugelbaan

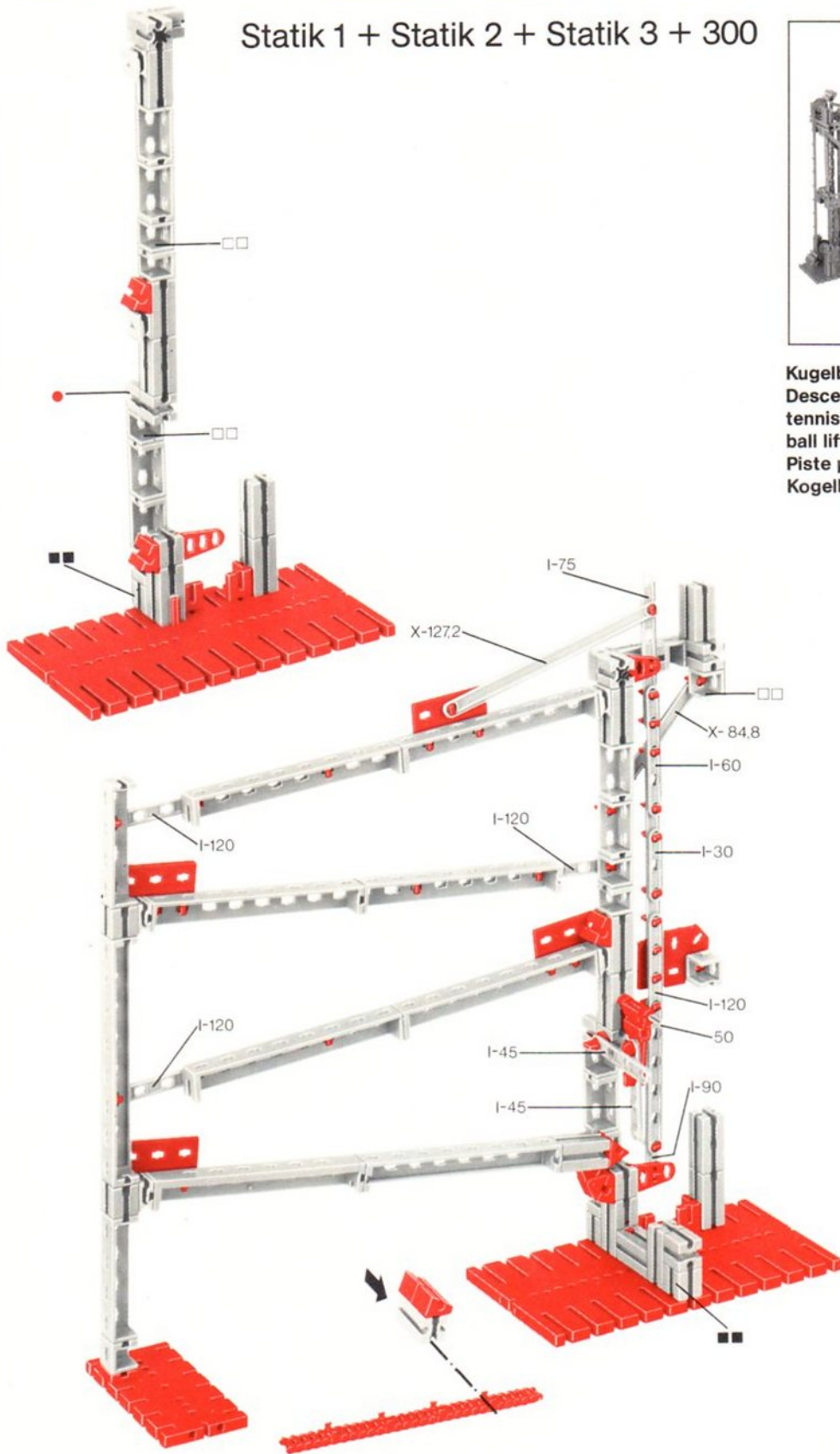

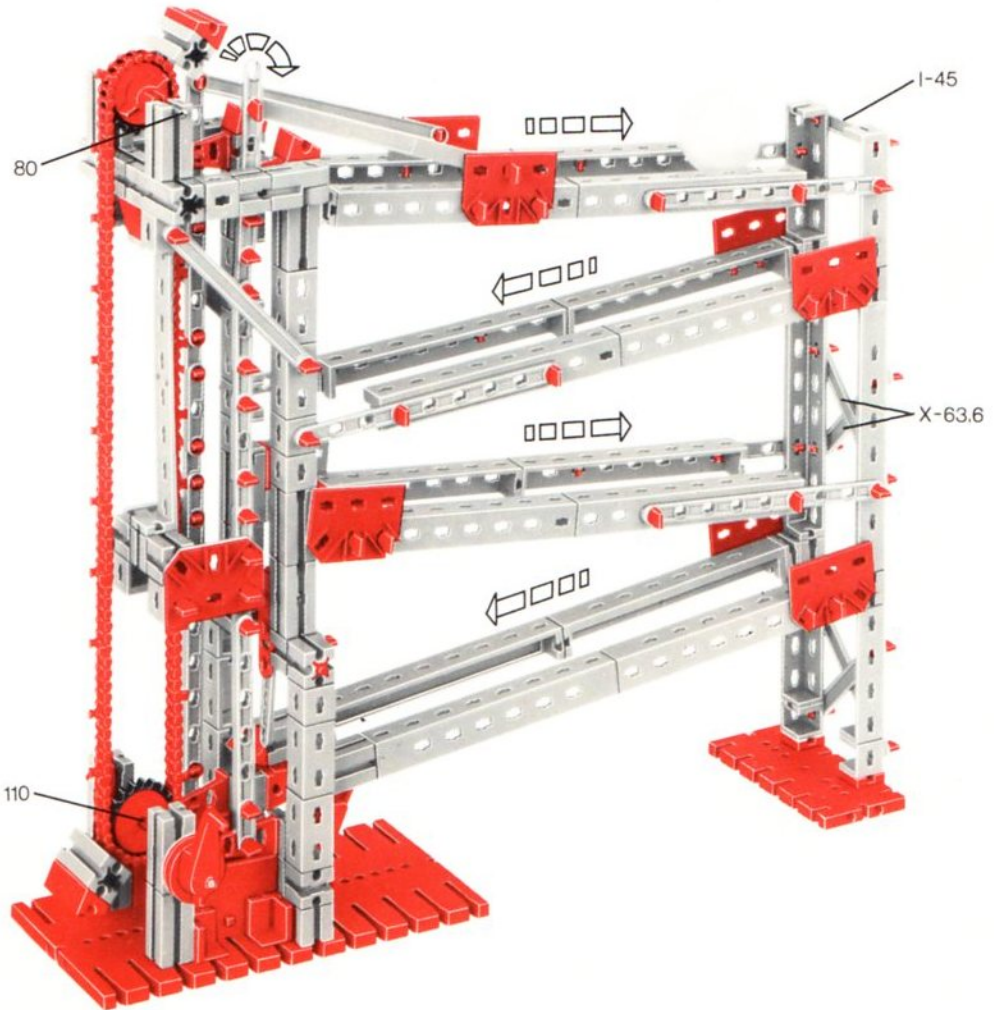

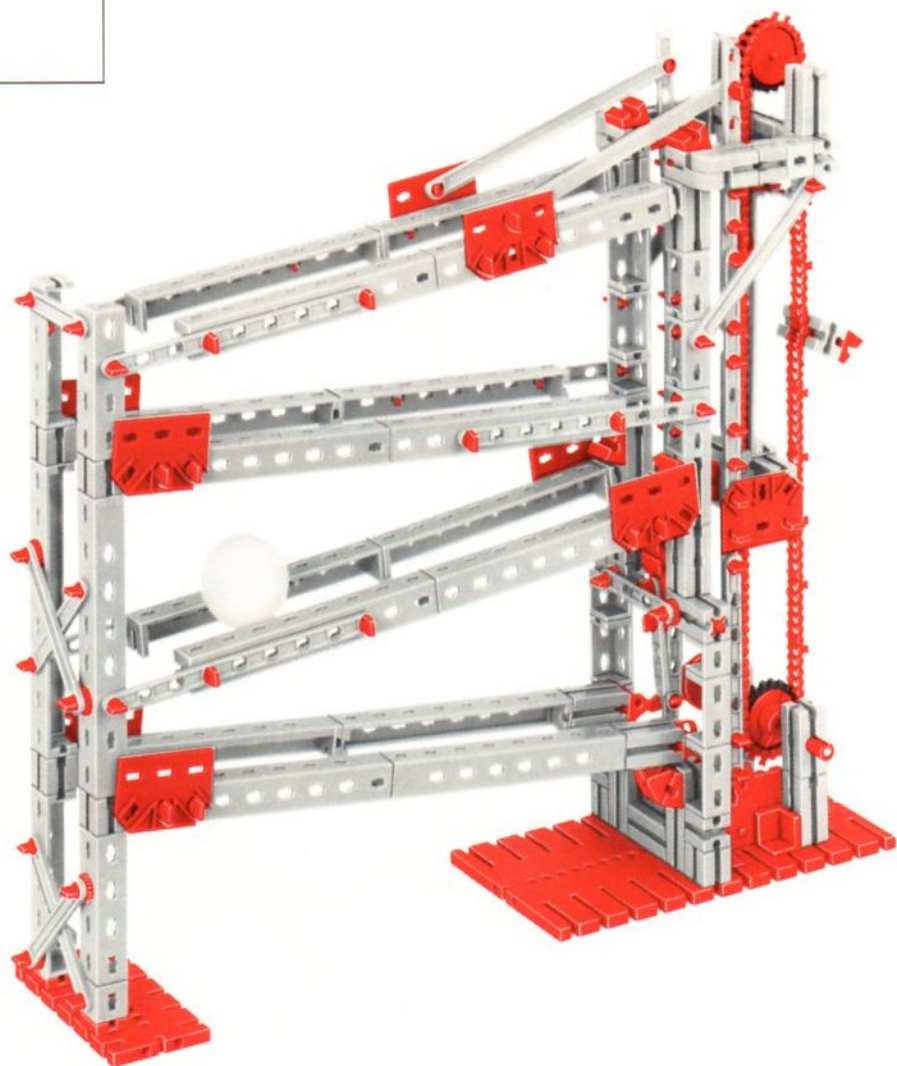

Statik 1 + Statik 2 + Statik 3 + 300

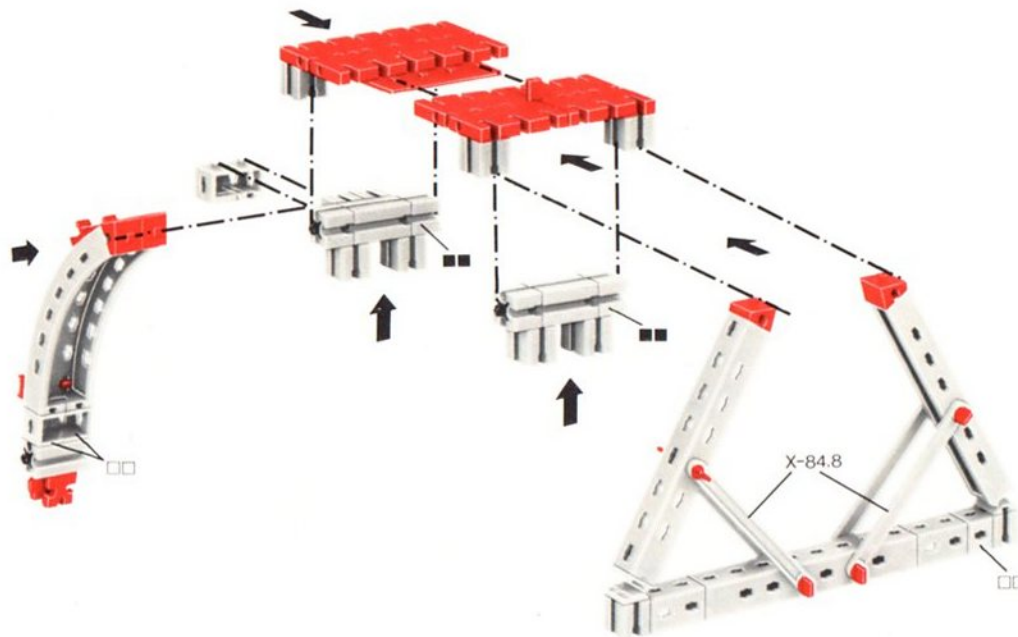



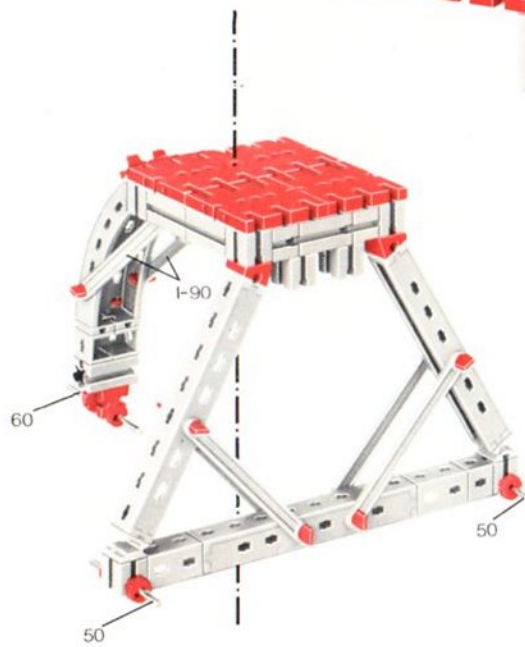

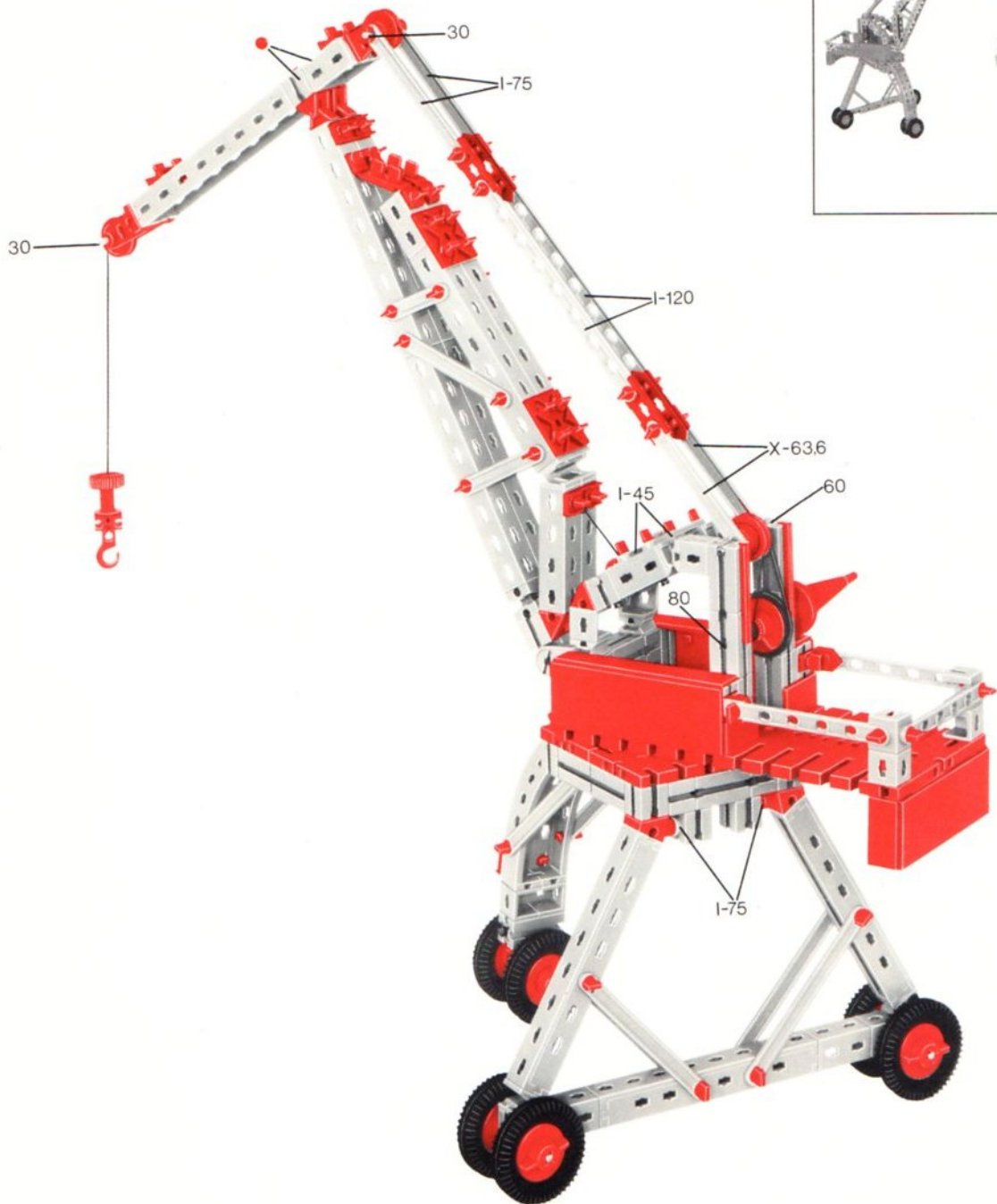























Hafenkran
Dockside crane
Grue pour bateaux
Havenkraan







Stückliste · Parts List · Nomenclature · Onderdelenlijst

	6	Platte 90 x 90 · Panel 90 x 90 · Plaque 90 x 90 · Plaat 90 x 90		4	I-Strebe 45 mit Loch · I-strut 45 with holes · Entretoise type I à perf. mult. de 45 · I-spant 45 met gat
		Art. Nr. 4 35431 1			Art. Nr. 4 38536 1
	4	L-Lasche · L-gusset · Gousset en L · L-verbinding		2	I-Strebe 60 mit Loch · I-strut 60 with holes · Entretoise type I à perf. mult. de 60 · I-spant 60 met gat
		Art. Nr. 4 31572 1			Art. Nr. 4 38535 1
	4	T-Lasche · T-gusset · Gousset en T · T-verbinding		4	I-Strebe 75 mit Loch · I-strut 75 with holes · Entretoise type I à perf. mult. de 75 · I-spant 75 met gat
		Art. Nr. 4 31573 1			Art. Nr. 4 38534 1
	2	Kreuzlasche · Cross gusset · Gousset en croix · Kruisverbinding		4	I-Strebe 90 mit Loch · I-strut 90 with holes · Entretoise type I à perf. mult. de 90 · I-spant 90 met gat
		Art. Nr. 4 31574 1			Art. Nr. 4 38533 1
	4	Adapterlasche · Adapter gusset · Gousset adaptateur · Adapterverbinding		4	I-Strebe 120 mit Loch · I-strut 120 with holes · Entretoise type I à perf. mult. de 120 · I-spant 120 met gat
		Art. Nr. 4 31575 1			Art. Nr. 4 38532 1
	2	Lasche 15 · Connecting strip 15 · Éclisse de 15 · Rechtverbinding 15		4	Winkellasche · Flexible angle strip · Éclisse coudée · Hoekverbinding
		Art. Nr. 4 36326 1			Art. Nr. 4 35738 1
	4	Winkelverbinder 30 · Angel connector 30 · Cornière de reprise de 30 · Haakse verbinding		2	Gelenklasche · Flexible connecting strip · Éclisse articulée · Scharnierstuk
		Art. Nr. 4 31576 1			Art. Nr. 4 36330 1
	4	Eckverbinder · Corner connector · Cornière de reprise d'angle · Hoekstuk		70	S-Riegel 4 · Single rivet 4 mm · Rivet de 4 mm · S-grendel 4 mm
		Art. Nr. 4 31577 1			Art. Nr. 4 36323 1
	4	Winkelträger 15 · Angle girder 15 · Cornière de 15 · Hoekdraagsteun 15		15	S-Riegel 6 · Double rivet 6 mm · Rivet de 6 mm · S-grendel 6 mm
		Art. Nr. 4 36300 1			Art. Nr. 4 36324 1
	4	Winkelträger 30 · Angle girder 30 · Cornière de 30 · Hoekdraagsteun 30		4	S-Riegel 8 · Triple rivet 8 mm · Rivet de 8 mm · S-grendel 8 mm
		Art. Nr. 4 36301 1			Art. Nr. 4 36457 1
	4	Scharnier · Hinge · Charnière · Scharnier		15	Riegelscheibe · Locking washer · Disque d'arrêt · Grendelschijf
		Art. Nr. 4 36329 1			Art. Nr. 4 36334 1
	4	I-Strebe 75 · I-strut 75 · Entretoise type I de 75 · I-spant 75		1	S-Griff · Rivet holder · Tourne-rivet · S-greep
		Art. Nr. 4 36312 1			Art. Nr. 4 35800 1
	4	I-Strebe 120 · I-strut 120 · Entretoise type I de 120 · I-spant 120		1	Kassetten-Unterteil · Cassette, bottom · Coffret, partie inférieure · Cassette, onderstuk
		Art. Nr. 4 36314 1			Art. Nr. 4 35359 1
	8	X-Strebe 106 · X-strut 106 · Entretoise type X de 106 · X-spant 106		1	Kassetten-Deckel · Cassette, top · Coffret, partie supérieure · Cassette, deksel
		Art. Nr. 4 36318 1			Art. Nr. 4 35360 1
	4	I-Strebe 30 mit Loch · I-strut 30 with holes · Entretoise type I à perf. mult. de 30 · I-spant 30 met gat			
		Art. Nr. 4 38537 1			

Modelle aus den fischertechnik
Elektromechanik Baukästen
Models built using the fischertechnik
electro-mechanical construction kits
Modèles réalisés à partir des
boîtes d'électromécanique
Modellen uit de fischertechnik
elektromechanika bouwdoos

